

Version: V1.00.000
Revised date: 12-26-2020

Statement:

All information, specifications and illustrations in this manual are based on the latest information available at the time of release. LAUNCH reserves the rights to make changes at any time without notice.

Copyright Information

Copyright © 2020 by LAUNCH TECH. CO., LTD. All rights reserved. No part of this publication may be reproduced, stored in a retrieval system, or transmitted in any form or by any means, electronic, mechanical, photocopying, recording or otherwise, without the prior written permission of LAUNCH. The information contained herein is designed only for the use of this unit. LAUNCH is not responsible for any use of this information as applied to other units.

Neither LAUNCH nor its affiliates shall be liable to the purchaser of this unit or third parties for damages, losses, costs, or expenses incurred by purchaser or third parties as a result of: Accident, misuse, or abuse of this unit, or unauthorized modifications, repairs, or alterations to this unit, or failure to strictly comply with LAUNCH operating and maintenance instructions. LAUNCH shall not be liable for any damages or problems arising from the use of any options or any consumable products other than those designated as Original LAUNCH Products or LAUNCH Approved Products by LAUNCH.

Trademark Information

LAUNCH is a registered trademark of LAUNCH TECH CO., LTD. (LAUNCH) in China and other countries. All other LAUNCH trademarks, service marks, domain names, logos, and company names referred to in this manual are either trademarks, registered trademarks, service marks, domain names, logos, company names of or are otherwise the property of LAUNCH or its affiliates. In countries where any of the LAUNCH trademarks, service marks, domain names, logos and company names are not registered, LAUNCH claims other rights associated with unregistered trademarks, service marks, domain names, logos, and company names. Other products or company names referred to in this manual may be trademarks of their respective owners. You may not use any trademark, service mark, domain name, logo, or company name of LAUNCH or any third party without permission from the owner of the applicable trademark, service mark, domain name, logo, or company name. You may contact LAUNCH by visiting the website at www.cnlaunch.com, or writing to LAUNCH TECH. CO., LTD., Launch Industrial Park, North of Wuhe Avenue, Banxuegang, Bantian, Longgang, Shenzhen, Guangdong, P.R.China, to request written permission to use Materials on this manual for purposes or for all other questions relating to this manual.

Important Safety Precautions

Important: To avoid personal injury, property damage, or accidental damage to the product, read all of the information in this section before using the product.

- Never collide, throw, or puncture the tool, and avoid falling, extruding and bending it.
- Do not insert foreign objects into or place heavy objects on your device. Sensitive components inside might cause damage.
- Do not use the tool in exceptionally cold or hot, dusty, damp or dry environments.
- In places using the tool may cause interference or generate a potential risk, please turn it off.
- This tool is a sealed unit. There are no end-user serviceable parts inside. All internal repairs must be done by an authorized repair facility or qualified technician. If there is any inquiry, please contact the dealer.
- Never place the tool into apparatus with strong electromagnetic field.
- Keep the tool far away from magnetic devices because its radiations can damage the screen and erase the data stored on the tool.
- **DANGER:** Do not attempt to replace the internal rechargeable lithium battery. Contact the dealer for factory replacement.
- **CAUTION:** Please use the included battery and charger. Risk of explosion if the battery is replaced with an incorrect type.
- Do not disconnect power abruptly when the tool is being formatted or in process of uploading or downloading. Or else it may result in program error.
- Do not delete unknown files or change the name of files or directories that were not created by you, otherwise the tool's apps might fail to work.

Precautions on Using this tool

Before using this test equipment, please read the following safety information carefully.

- Always perform automotive testing in a safe environment.
- If the VCI remains unused for a long period of time, it is suggested to unplug the connector from vehicle's DLC to conserve battery power.
- Wear an ANSI-approved eye shield when testing or repairing vehicles.
- The vehicle shall be tested in a well-ventilated work area, as engines produce various poisonous compounds (hydrocarbon, carbon monoxide, nitrogen oxides, etc.)
- Do not connect or disconnect any test equipment while the ignition is on or the engine is running.
- Put blocks in front of the drive wheels and never leave the vehicle unattended while testing.
- Keep the test equipment dry, clean, free from oil, water or grease. Use a mild detergent on a clean cloth to clear the outside of the equipment as necessary.
- Do not drive the vehicle and operate the test equipment at the same time. Any distraction may cause an accident.
- Keep clothing, hair, hands, tools, test equipment, etc. away from all moving or hot engine parts.
- Before starting the engine, put the gear lever in the Neutral position (for manual transmission) or in the Park (for automatic transmission) position to avoid injury.
- To avoid damaging the test equipment or generating false data, please make sure the vehicle battery is fully charged and the connection to the vehicle DLC (Data Link Connector) is clear and secure.
- Automotive batteries contain sulfuric acid that is harmful to skin. In operation, direct contact with the automotive batteries should be avoided. Keep the ignition sources away from the battery at all times.

Precautions on Operating Vehicle's ECU

- Do not disconnect battery or any wiring cables in the vehicle when the ignition switch is on, as this could avoid damage to the sensors or the ECU.

- Do not place any magnetic objects near the ECU. Disconnect the power supply to the ECU before performing any welding operations on the vehicle.
- Use extreme caution when performing any operations near the ECU or sensors. Ground yourself when you disassemble PROM, otherwise ECU and sensors can be damaged by static electricity.
- When reconnecting the ECU harness connector, be sure it is attached firmly, otherwise electronic elements, such as ICs inside the ECU, can be damaged.

TABLE OF CONTENTS

1 INTRODUCTION	1
1.1 PRODUCT PROFILE.....	1
1.2 PACKAGE LIST (ONLY FOR PASSENGER VEHICLE CONFIGURATION VERSION)2	
1.2 PACKAGE LIST (ONLY FOR GASOLINE & DIESEL CONFIGURATION VERSION)..3	
2 COMPONENTS & CONTROLS.....	5
2.1 DISPLAY TABLET	5
2.2 VCI (ONLY FOR PASSENGER VEHICLE CONFIGURATION VERSION).....	7
2.2 VCI (ONLY FOR GASOLINE & DIESEL CONFIGURATION VERSION).....	8
2.3 TECHNICAL SPECIFICATIONS.....	9
1.3.1 Display tablet	9
1.3.2 VCI (Only for Passenger Vehicle Configuration Version)	10
1.3.2 VCI (Only for Gasoline & Diesel Configuration Version)	10
3 PREPARATIONS.....	11
3.1 CHARGING	11
3.2 USING YOUR BATTERY	11
3.3 POWER ON/OFF.....	11
3.3.1 Power on.....	11
3.3.2 Power off.....	11
3.4 TIPS ON FINGER OPERATIONS	12
3.5 SCREEN LAYOUT	12
3.6 ADJUST BRIGHTNESS	12
3.7 CHANGE SYSTEM LANGUAGE.....	13
3.8 SET STANDBY TIME	13
3.9 NETWORK SETTING	13
3.9.1 Connect to a Wi-Fi Network	13
3.9.2 Disconnect From a Wi-Fi Network.....	14
4 INITIAL USE.....	15
4.1 GETTING STARTED.....	15

4.2 REGISTER & UPDATE.....	15
4.2.1 User registration.....	15
4.2.2 Job menu	18
4.2.3 Vehicle menu layout.....	19
4.2.4 Diagnostics toolbar.....	20
4.3 CONNECTIONS	21
4.3.1 Preparation	21
4.3.2 DLC location	21
4.3.3 Vehicle connection (Only for Passenger Vehicle Configuration Version).....	21
4.3.3 Vehicle connection (Only For Gasoline & Diesel Configuration Version).....	23
4.4 COMMUNICATION SETUP.....	23
5 DIAGNOSIS.....	25
5.1 SMART DIAGNOSIS (AUTODETECT)	25
5.2 MANUAL DIAGNOSIS	31
5.2.1 Health Report (Quick Test)	34
5.2.2 System Scan.....	38
5.2.3 System Selection	39
5.3 TECH 2 TECH.....	50
5.3.1 Interface Layout	51
5.3.2 Add Friends.....	52
5.3.3 Start Instant Messaging.....	53
5.3.4 Launch Remote Diagnosis (Device-To-Device)	55
5.3.5 Launch Remote Diagnosis (Device-To-PC).....	58
5.4 DIAGNOSTIC HISTORY	60
6 DIAGNOSTIC FEEDBACK.....	62
7 SOFTWARE UPDATE	66
7.1 UPDATE DIAGNOSTIC SOFTWARE & APP.....	66
7.2 SET FREQUENTLY USED SOFTWARE.....	67
7.3 RENEW SOFTWARE SUBSCRIPTION.....	67

8 PROFILE	69
8.1 MY REPORT	69
8.1.1 Health Reports	69
8.1.2 Remote Reports	69
8.1.3 ROXIE Reports	70
8.1.4 Recorded Data	70
8.2 VCI MANAGEMENT	71
8.3 ROXIE MANAGEMENT	72
8.4 MY NEWS	73
8.5 DATA STREAM SAMPLE	73
8.6 VEHICLE VOLTAGE	73
8.7 MY ORDER	73
8.8 SUBSCRIPTION RENEWAL CARD	73
8.9 PROFILE	73
8.10 CHANGE PASSWORD	74
8.11 SETTINGS	74
8.11.1 General	74
8.11.2 Shop Information	74
8.11.3 Printer Set	75
8.11.4 Orientation	78
8.11.5 Clear Cache	78
8.11.6 About	78
8.11.7 Login/Logout	78
8.12 DIAGNOSTIC SOFTWARE CLEAR	79
9 SYNCHRONIZATION	80
10 FAQ	81

1 Introduction

1.1 Product Profile

This tool is a new Android-based vehicle diagnostic tool. It is characterized by featuring powerful functions, and providing precise test result.

Through Bluetooth communication between the VCI (Vehicle Communication Interface) and display tablet, it achieves full car model and full system vehicle trouble diagnosis, which include Reading DTCs, Clearing DTCs, Reading Data Stream, Actuation Test and Special Functions.

This tool adopts a higher performance-price ratio display tablet, which comes loaded with the Android 9.0 operating system, 10.1" IPS touch screen with a resolution of 1920 x 1200 pixels.

It has the following features and advantages:

- **Diagnose**: AutoDetect and manual diagnosis are available. Diagnosis functions include: Read DTCs, Clear DTCs, Read Data Stream, Special Functions etc.
- **I/M Readiness**: I/M refers to Inspection and Maintenance that is legislated by the Government to meet federal clean-air standards. I/M Readiness indicates whether or not the various emissions-related systems on the vehicle are operating properly and are ready for Inspection and Maintenance testing.
- **Tech 2 Tech**: This option aims to help repair shops or technicians launch instant messaging and remote diagnosis, making the repair job getting fixed faster.
- **One-click Update**: Lets you update your diagnostic software online.
- **Diagnostic feedback**: Enables you to submit the vehicle issue to us for analysis and troubleshooting.
- **Repair Info**: Multiple speed dial to professional repair website are available for helping repair professionals diagnose and repair vehicle efficiently, accurately and profitably.
- **Vehicle Coverage**: Enables you to quickly check which vehicle models are supported.

1.2 Package List (Only for Passenger Vehicle Configuration Version)

Common accessories are same, but for different destinations, the accessories (such as diagnostic software, testing connectors) may vary. Please consult from the local agency or check the package list supplied with the tool together.

No.	Item	Descriptions	Qt.
1	Display tablet	Indicates the test result.	1
2	VCI	Collects vehicle data and sends it to the tablet for analysis.	1
3	OBD II extension cable	Connects the VCI to the OBD II vehicle's DLC.	1
4	Password envelope	A piece of paper bearing the product Serial Number and Activation Code for product registration.	1
5	Power adaptor	For charging the tablet via AC outlet.	1
6	Battery clamps cable	To supply power to the non-16pin connector from the vehicle's battery.	1
7	Cigarette lighter cable	To supply power to the non-16pin connector from the vehicle's cigarette lighter receptacle.	1
8	USB cable	Connects the power adaptor to charge the tablet.	1
9	OBD I adaptor box	For connecting the VCI and non-16pin adaptor cable.	1
10	Quick Start Guide		1
11	Non-16pin adaptor	For different vehicle diagnostic	(Optional)

	cable kit	sockets, it may be necessary to use one of the adapter cables included within the kit. For detailed adapter cables, please check the package box.	
--	-----------	---	--

1.2 Package List (Only for Gasoline & Diesel Configuration Version)

Common accessories are same, but for different destinations, the accessories (such as diagnostic software, testing connectors) may vary. Please consult from the local agency or check the package list supplied with the tool together.

No.	Item	Descriptions	Qt.
1	Display tablet	Indicates the test result.	1
2	VCI	Collects vehicle data and sends it to the tablet for analysis.	1
3	Diagnostic cable	Connects the VCI to the OBD II vehicle's DLC.	1
4	Password envelope	A piece of paper bearing the product Serial Number and Activation Code for product registration.	1
5	Power adaptor	For charging the tablet via AC outlet.	1
6	Battery clamps cable	To supply power to the non-16pin connector from the vehicle's battery.	1
7	Cigarette lighter cable	To supply power to the non-16pin connector from the vehicle's cigarette lighter receptacle.	1
8	Data cable	Connects the VCI module to the tablet to perform vehicle diagnosis.	1

9	Quick Start Guide		1
11	Non-16pin adaptor cable kit (For passenger vehicles)	For different vehicle diagnostic sockets, it may be necessary to use one of the adapter cables included within the kit. For detailed adapter cables, please check the package box.	(Optional)
12	Non-16pin adaptor cable kit (For commercial vehicles)	For different vehicle diagnostic sockets, it may be necessary to use one of the adapter cables included within the kit. For detailed adapter cables, please check the package box.	(Optional)

2 Components & Controls

There are two main components to the diagnostic system:

- Display tablet – the central processor and monitor for the system (See Chapter 2.1).
- VCI – the device for accessing vehicle data (See Chapter 2.2).

2.1 Display Tablet

The tablet acts as the central processing system, which is used to receive and analyze the live vehicle data from the VCI and then output the test result.

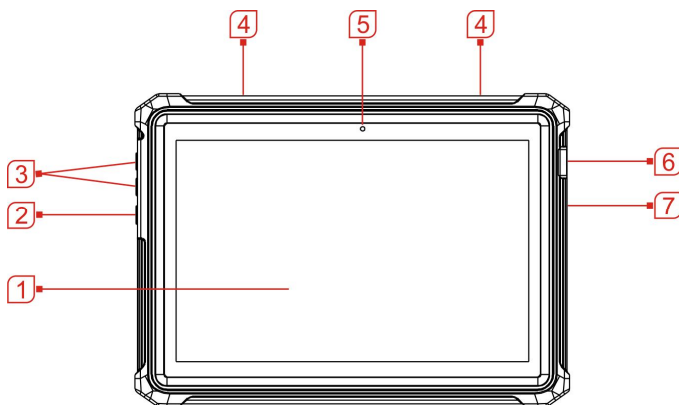

1 **LCD Screen** Indicates the test results.

2 **POWER Key**

In Off mode, press it for 3 seconds to turn the tablet on.

In On mode:

- Press and hold it for 3 seconds to turn it off or restart it.
 - Press and hold it for 10 seconds to perform
-

forced shutdown and restart.

-
- | | | |
|---|-------------------|----------------------------|
| 3 | Volume +/- | Adjusts the system volume. |
|---|-------------------|----------------------------|
-
- | | | |
|---|-----------------|--|
| 4 | Speakers | |
|---|-----------------|--|
-
- | | | |
|---|---------------------|--|
| 5 | Front Camera | |
|---|---------------------|--|
-
- | | | |
|---|--------------------------|---|
| 6 | USB/Charging Port | <ul style="list-style-type: none">• To connect to AC outlet for charging.• To connect to PC for data exchange. |
|---|--------------------------|---|
-
- | | | |
|---|-------------------|--|
| 7 | Microphone | |
|---|-------------------|--|
-

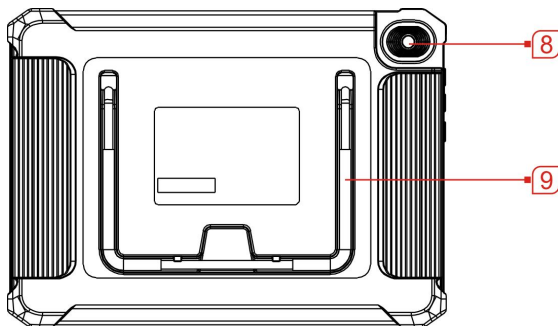

-
- | | | |
|---|--------------------|--|
| 8 | Rear Camera | |
|---|--------------------|--|
-
- | | | |
|---|-------------------------|---|
| 9 | Adjustable stand | Flip it out to any angle and work comfortable at your desk, or hang it on steering wheel. |
|---|-------------------------|---|
-

2.2 VCI (Only for Passenger Vehicle Configuration Version)

The VCI works as a vehicle communication interface device, which is used to connect to the vehicle's DLC (Data Link Connector) socket directly or via OBD II extension cable to read the vehicle data and then send it to the tablet via Bluetooth.

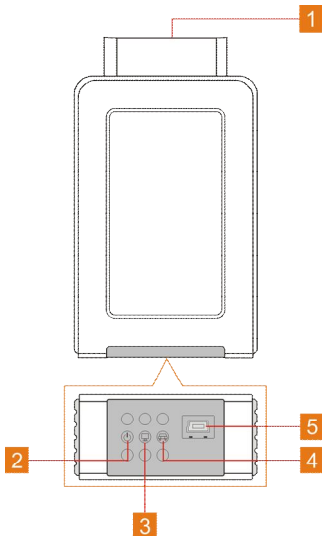

1	OBD-16 diagnostic connector	To connect on vehicle's OBD II DLC.
2	Power indicator	It lights up while the VCI is plugged into the vehicle's DLC.
3	Bluetooth/USB communication indicator	<ul style="list-style-type: none"> It indicates Bluetooth mode if the VCI is energized and illuminates blue (default mode). It illuminates red when the VCI is connected to the diagnostic tool via USB cable (The USB port is temporarily disabled).

- | | | |
|---|------------------------------------|---|
| 4 | ECU communication indicator | It flashes when the connector is communicating with the vehicle. |
| 5 | USB port | This port is temporarily disabled and reserved for subsequent function extension. |

2.2 VCI (Only for Gasoline & Diesel Configuration Version)

Compatible with Passenger & Commercial vehicles, the VCI module works as a vehicle communication interface device. It is used to read the vehicle data and then send it to the tablet via wireless (BT) communication or data cable connection. The LED indicators enable you to easily identify the working status of the module.

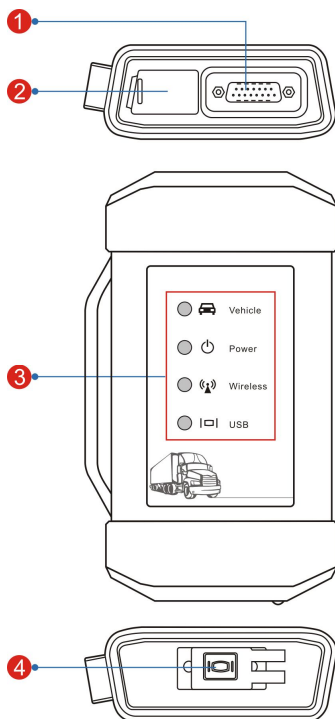

1	Diagnostic socket	Connects the diagnostic cable.
2	DC-IN power jack	Connects the power adaptor.
3	LED Indicators	<p>It is defined as follows:</p> <ul style="list-style-type: none"> • <u>Vehicle</u>: While communicating with the vehicle, the indicator lights up and flashes. Otherwise, it will not illuminate. • <u>Power</u>: It illuminates solid red when the module is powered on. • <u>Wireless (BT)</u>: Blue indicates the module is working in Bluetooth mode. • <u>USB</u>: It lights up when the module is connected to the diagnostic tool via data cable.
4	Data Transmission port	Connects the VCI module to the tablet via data cable to perform vehicle diagnosis.

2.3 Technical Specifications

1.3.1 Display tablet

Operating system	Android
Memory	3GB
Storage	32GB
Screen	10.1 inch FHD IPS capacitive touch screen with a resolution of 1920 x 1200 pixels
Camera	Front-facing 5.0MP + Rear-facing 8.0MP camera
Connectivity	<ul style="list-style-type: none"> • Wi-Fi (802.11a/b/g/n/ac) • Bluetooth

Working temperature	0°C ~ 50°C
---------------------	------------

Storage temperature	-20°C ~ 70°C
---------------------	--------------

1.3.2 VCI (Only for Passenger Vehicle Configuration Version)

Working voltage	DC 9 ~18V
-----------------	-----------

Average working current	About 128mA
-------------------------	-------------

Standby current	About 50mA
-----------------	------------

Working temperature	0 to 55°C
---------------------	-----------

Storage temperature	-20 to 70°C
---------------------	-------------

Storage humidity	<80%
------------------	------

Working humidity	<60%
------------------	------

1.3.2 VCI (Only for Gasoline & Diesel Configuration Version)

Working voltage	DC 9~36V
-----------------	----------

Power consumption	≤ 2W
-------------------	------

Communication	Via Bluetooth or data cable connection
---------------	--



Working temperature	0°C ~ 50°C
---------------------	------------

Bluetooth module	YG-218M-A2
	<ul style="list-style-type: none">• Frequency range: 2402-2480MHz• Transmit power: 16.62dBm

3 Preparations

3.1 Charging

1. Plug one end of the included charging port of the tool, and the other end to the power adaptor.
2. Connect the other end to the AC outlet.

If  appears on the screen, it indicates it is being charged. If the logo changes into , it indicates that the battery is fully charged. Unplug the power adaptor from the tablet.

3.2 Using your battery

- ♦ If the battery remains unused for a long period of time or the battery is completely discharged, it is normal that the tool will not power on while being charged. Please charge it for a period of 5 minutes and then turn it on.
- ♦ Please use the included power adaptor to charge your tool. No responsibility can be assumed for any damage or loss caused as a result of using power adaptors other than the one supplied.
- ♦ While the tablet has low battery, a beep will sound. If it is very low, the tablet will be switched off automatically.

3.3 Power on/off

3.3.1 Power on

Press [POWER] to turn the tool on.

Note: If it is the first time you have used this tool or the tool remains idle for a long period of time, the tool could fail to turn on. Please charge the tool for a minimum of 5 minutes and attempt to turn on again.







3.3.2 Power off

Press [POWER] for 3 seconds, an option menu will pop up on the screen.

Tap  **Power off** to turn the tool off. Tap  **Restart** to reboot the tool.





Press [POWER] for about 10 seconds to perform a forced shutdown and restart.

3.4 Tips on finger operations

	Single-tap: To select a item or launch a program.
	Double-tap: To zoom in so that the text on a webpage appears in a column that fits your device's screen.
	Long press: Tap and hold on the current interface or area until a contextual menu pops up on the screen, and then release it.
	Slide: To jump to different pages.
	Drag: Tap the desktop icon and drop it to other location.
	Spread apart/pinch together: To zoom in manually, place two fingers on the screen and then spread them apart. To zoom out, place two fingers apart on the screen and then pinch them together.

3.5 Screen Layout

The following on-screen buttons are available on the bottom of the screen.

 BACK	Tap it to return to the previous screen.
 HOME	Tap it to navigate to the Android's home screen.
 Recent Apps	Tap it to view the recently launched applications.
 Screenshot	Tap it to capture the current screen.

3.6 Adjust Brightness

 **Tips:** Reducing the brightness of the screen is helpful to conserve the battery power.

1. On the home screen, tap **Settings -> Display -> Brightness level**.
2. Drag the slider to adjust it.

3.7 Change System Language

The tool supports multiple system languages. To change the language of the tool, please do the following:

1. On the home screen, tap **Settings -> System -> Language & input -> Languages**.
2. Tap **Add a language**, and then choose the desired language from the list.
3. Tap and hold the desired language and drag it to the top of the screen and then release it, the system will change into the target language.

3.8 Set Standby Time

If no activities are made within the defined standby period, the screen will be locked automatically and the system enters sleep mode to save power.

1. On the home screen, tap **Settings -> Display -> Advanced -> Sleep**.
2. Choose the desired sleep time.

3.9 Network Setting

Note: If you don't need to use Wi-Fi for a while, you can turn it off to conserve battery life.

The tablet has built-in Wi-Fi that can be used to get online. Once you're online, you can register your tool, surf the Internet, get apps, send email, launch the remote diagnosis, and check for software updates etc.

3.9.1 Connect to a Wi-Fi Network

1. On the home screen, tap **Settings -> Network & Internet -> WLAN**.
2. Slide the Wi-Fi switch to ON, the tablet starts searching for available wireless networks.
3. Select a wireless network,
 - If the chosen network is open, the tablet will connect automatically.
 - If the selected network is encrypted, a network password will need to be entered.

4. When *Connected* appears, it indicates the Wi-Fi connection is complete.

Note: When Wi-Fi is not required, this should be disabled to conserve battery power.

Once it is connected successfully, tap the desired Wi-Fi network from the list to view its name, link speed, security type, IP address etc.

When this tool is in range, it will connect to the previously linked network automatically.

3.9.2 Disconnect From a Wi-Fi Network

1. On the home screen, tap **Settings -> Network & Internet -> WLAN**.
2. Tap the network with a **Connected** status, then tap **Disconnect**.

4 Initial Use

4.1 Getting Started

For new users, please follow the operation chart shown below to start using this tool.

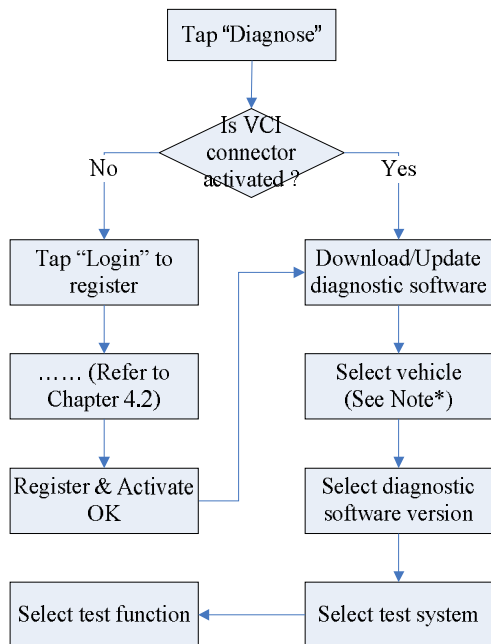

Note: If *AutoDetect* function is performed, this step shall not apply.

4.2 Register & Update

4.2.1 User registration

On the home screen, tap the application icon to launch it, a dialog box similar to the following will pop up on the screen:

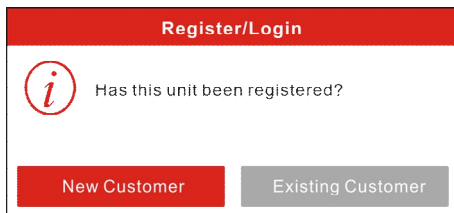

The screen has a red header with the text "Register/Login". Below the header is a white area containing an information icon (a lowercase 'i' in a red circle) and the text "Has this unit been registered?". At the bottom of this area are two buttons: a red button labeled "New Customer" and a grey button labeled "Existing Customer".

- A. If you are a new user and want to register your tool directly, tap **New Customer** to start your sign-up.

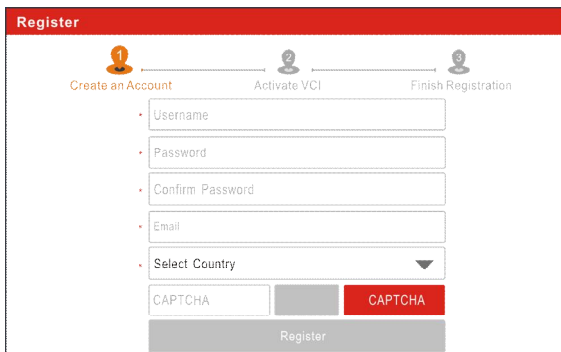

The screen has a red header with the text "Register". Below the header is a progress indicator with three steps: "1 Create an Account" (highlighted with a yellow circle), "2 Activate VCI", and "3 Finish Registration". Below the progress indicator are several input fields: "Username", "Password", "Confirm Password", "Email", and "Select Country" (with a dropdown arrow). Below these fields are two CAPTCHA boxes, one grey and one red. At the bottom is a large grey button labeled "Register".

- a) Create App Account: Fill in the information in each field (Items with * must be filled). After inputting, tap **Register**, a screen similar to the following will appear:

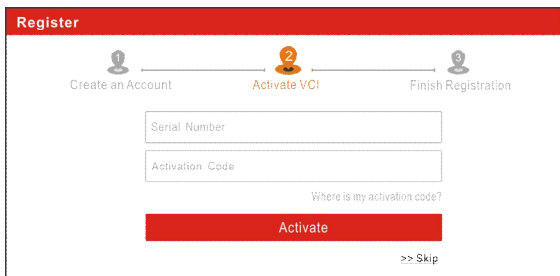

The screen has a red header with the text "Register". Below the header is a progress indicator with three steps: "1 Create an Account", "2 Activate VCI" (highlighted with a yellow circle), and "3 Finish Registration". Below the progress indicator are two input fields: "Serial Number" and "Activation Code". Below these fields is the text "Where is my activation code?". At the bottom is a large red button labeled "Activate". In the bottom right corner, there is a link that says ">> Skip".

- b) Activate VCI: Input the Serial Number and Activation Code, which can be found in the password envelope.

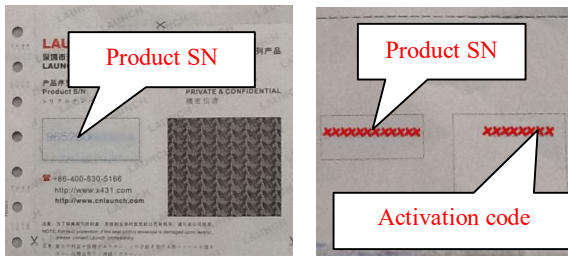

Note: To exit and activate it later, tap **Skip**. In this case, please activate the VCI by tapping **Profile** -> **VCI Management** -> **Activate VCI**. For details, please refer to Chapter 9.2.

Tap **Activate** to finish the registration process.

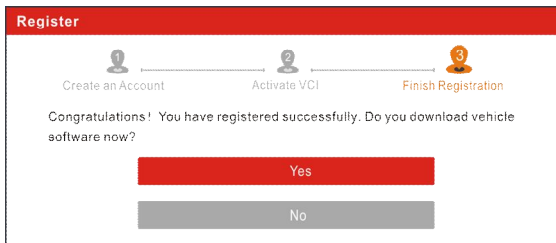

c) Finish Registration: To download the diagnostic software, tap **Yes** to navigate to the download page. Tap **No** to download and install it later.

On the download page, tap **Update** to start downloading. To pause downloading, tap **Stop**. To resume it, tap **Continue**. Once download is complete, the system will install the software package automatically.

Note: In process of download, please make sure the tablet has a strong Wi-Fi signal. It may take several minutes to finish it, please be patient to wait.

B. If you have registered to be a member, tap **Existing Customer**, a screen similar to the following appears:

(If you have registered to be a member, go to **a**) to login the system directly.)

(In case you forgot password, refer to **b**) to reset a new password.)

- a) If you have registered to be a member, input your name and password, and then tap the **Login** button to enter the main menu screen directly.

Note: The tablet has an auto-save function. Once the username and password are correctly entered, the system will automatically store it. Next time you login the system, you will not be asked to input the account manually.

- b) If you forgot the password, tap **Retrieve password** and then follow on-screen instructions to set a new one.

4.2.2 Job menu

It mainly includes the following items:

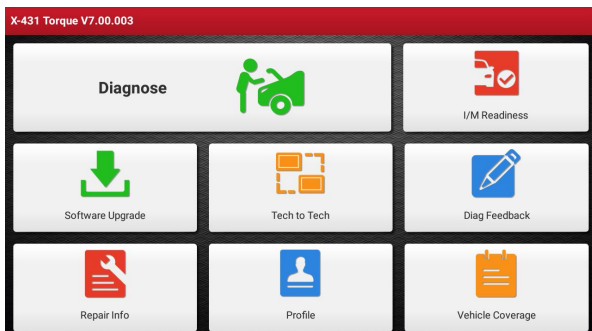

Name	Description
Diagnose	Configures the tablet as a professional diagnostic tool.

I/M Readiness	I/M Readiness indicates whether or not the various emissions-related systems on the vehicle are operating properly and are ready for Inspection and Maintenance testing.
Software Upgrade	Updates vehicle diagnostic software and APK.
Tech 2 Tech	This option aims to help repair shops or technicians launch instant messaging and remote diagnosis, making the repair job getting fixed faster.
Diag. Feedback	To feed back the recent 20 diagnostic logs to us for issue analysis.
Repair Info	Provides quick access to various authorized automotive repair database.
Profile	To manage VCI, reports, change password, configure printer, system settings and logout etc.
Vehicle Coverage	To view all the vehicle models that the tablet covers.

4.2.3 Vehicle menu layout

After downloading the diagnostic software, please go to **Diagnose** to check if all software are completely downloaded and installed.

Tap **Diagnose**, the following screen will appear:

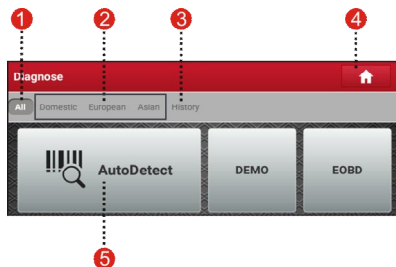





1	All Tab: Displays all the vehicle makes in the vehicle menu.
2	Vehicle region buttons: Tap different buttons to switch to corresponding vehicles.

3	Generally once a vehicle diagnosis is performed, the tablet will record the every details of diagnostic session. The History function provides direct access to the previously tested vehicles and users can resume from the last operation, without starting from scratch.
4	 Home Button: Returns to the Job menu.
5	Auto Detect: Obtains vehicle data from the cloud server to perform quick test via reading VIN, to avoid various defects resulting from step-by-step menu selection.

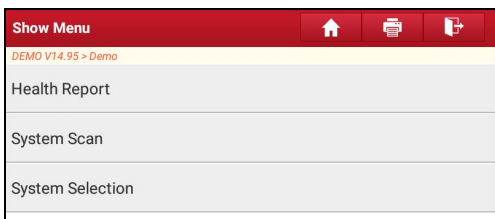
4.2.4 Diagnostics toolbar

The diagnostics toolbar contains a number of buttons that allow you to print the displayed data or make other controls. It is displayed on the upper right corner of the screen and goes through the whole diagnostic session. The table below provides a brief description for the operations of the diagnostics toolbar buttons:



Name	Button	Description
Home		Returns to Job menu screen.
Print		Tap to print the current screen. To perform printing, you need to purchase an extra Wi-Fi printer manufactured by LAUNCH or other manufacturers separately and then properly configure the wireless printer following the steps described in Chapter 9.11.3.
Exit		To exit the diagnostic application.

4.3 Connections

4.3.1 Preparation

Normal testing conditions

- The ignition is turned on.
- The vehicle battery voltage is 9~18V.
- The throttle is in a closed position.

4.3.2 DLC location

The DLC (Data Link Connector) is typically a standard 16 pin connector where diagnostic code readers interface with the vehicle's on-board computer. The DLC is usually located 12 inches from the center of the instrument panel (dash), under or around the driver's side for most vehicles. If Data Link Connector is not located under dashboard, a label should be there telling location. For some Asian and European vehicles, the DLC is located behind the ashtray and the ashtray must be removed to access the connector. If the DLC cannot be found, refer to the vehicle's service manual for the location.

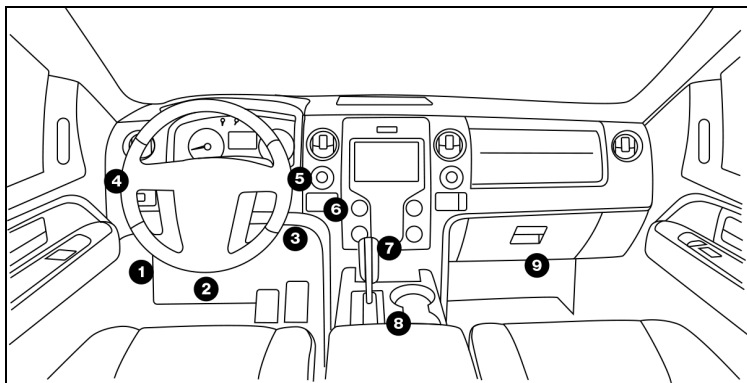

4.3.3 Vehicle connection (Only for Passenger Vehicle Configuration Version)

The method used to connect the VCI to a vehicle's DLC depends on the vehicle's configuration as follows:

- A vehicle equipped with an OBD II management system supplies both communication and 12V power through a standardized DLC.

- A vehicle not equipped with an OBD II management system supplies communication through a DLC connection, and in some cases supplies 12V power through the cigarette lighter receptacle or a connection to the vehicle battery.

Follow the steps mentioned below to connect OBD II vehicle:

1. Locate vehicle's DLC socket.
2. Plug the VCI into the vehicle's DLC socket (It is suggested to use the OBD II extension cable to connect the VCI and DLC socket.).
3. Choose one of the two ways to obtain power from:
 - A. Power adaptor: Connect one end of the included power adaptor to the charging port of display tablet, and the other end to AC outlet.
 - B. Internal battery pack

For non-OBDII vehicle, proceed as follows:

1. Locate vehicle's DLC socket.
2. Select the corresponding non-16pin connector.
3. Plug the non-16pin end of the connector into the DLC socket, and the other end to the OBD I adaptor, and then tighten the captive screws.
4. Connect the other end of the adaptor to the included VCI.
5. To supply power to OBD I adaptor from:

A. Cigarette Lighter Cable (optional): Connect one end of the cigarette lighter cable to vehicle's cigarette lighter receptacle, and the other end to the power jack of OBD I adaptor.

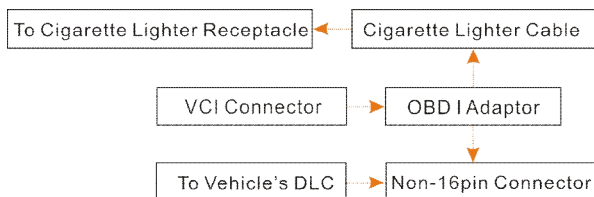

B. Battery Clamps Cable (optional): Connect one end of the battery clamps cable to vehicle's battery, and the other end to the power jack of OBD I adaptor.

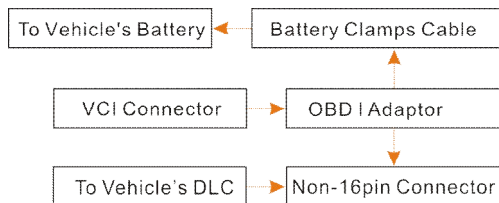

4.3.3 Vehicle connection (Only For Gasoline & Diesel Configuration Version)

The method used to connect the VCI module to a vehicle's DLC depends on the vehicle's configuration as follows:

- A. **OBD II Vehicle Connection:** Plug one end of the diagnostic cable into the vehicle's DLC, and the other end into the diagnostic socket of the VCI module, and then tighten the captive screws.



- B. **Non-OBD II Vehicle Connection:** For vehicles with non-OBD II diagnostic socket, a non-16pin connector (adaptor cable) is required.

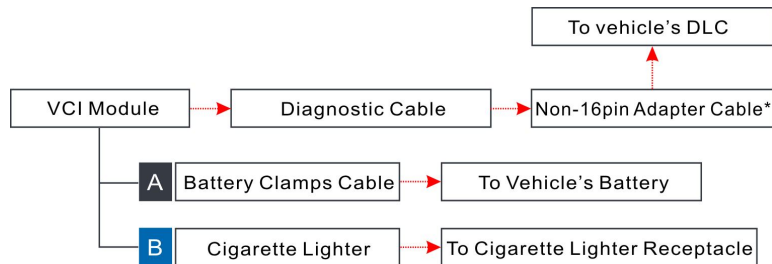

*Notes:

- For commercial vehicles, refer to the above connection method to proceed.
- For passenger vehicles, replace the "Non-16pin connector" with "OBD I adaptor" + "non-16pin connector (for passenger vehicles)". Other connections shall also apply.

4.4 Communication Setup

After the VCI is successfully activated and powered on, the VCI will pair with the

tablet automatically. Users have no need to make any setting any more.

Once the communication failure occurs, the diagnostic app will pop up some prompt information. In this case, just follow the on-screen prompts to troubleshoot all possible causes.

5 Diagnosis

Three methods are available for vehicle diagnosis: Smart Diagnosis (AutoDetect), Manual Diagnosis and Tech to Tech Remote Diagnosis.

Tap **Diagnose** on the Job Menu to enter the Diagnose main menu.

5.1 Smart Diagnosis (AutoDetect)

Through simple Bluetooth communication between the display tablet and VCI, you can easily get the VIN (Vehicle Identification Number) information of the currently identified vehicle. Once the VIN is successfully identified, the system will retrieve it from the remote server and then guide you to vehicle information page without step-by-step manual menu selection.

The vehicle information page lists all historical diagnostic records of the vehicle, which lets the technician have a total command of the vehicle faults. In addition, a quick dial to local diagnosis and diagnostic function are also available on this page for reducing the roundabout time and increasing productivity.

Notes:

- Before using this function, please make sure the VCI is properly connected to the vehicle's DLC. For detailed connection, see Chapter 4.3.3 Vehicle Connection.
- A stable network connection is required for this function.

Follow the steps below to proceed.

1. Tap **AutoDetect** on the Diagnose main menu screen.

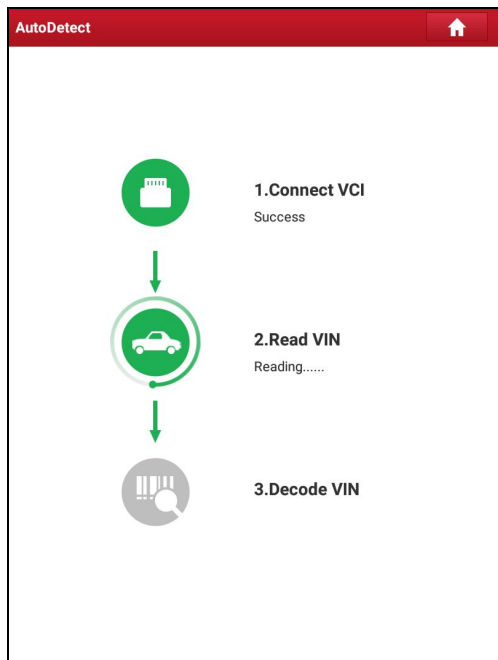

Note: If the VCI is not paired up with the tablet before doing this step, a prompt message box will appear on the screen. Check all the possible reasons of Bluetooth connection failure carefully, and then tap **OK** to the following screen.

Check all the possible reasons of Bluetooth connection failure carefully, and then tap **Confirm** to enter the following screen.

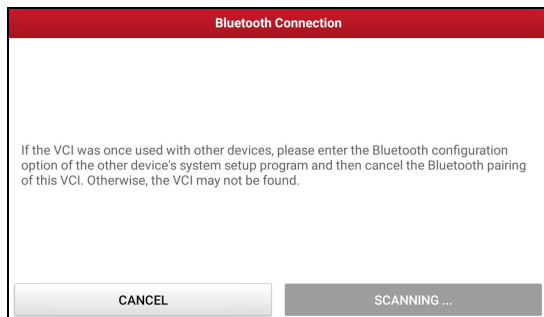

If the VCI was once used with other devices, please go to **Profile -> VCI Management -> Deactivate matching** to cancel the pairing of the VCI.

Tap **Scan** to start searching for the VCI and pairing up with it.

2. Once pairing is complete, the tablet starts reading the vehicle VIN.

A. If the VIN can be found from the remote server database, the vehicle information screen will display.

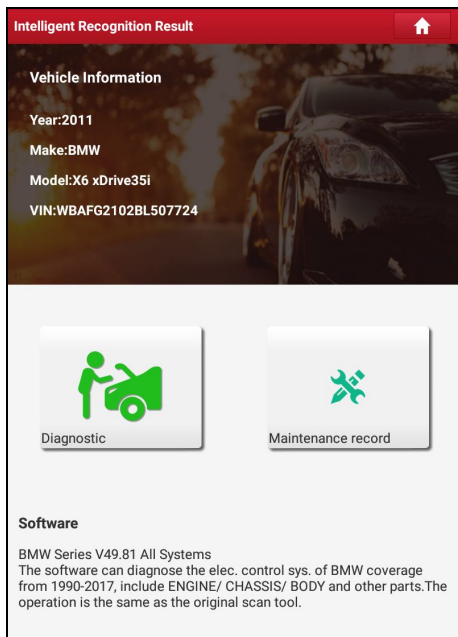

- Tap **Diagnostic** to start a new diagnostic session.
- Tap **Maintenance record** to view its historical repair record. If there are records available, it will be listed on the screen in sequence of date. If no records exist, the screen will show *No Record*.

Maintenance record 			
2017 10/16	Number of diagnostic systems:34 Number of DTCs:0	17:48:39	View record
	Number of diagnostic systems:34 Number of DTCs:2	14:15:46	View record
	Number of diagnostic systems:4 Number of DTCs:0	11:49:48	View record
	Number of diagnostic systems:6 Number of DTCs:0	11:47:31	View record
2017 10/14	Number of diagnostic systems:34 Number of DTCs:2	09:35:25	View record
2017 10/11	Number of diagnostic systems:1 Number of DTCs:0	11:43:13	View record
	Number of diagnostic systems:34 Number of DTCs:2	09:12:23	View record
2017 09/30	Number of diagnostic systems:34 Number of DTCs:2	14:51:40	View record
BMW X6 xDrive35i 2011 VIN WBAF62102BL507724			Quick access

- Tap **View record** to view the details of the current diagnostic report.
- To perform other functions, tap **Quick access** to directly go to the function selection screen. Choose the desired one to start a new diagnostic session.

B. If the tablet failed to access the VIN information, the screen will display as below:

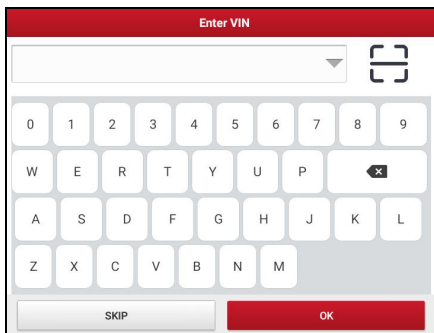

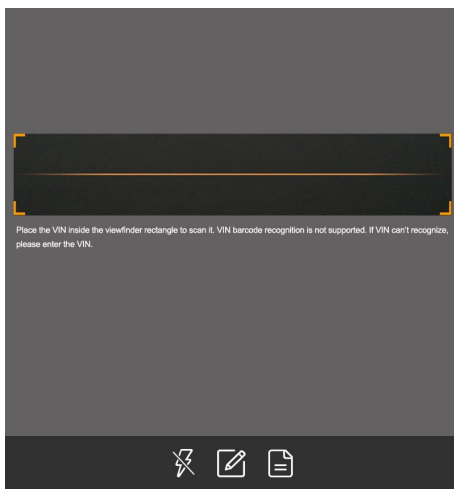

In this mode, you need to input the VIN manually or tap  to scan it.

- 1) Tap  to launch the VIN recognition module.



Place the VIN inside the viewfinder rectangle to scan it. The most recognizable location for this number is in the top left corner on the vehicle's dashboard. Other locations include the driver's door or post, and the firewall under the hood.

- If you have scanned the VIN of the vehicle, tap  to choose it from the record list.

- In case the tablet failed to detect it, tap  to enter it manually.
- To turn the flash on, tap .

After scanning, the screen automatically displays the result.

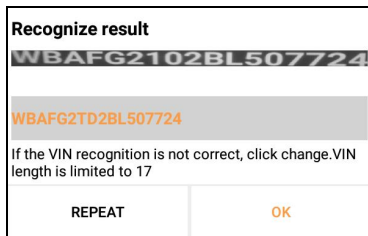

- If the VIN scanned is incorrect, tap the result field to modify it and then tap **OK**. If the VIN exists on the remote server, the system will enter the vehicle information screen.
 - To scan it again, tap **REPEAT**.
- 2) Input the VIN, and tap **OK**, the system will automatically identify the vehicle model and directly navigate to the vehicle information page.

In general, vehicle identification numbers are standardized - all contain 17 characters. VIN characters may be capital letters A through Z and numbers 1 through 0; however, the letters I, O and Q are never used in order to avoid mistakes of misreading. No signs or spaces are allowed in the VIN.

Tap **SKIP** to go to **Diagnose** main menu screen.

5.2 Manual Diagnosis

In this mode, you need to execute the menu-driven command and then follow the on-screen instruction to proceed.

Take Demo as an example to demonstrate how to diagnose a vehicle.

- 1). Select diagnostic software version: Tap the **DEMO** to go to Step 2. (Note: If more than one version is available on the tablet, it will be listed on the screen.)

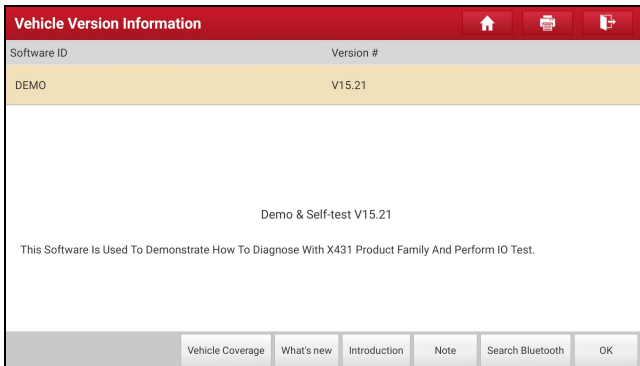

On-screen Buttons:

Vehicle Coverage: Tap to view the vehicle models that the current diagnostic software covers.

What's new: Tap to view the optimized items and enhancements.

Introduction: Tap to check the software function list.

Note: Tap to read some precautions on using the current diagnostic software.

Search Bluetooth: Tap to search for the available VCI. After the VCI is successfully activated, it will be bound to the user account and paired with the tablet automatically.

Note: No Bluetooth connection is required for DEMO program.

OK: Tap it to go to next step.

2). **Select vehicle model (varies with different versions):** Select the desired vehicle model. Here we take **Ford** for example to demonstrate how to diagnose a vehicle.

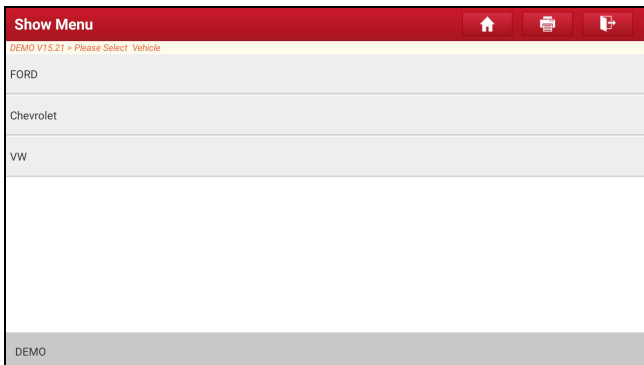

- 3). Read vehicle information: After reading the vehicle information, double check if the vehicle information is correct or not. If yes, tap **Yes** to continue.

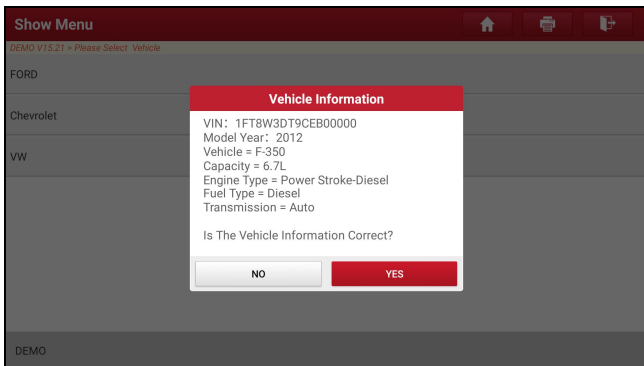

- 4). Select test item: Select the desired test item to proceed.

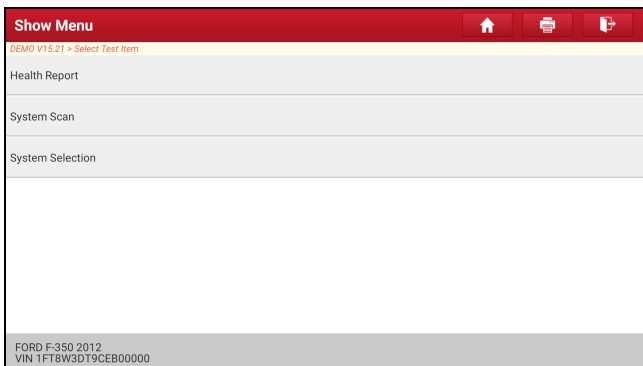

5). Turn the ignition key to ON: Set the ignition switch to on and tap **OK**.

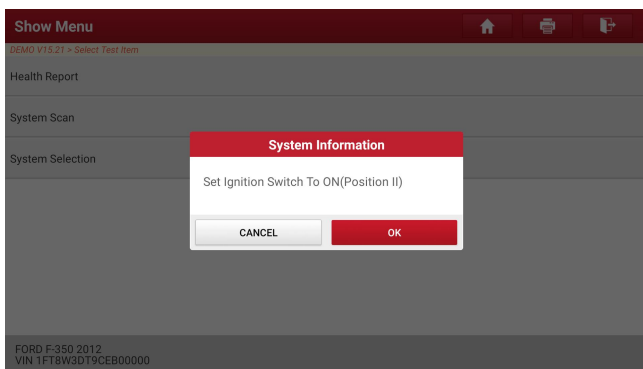

5.2.1 Health Report (Quick Test)

This function varies from vehicle to vehicle. It enables you to quickly access all the electronic control units of the vehicle and generate a detailed report about vehicle health.

On the test item selection screen, tap **Health Report** and turn on the ignition switch, the system will start scanning the ECUs. Once the scanning process is complete, the following screen will appear:

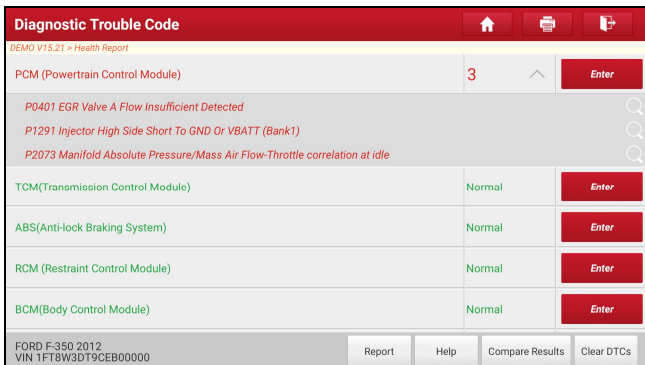

The tested system with fault code appears in red and the system with OK displays in black (normally).

Note: Diagnostic Trouble Codes or Fault Codes can be used to identify which engine systems or components that are malfunctioning. Never replace a part based only on the DTC definition. Retrieving and using DTCs for troubleshooting vehicle operation is only one part of an overall diagnostic strategy. Follow testing procedures (in vehicle's service manual), instructions and flowcharts to confirm the locations of the problem.

On-screen Buttons:

Enter: Tap to enter the diagnostic function selection screen.

(Search): Highlight certain diagnostic trouble code and tap it to retrieve it in the search engine.

Report: Tap to save the diagnostic result as a health report.

Report Information

Report Type

Pre-Repair ▼

Vehicle Information

FORD	F-350 ✕
2012 ✕	35565 km ✕
1FT8W3DT9CEB00000	License #:

Report Info

FORD_1FT8W3DT9CEB00000_AllSystemDTC_20200514154114 ✕

Notes:

SKIP OK

Note: Diagnostic report is classified into three categories: Pre-Repair report, Post-Repair report and Diagnostic Scan. No matter which type you saved the report as, the report type will be appended as a tag on the upper right corner of the diagnostic report for easier identification.

Tap ▼ to select the report type from the option list and input the required information, and then tap **OK**.

Note: To facilitate the comparison of the pre-repair and post-repair reports and get accurate test result, please make sure you saved the right type of the diagnostic report.

To save the report as a common diagnostic report, select **Diagnostic Scan**.

More Information	
Shop Name Launch HQ	Telephone 18123979575
Address line1 Long gang District	Email 764080333@qq.com
Address line2	Technician Name Add
City shenzhen	Customer Name Customer Name
State Guangdong Province	Zip Code 518129
	Country Afghanistan
SKIP	OK

Note: For workshop information, tap the input box to enter it. Alternatively you can also set it in **Profile -> Settings -> Shop Information**.

Once you configured the information, it will be automatically generated every time you saved the diagnostic report. All vehicle and workshop information will be appended as tags on the diagnostic report.

To ignore the workshop information, tap **Skip** to go to the report details screen.

Report	
<div style="text-align: right;">    </div>	
Vehicle Diagnostic Report The Report is created by LAUNCH X431	
Repair Shop	
Shop Name: Launch HQ Address: Long gang District shenzhen Guangdong Province Zip Code: 518129 Telephone: 18123979575 Email: 764080333@qq.com Fax: fax SN: 989340000112 Test Time: 2020-05-14 15:50:03	
	
FORD F-350 2012 VIN 1FT8W3DT9CEB00000	
Share Save	

On the report details screen, tap **Save** to save it. All diagnostic reports are saved in **User Info -> My Report -> Health Report**.

Help: Tap to view the help information of the selected DTC item.

Compare Results: Tap to select the pre-repair report to compare. By

comparison of the pre- and post- repair reports, you can easily identify which DTCs are cleared and which remain unfixed.

Compare Results		
DEMO V15.21 > Health Report		
DTC	Post	Pre
PCM (Powertrain Control Module)		
P0401 EGR Valve A Flow Insufficient Detected	Cleared	Found
P1291 Injector High Side Short To GND Or VBATT (Bank1)	Cleared	Found
P2073 Manifold Absolute Pressure/Mass Air Flow-Throttle correlation at idle	Cleared	Found

- **Post** indicates DTC status of post-repair.
- **Pre** indicates DTC status of pre-repair.

Note: Before performing this function, please make sure that:

- You have saved a pre-repair report of the currently tested vehicle, and
- You have already made some repairs and service and cleared the DTCs after the pre-repair reported is generated. Otherwise, no differences exist between the pre- and post- repair reports.

Clear DTCs: Tap to clear the existing diagnostic trouble codes.

Note: Clearing DTCs does not fix the problem(s) that caused the code(s) to be set. If proper repairs to correct the problem that caused the code(s) to be set are not made, the code(s) will appear again and the check engine light will illuminate as soon as the problem that cause the DTC to set manifests itself.

5.2.2 System Scan

This option allows you to quickly scan which systems are installed on the vehicle.

On the test item selection screen, tap **System Scan**, the system start scanning the systems. Once the scanning process is complete, the following screen will appear.

Select Test Item	
DEMO V15.21 > System Scan	
System Name	Result
PCM (Powertrain Control Module)	Equipped
TCM(Transmission Control Module)	Equipped
ABS(Anti-lock Braking System)	Equipped
RCM (Restraint Control Module)	Equipped
BCM(Body Control Module)	Equipped
IMMO(Immobilizer)	Equipped
APIM (Accessory Protocol Interface Module)	Equipped
PAM (Parking Assist Module)	Equipped
FORD F-350 2012 VIN 1FT8W3DT9CEB00000	

Tap the desired system to go to the diagnostic function selection screen. For detailed operations on diagnostic function, please refer to Chapter 5.2.3.

5.2.3 System Selection

This option allows you to manually select the test system and function step by step.

On the test item selection screen, tap **System Selection**, the screen displays as follows:

Show Menu	
DEMO V15.21 > System Selection	
PCM (Powertrain Control Module)	TCM(Transmission Control Module)
ABS(Anti-lock Braking System)	RCM (Restraint Control Module)
BCM(Body Control Module)	IMMO(Immobilizer)
APIM (Accessory Protocol Interface Module)	PAM (Parking Assist Module)
ICM1 (Information Center Module)	DDM (Driver Door Module)
DSM (Driver Seat Module)	DSP (Digital Signal Processor)
IPC (Instrument Panel Control Module)	FCIM (Front Controls Interface Module)
FORD F-350 2012 VIN 1FT8W3DT9CEB00000	

Swipe the screen from the bottom to view the vehicle system on the next page.

Tap the target system (take **ECM** for example) to navigate to the diagnostic function selection screen.

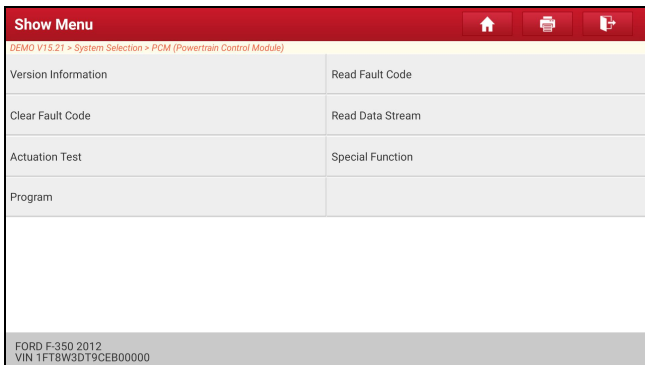

Note: Different vehicle has different diagnostic menus.

A. Version Information

This function is used to read the version information of system mode, vehicle VIN, software and ECU.

B. Read Fault Code

This function displays the detailed information of DTC records retrieved from the vehicle's control system.

Note: Retrieving and using DTCs for troubleshooting vehicle operation is only one part of an overall diagnostic strategy. Never replace a part based only on the DTC definition. Each DTC has a set of testing procedures, instructions and flow charts that must be followed to confirm the location of the problem. This information can be found in the vehicle's service manual.

On the diagnostic function selection screen, tap **Read Fault Code**, the screen will display the diagnostic result.

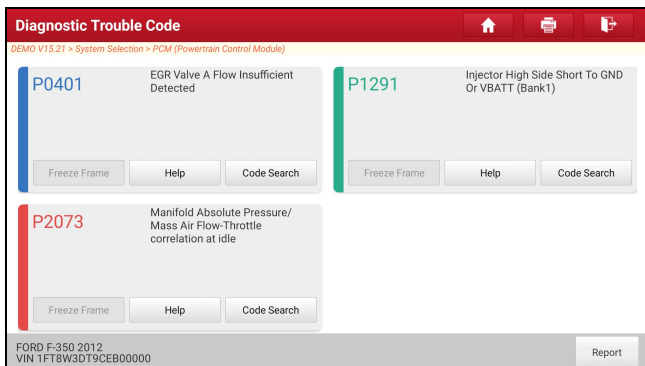

On-screen Buttons:

Freeze Frame: When an emission-related fault occurs, certain vehicle conditions are recorded by the on-board computer. This information is referred to as freeze frame data. Freeze frame data includes a snapshot of critical parameter values at the time the DTC is set.

Help: Tap to view the help information.

Code Search: Tap to search for more information about the current DTC online.

Report: Tap to save the current data in text format. All reports are saved in **Profile -> My Report -> Health Reports**. For details on report operations, please refer to Chapter 9.1 **My Report**.

C. Clear Fault Code

This function enables you to erase the codes from the vehicle after reading the retrieved codes from the vehicle and certain repairs have been carried out. Before performing this function, make sure the vehicle's ignition key is in the ON position with the engine off.

Clearing DTCs does not fix the problem(s) that caused the code(s) to be set. If proper repairs to correct the problem that caused the code(s) to be set are not made, the code(s) will appear again and the check engine light will illuminate as soon as the problem that cause the DTC to set manifests itself.

On the diagnostic function selection screen, tap **Clear Fault Code**, the following screen will appear.

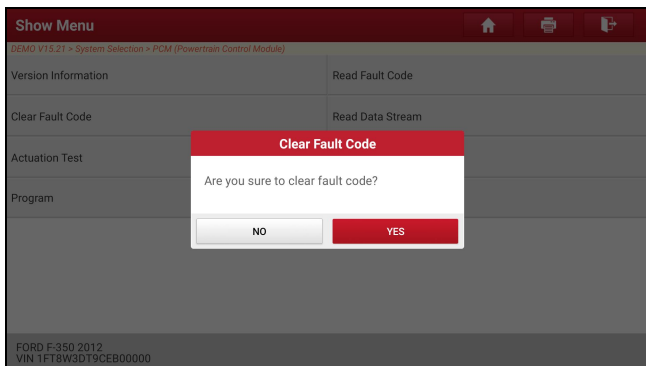

Tap **YES**, the system will automatically delete the currently existing trouble code.

Note: After clearing, you should retrieve trouble codes once more or turn ignition on and retrieve codes again. If there are still some trouble codes in the system, please troubleshoot the code using a factory diagnosis guide, then clear the code and recheck.

D. Read Data Stream

This option lets you view and capture (record) real-time Live Data. This data including current operating status for parameters and/or sensor information can provide insight on overall vehicle performance. It can also be used to guide vehicle repair.

Notes:

- If you must drive the vehicle in order to perform a troubleshooting procedure, ALWAYS have a second person help you. Trying to drive and operate the diagnostic tool at the same time is dangerous, and could cause a serious traffic accident.
- The real time (Live Data) vehicle operating information (values/status) that the on-board computer supplies to the tool for each sensor, actuator, switch, etc. is called Parameter Identification Data (PID).

On the diagnostic function selection screen, tap **Read Data Stream**, the following screen will appear.

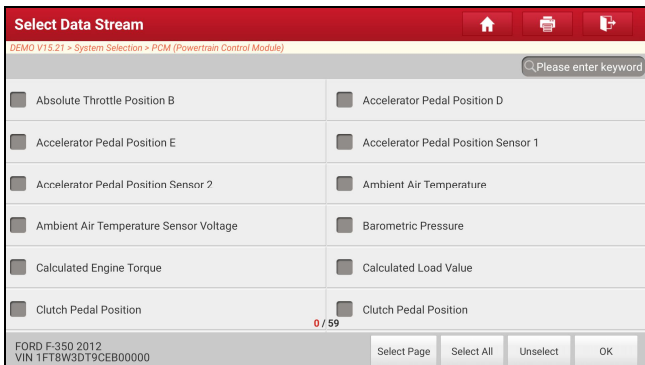

On-screen Buttons:

Select Page: Tap to select all items of the current page.

Select All: Tap to select all items. To select certain data stream item, just check the box before the item name.

Unselect: Tap to deselect all data stream items.

OK: Tap to confirm and jump to the next step.

After selecting the desired items, tap **OK** to enter the data stream reading page.

Name	Value	Standard Range	English	Metric
Absolute Throttle Position B	14.12	0 - 100	%	
Accelerator Pedal Position D	7.06	0 - 100	%	
Accelerator Pedal Position E	24.71	0 - 100	%	
Accelerator Pedal Position Sensor 1	1.04	0 - 5	V	
Accelerator Pedal Position Sensor 2	0.53	0 - 5	V	
Ambient Air Temperature	21	-40 - 215	degree C	

FORD F-350 2012
VIN 1FT8W3D19CEB00000

Compare Sample Save Sample Graph Report Record Help

Notes:

1. If the value of the data stream item is out of the range of the standard (reference) value, the whole line will display in red. If it complies with the reference value, it

displays in blue (normal mode).

- The indicator 1/X shown on the bottom of the screen stands for the current page/total page number. Swipe the screen from the right/left to advance/return to the next/previous page.

There are 3 types of display modes available for data viewing, allowing you to view various types of parameters in the most suitable way.

- ✓ **Value** – This is the default mode which displays the parameters in texts and shows in list format.
- ✓ **Graph** – Displays the parameters in waveform graphs.
- ✓ **Combine** – This option is mostly used in graph merge status for data comparison. In this case, different items are marked in different colors.

On-screen Buttons:



Graph(Single): Tap to view the parameter in waveform graph.



- **Min/Max:** Tap to define the maximum / minimum value. Once the value goes beyond the specified value, the system will alarm.

Graph: Tap to view the parameters in waveform graphs.

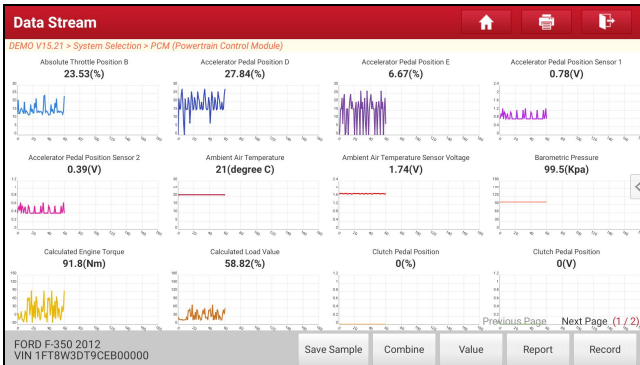

- Combine:** This option is mostly used in graph merge status for data comparison. In this case, different items are marked in different colors (maximum 4 items can be displayed on the same screen simultaneously). If the graph is more than one page, swipe the screen from the left to jump to the next page.

Data Stream		Maximum 4 data streams can be selected.
DEMO V15.21 > System Selection > PCM (Powertrain Control Module)		
Name	Value	<input type="checkbox"/> Absolute Throttle Position B
		<input type="checkbox"/> Accelerator Pedal Position D
		<input type="checkbox"/> Accelerator Pedal Position E
		<input type="checkbox"/> Accelerator Pedal Position Sensor 1
		<input type="checkbox"/> Accelerator Pedal Position Sensor 2
		<input type="checkbox"/> Ambient Air Temperature
		<input type="checkbox"/> Ambient Air Temperature Sensor Voltage
		<input type="checkbox"/> Barometric Pressure
FORD F-350 2012 VIN 1FT8W3DT9CEB00000		

- Value:** Switches the current graph display mode to the Value display mode.
- Customize:** Tap , a pull-down list of the data stream items appears on the screen. Select / deselect the desired items, and then screen will display / remove the waveforms corresponding to these items immediately.



Compare Sample: Tap to select the sample DS file.

The screenshot shows the 'Data Stream' table with a 'Compare Sample' dialog box overlaid on the 'Accelerator Pedal Position Sensor' row. The table columns are Name, Value, Standard Range, English, and Metric. The dialog box contains the following text:

Please choose sample data stream record
 DEMO_Save Sample_20200514155503
 Demo/F-350/2012/PCM (Powertrain Control Module)
 2020-05-14 15:57:03

Name	Value	Standard Range	English	Metric
Absolute Throttle Position B	12.55	0 - 100	%	
Accelerator Pedal Position D	15.69	0 - 100	%	
Accelerator Pedal Position E			%	
Accelerator Pedal Position Sensor			V	
Accelerator Pedal Position Sensor 2	0.4	0 - 5	V	
Ambient Air Temperature	21 (1 / 2)	-40 - 215	degree C	

Buttons at the bottom: Compare Sample, Save Sample, Graph, Report, Record, Help.

All the values you customized and saved in process of DS sampling will be imported into the **Standard Range** (See below) column for your comparison.

Note: Before executing this function, you have to sample the values of data stream items and save it as a sample Data Stream file.

Data Stream						
JEMO V15.21 > System Selection > PCM (Powertrain Control Module)						
Name	Value	Standard Range(Data Stream Sample)	English	Metric		
Absolute Throttle Position B	21.96	12.55 - 15	%			
Accelerator Pedal Position D	15.69	0 - 13.6	%			
Accelerator Pedal Position E	15.69	0 - 20.4	%			
Accelerator Pedal Position Sensor 1	0.78	0.78 - 1.08	V			
Accelerator Pedal Position Sensor 2	0.4	0.39 - 0.48	V			
Ambient Air Temperature	21 (1 / 2)	21 - 21	degree C			
FORD F-350 2012 VIN 1FT8W3D19CEB00000						
Compare Sample		Save Sample	Graph	Report	Record	Help

Report: Tap to save the current data in text format. All reports are saved in **Profile -> My Report -> Health Reports**. For details on report operations, please refer to Chapter 9.1.

Record: Tap to start recording diagnostic data. Recorded live data can serve as valuable information to help you in troubleshooting of vehicle problems.

Data Stream						
JEMO V15.21 > System Selection > PCM (Powertrain Control Module)						
Name	Value	Standard Range	English	Metric		
Absolute Throttle Position B	14.51	0 - 100	%			
Accelerator Pedal Position D	20.78	0 - 100	%			
Accelerator Pedal Position E	0	0 - 100	%			
Accelerator Pedal Position Sensor 1	0.78	0 - 5	V			
Accelerator Pedal Position Sensor 2	0.4	0 - 5	V			
Ambient Air Temperature	21 (1 / 2)	-40 ~ 215	degree C	Recording 00:12		
FORD F-350 2012 VIN 1FT8W3D19CEB00000						
Compare Sample		Save Sample	Graph	Report	Record	Help

Tap to end recording and save it. The saved file follows the naming rule: It begins with vehicle type, and then the product S/N and ends with record starting time (To differentiate between files, please configure the accurate system time).

All diagnostic records can be replayed from **Profile -> My Report -> Recorded Data**.

Save Sample: This item enables you to customize the standard range of live

data stream items and save it as DS sample file. Each time you run the data stream items, you can call out the corresponding sample data to overwrite the current standard range.

Tap it to start recording the sample data (Note: Only data stream items with measurement units will be recorded), the following screen will appear:

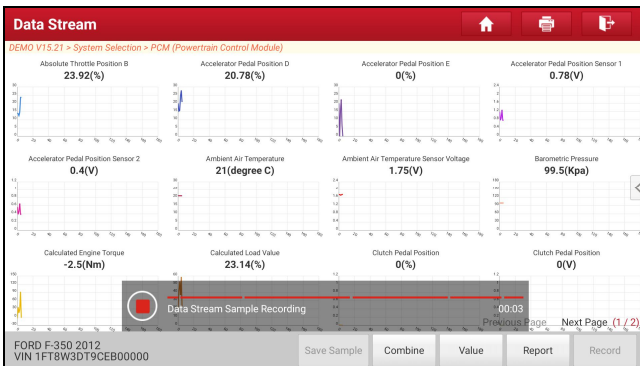

Once the recording process is complete, tap  to stop it and navigate to the data revision screen.

The screenshot shows the 'Confirm Sample DS' screen with the following table:

Name	Min Value	Max Value	Unit
Absolute Throttle Position B	12.55	23.92	%
Accelerator Pedal Position D	0.0	27.84	%
Accelerator Pedal Position E	0.0	26.67	%
Accelerator Pedal Position Sensor 1	0.78	1.28	V
Accelerator Pedal Position Sensor 2	0.39	0.65	V
Ambient Air Temperature	21.0	21.0	degree C

At the bottom, the vehicle information 'FORD F-350 2012 VIN 1FT8W3DT9CEB00000' is displayed, along with a 'Save' button.

Tap the Min./Max. value to change it. After modifying all desired items, tap **Save** to save it as a sample DS file. All DS files are stored in **Profile -> Data Stream Sample**.

E. Actuation Test

This option is used to access vehicle-specific subsystem and component tests. Available test vary by vehicle manufacturer, year, and model.

During the actuation test, the display tablet outputs commands to the ECU in order to drive the actuators, and then determines the integrity of the system or parts by reading the ECU data, or by monitoring the operation of the actuators, such as switching a injector between two operating states.

On the diagnostic function selection screen, tap **Actuation Test**, the system will display as follows:

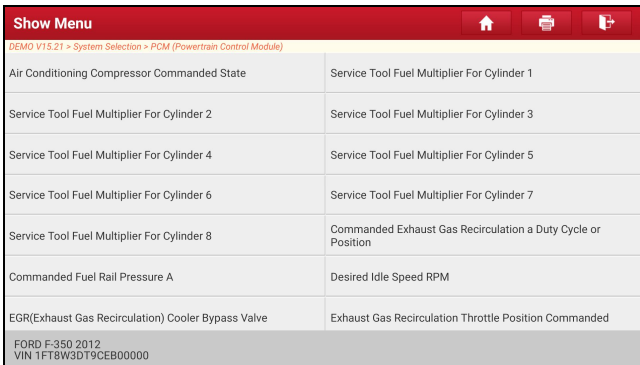

Simply follow the on-screen instructions and make appropriate selections to complete the test.

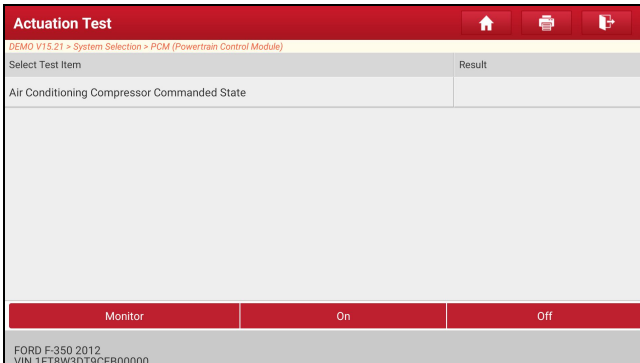

Each time when an operation is successfully executed, *Completed* displays.

F. Special Function

In addition to amazing & powerful diagnostic function, the tool also features various reset functions, which varies from vehicle to vehicle.

5.3 Tech 2 Tech

This option aims to help repair shops or technicians launch instant messaging and remote diagnosis, making the repair job getting fixed faster.

Tap **Tech 2 Tech** on the Job menu, a disclaimer page will pop up on the screen:

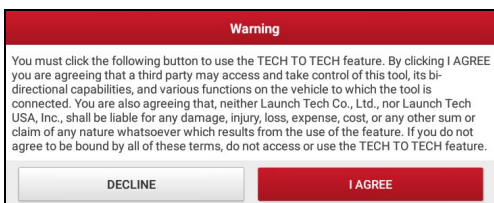

Tap **I AGREE** to enter the Contact page. The screen appears blank by default.

5.3.1 Interface Layout

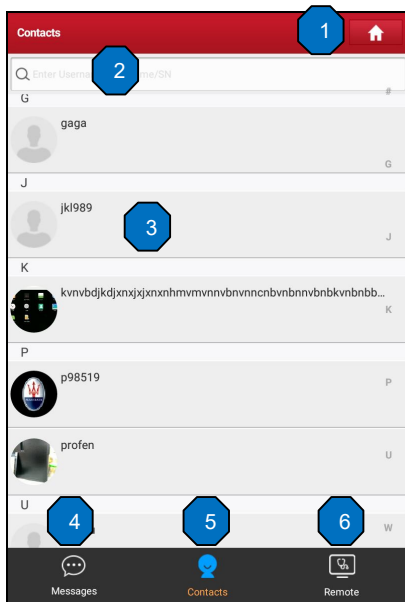

1	Home button	Tap it to navigate to the Job menu screen.
2	Search bar	Directly input the registered username of the tool to start searching, and then tap the desired one to add it into your friend list.
3	Friend list display area	By default it appears blank.
4	Message tab	Once an incoming message reaches, a red dot will appear on the upper right corner of the tab.
5	Contact tab	Tap to enter the friend list.
6	Remote switch	Tap to slide the switch to ON, the tool keeps online and becomes accessible on the web client. In this case, inform the technician of your product S/N, and

	he/she will control your device remotely.
--	---

5.3.2 Add Friends

Tap **Contact** to enter the contact page. By default it appears blank.

In the search bar, input the partner's username and tap **Search** button next to the search bar to starts searching from Launch's golo business database.

The partner must be the users who have registered their Launch's diagnostic tools. They may be the following:

- Workshop
- Technician
- golo users

Once the result matches the keyword, a screen similar to the following will appear:

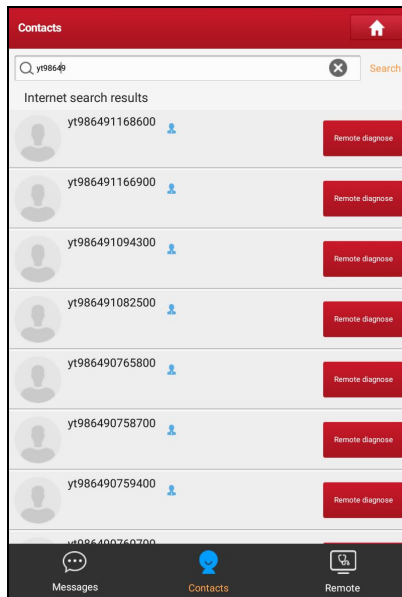

Here you can tap **Remote Diagnose** to launch remote diagnostics directly or

choose to add the partner into the Contacts list.

Tap the desired name from the list, an option list will appear on the screen. Tap **Add friend**, a dialog box pops up:

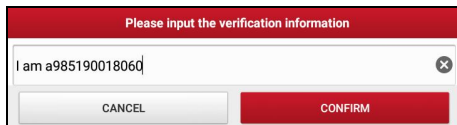

Tap **CONFIRM** to send your request.

Once the partner receives the request, a beep will sound. Tap the **Message** tab:

- Once the partner agreed your request, he/she will automatically be listed in the Contact tab.
- If a technician sent you a friend request, tap **Agree** to confirm and his/her name will appear in the friend list (Contact). Or tap **Ignore** to ignore this request.

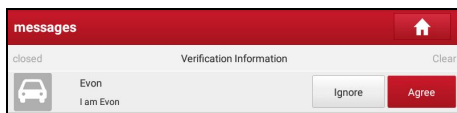

5.3.3 Start Instant Messaging

Note: The I/M (Instant Messaging) function is open to all users who had Launch's diagnostic tool equipped with this module.

After adding your friends, tap the desired one's photo to enter a screen similar to the following:

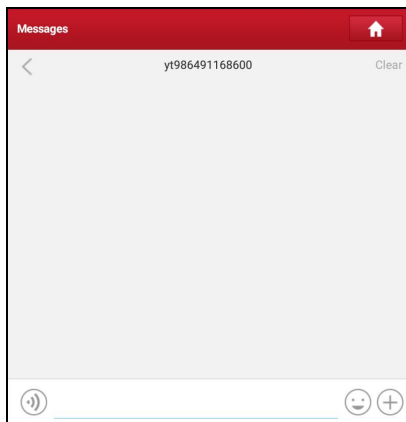

Tap the input field and use the on-screen keyboard to enter the text message, and then tap **Send** to send it.

Tap  to send the voice message.

Tap  to send the emoji.

Tap  to call out more function options.

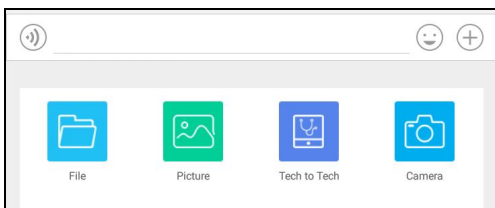

- **File**: Choose diagnostic reports or local files to send.
- **Picture**: Choose screenshots or pictures to send.
- **Tech to Tech**: To start a remote diagnostic session. For details, refer to Chapter 5.3.4.
- **Camera**: Open camera to take pictures.

Tap **Clear** to delete all the partner's dialog logs.

Tap **Close** to close the current dialog.

5.3.4 Launch Remote Diagnosis (Device-To-Device)

The display tablet is allowed to launch remote diagnosis with other diagnostic tools (including but not limited to the X-431 Torque series) of Launch family, which are equipped with this module.

Note: Before performing this operation, please make sure the following no matter which side sends the remote request:

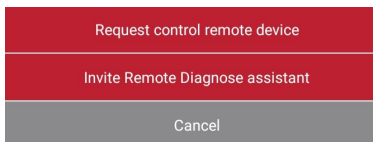

- Turn on the vehicle power supply.
- Throttle should be in a closed position.
- The tablet should be properly connected to the vehicle's DLC and a successful communication is required.

On the function option selection screen, tap **Tech to Tech**, a pull-down menu including the following options appears:

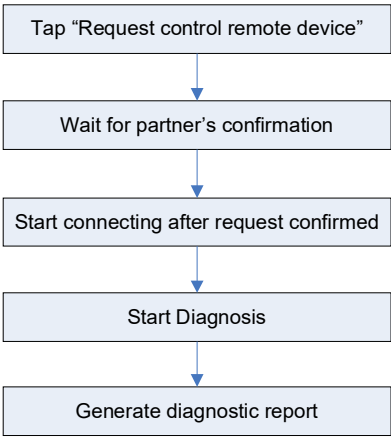

These options are defined as follows:

Actions	Results
Request control remote device	Request to control the partner's device remotely to help him diagnose the vehicle. Notes: <ul style="list-style-type: none"> • Remote diagnosis has the same diagnostic steps as manual diagnosis. • In process of remote diagnosis, tap the  button to send a voice message. • Once vehicle diagnosis is complete, a report will be created. Input your comments on this report, and then tap Send Report to send it to the partner.

	 <pre> graph TD A[Tap "Request control remote device"] --> B[Wait for partner's confirmation] B --> C[Start connecting after request confirmed] C --> D[Start Diagnosis] D --> E[Generate diagnostic report] </pre>
<p>Invite remote diagnostic assistant</p>	<p>If you need support, just use this option to invite a technician to perform a remote control on your tool.</p> <p>Notes:</p> <ul style="list-style-type: none"> • Remote diagnosis has the same diagnostic steps as manual diagnosis. • In process of remote diagnosis, tap the  button to send voice message. • Once you received the report from the partner, tap View Report to view details. All diagnostic reports are saved in Profile -> My Reports -> Remote Reports.

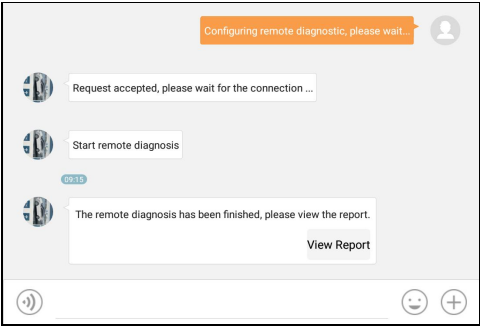
	 <p>Configuring remote diagnostic, please wait...</p> <p>Request accepted, please wait for the connection ...</p> <p>Start remote diagnosis</p> <p>The remote diagnosis has been finished, please view the report.</p> <p>View Report</p> <pre>graph TD; A[Tap "Invite remote diagnostic assistant"] --> B[Choose the desired diagnostic software]; B --> C[Wait for partner's confirmation]; C --> D[Start connecting after request confirmed]; D --> E[Start Diagnosis]; E --> F[Generate diagnostic report];</pre>
Cancel	To cancel this operation.

5.3.5 Launch Remote Diagnosis (Device-To-PC)

Except that the remote diagnosis can be done between different Launch's diagnostic tools that come loaded with the module, user also can ask for remote control from PC client technician.

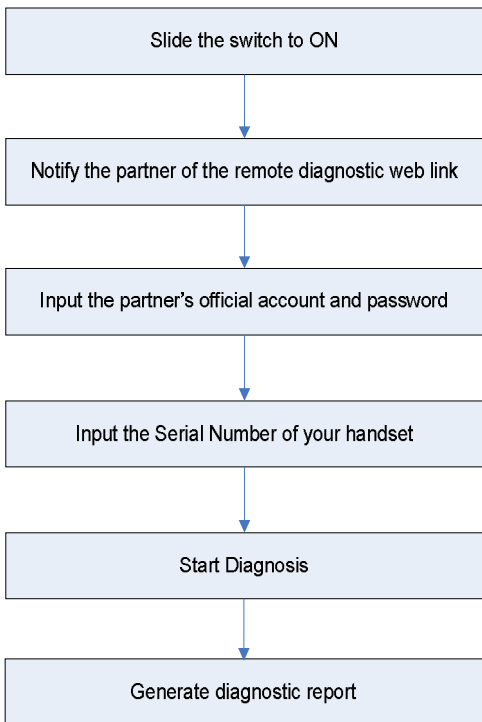

Tap the **Web Remote** tab, the screen displays as follows:

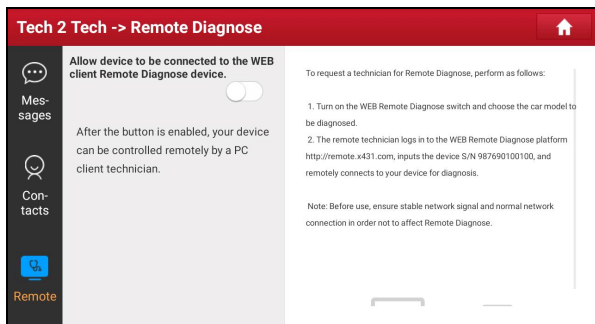

1. Slide the switch *Allow device to be connected to the WEB client remote diagnostic device* to ON so that the partner can find and connect to this device while using the PC.
2. Notify the partner of the PC client website <http://remote.x431.com/cn/>. When the partner accesses the link, the PC displays as below:

Note: Before processing remote diagnosis, please make sure the display tablet is properly connected to the vehicle.

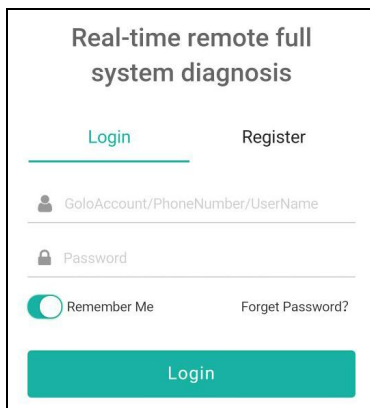

3. Tell the partner to input his own official technician account and password, and then tap **Login** to navigate to the following figure.

Remote diagnosis

Serial Number
Locate the car to be diagnosed according to golo/AIT serial number

License Plate Number
Locate the car to be diagnosed according to the car owner's license plate number

Phone Number
Locate the car to be diagnosed according to the car owner's phone number

972290000223

Start remote diagnosis

Tips: Before starting remote diagnosis, confirm the car owner's car information and condition

4. Tell the partner to check the box *Series number* and enter the Serial Number provided by you, and then tap **Start remote diagnosis** to control your device remotely.

In process of remote diagnosis, please note the following things:

- 1) You are not suggested to execute any actions.
- 2) The partner is not allowed to save any diagnostic reports or records on your tool.

The operations in remote diagnosis are same as those in local diagnosis. Once the session is complete, a remote diagnostic report will be automatically generated.

5.4 Diagnostic History

Generally once a vehicle diagnosis is performed, the tablet will record the every details of diagnostic process. The History function provides direct access to the previously tested vehicles and users can resume from the last operation, without starting from scratch.

Tap **History** on the Diagnose main menu screen, all diagnostic records will be listed on the screen in date sequence.

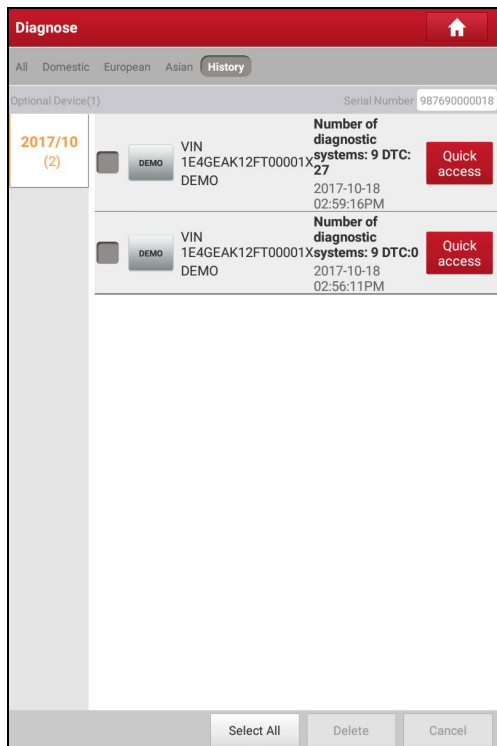

- Tap certain vehicle model to view the details of the last diagnostic report.
- To delete certain diagnostic history, select it and then tap **Delete**. To delete all historical records, tap **Select All** and then tap **Delete**.
- Tap **Quick access** to directly navigate to the function selection page of last diagnostic operation. Choose the desired option to proceed.

6 Diagnostic Feedback

This item allows you to feedback your diagnostic problems to us for analysis and troubleshooting.

Tap “Feedback”, a pop-up message will appear:

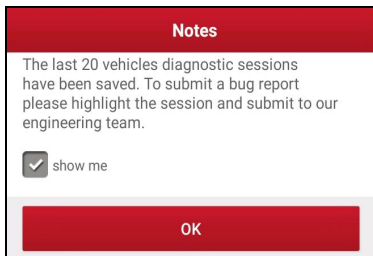

Tap “Confirm”, the following 3 options will be displayed on the left column of the screen.

A. Feedback

Tap certain tested vehicle model to enter the feedback screen.

- 1) Tap “Choose File” to open the target folder and choose the desired diagnostic logs.
- 2) Choose the failure type and fill in the detailed failure description in the blank text box and telephone or email address. After inputting, tap “Submit Result” to send it to us.

B. History

Tap it to view all diagnostic feedback records. Different process states are marked with different colors.

C. Offline list

Tap it to display all diagnostic feedback logs which have not been submitted successfully due to network failure. Once the handset gets a stable network signal, it will be uploaded to the remote server automatically.

7 I/M Readiness

An important part of a vehicle's OBD II system is the Readiness Monitors, which are indicators used to find out if all of the emissions components have been evaluated by the OBD II system. They are running periodic tests on specific systems and components to ensure that they are performing within allowable limits.

Currently, there are eleven OBD II Readiness Monitors (or I/M Monitors) defined by the U.S. Environmental Protection Agency (EPA). Not all monitors are supported in every vehicles and the exact number of monitors in any vehicle depends on the motor vehicle manufacturer's emissions control strategy.

Continuous Monitors -- Some of the vehicle components or systems are continuously tested by the vehicle's OBD II system, while others are tested only under specific vehicle operating conditions. The continuously monitored components listed below are always ready:

- 1) Misfire
- 2) Fuel System
- 3) Comprehensive Components (CCM)

Once the vehicle is running, the OBD II system is continuously checking the above components, monitoring key engine sensors, watching for engine misfire, and monitoring fuel demands.

Non-Continuous Monitors -- Unlike the continuous monitors, many emissions and engine system components require the vehicle to be operated under specific conditions before the monitor is ready. These monitors are termed non-continuous monitors and are listed below:

- 1) EGR System
- 2) O2 Sensors
- 3) Catalyst
- 4) Evaporative System
- 5) O2 Sensor Heater
- 6) Secondary air Injection
- 7) Heated Catalyst
- 8) A/C system

I/M refers to Inspection and Maintenance that is legislated by the Government to meet federal clean-air standards. I/M Readiness indicates whether or not the various emissions-related systems on the vehicle are operating properly and are ready for Inspection and Maintenance testing.

The purpose of the I/M Readiness Monitor Status is to indicate which of the vehicle's Monitors have run and completed their diagnosis and testing, and which ones have not yet run and completed testing and diagnosis of their designated sections of the vehicle's emissions system.

The I/M Readiness Monitor Status function also can be used (after repair of a fault has been performed) to confirm that the repair has been performed correctly, and/or to check for Monitor Run Status.

Tap **I/M Readiness** on the Job Menu, a screen similar to the following appears:

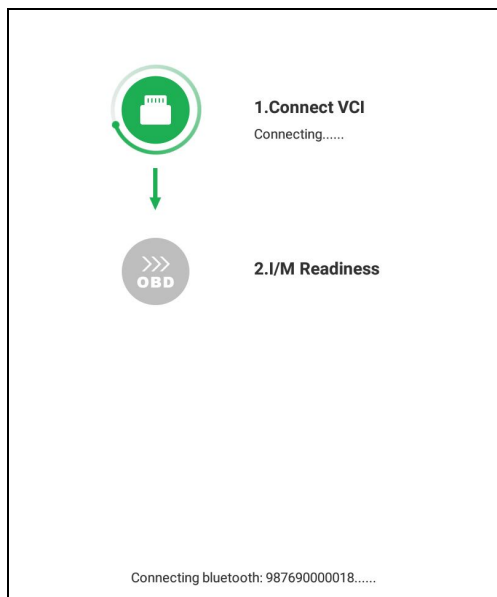













After checking all I/M readiness status, the screen will output the result:



I/M Readiness



VIN : WP1AG2928DLA54391 

Year : 2016 Make: Porsche
 Model: Ip700 Date : 07/23/2017 12: 28: 05

3   **CAN-15765-4**
 DTCs MIL Voltage Agreement

Monitor	Value
Misfire	
Fuel System	
Comprehensive Component	
Catalyst	
Heated Catalyst	
Evaporative System	
Secondary Air injection	
O2 sensor	
O2 sensor heater	
EGR	

 Completed  Uncompleted  Unsupported

Note:  means not available on this vehicle,  means incomplete or not ready,  means Completed or Monitor Ok.

7 Software Update

This module allows you to update the diagnostic software & App and set frequently used software.

If you did not download the software in process of product registration or a pop-up message prompting you that some new software can be updated, you may use this option to download it or keep it synchronized with the latest version.

7.1 Update Diagnostic Software & APP

By default, the system enters the **All Software** screen and all diagnostic software to be updated is selected.

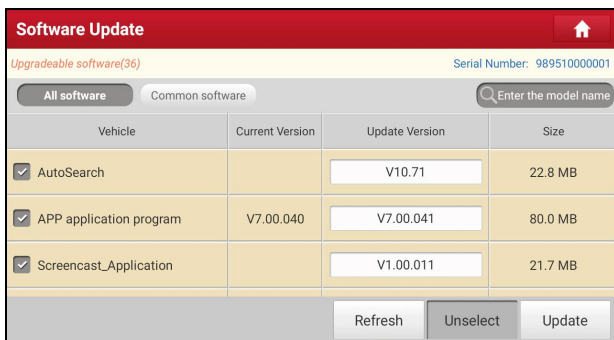

- To deselect certain software, tap **Unselect**, and then check the box next to vehicle model.
- To refresh the downloaded list, tap **Refresh**.
- Tap **Update** to start downloading and installing.

Note: Download and installation may take approximate 10 minutes depending on the internet connection, please be patient to wait.

To pause downloading, tap **Stop**. To resume it, tap **Continue**. If network connection failure occurs, tap **Retry** to try again.

Once download is finished, the software packages will be installed automatically.

7.2 Set Frequently Used software

To easily locate and quickly update some frequently used software, you can use the Common Software option to create a frequently used software list.

Tap **Common software**, the screen displays as follows:

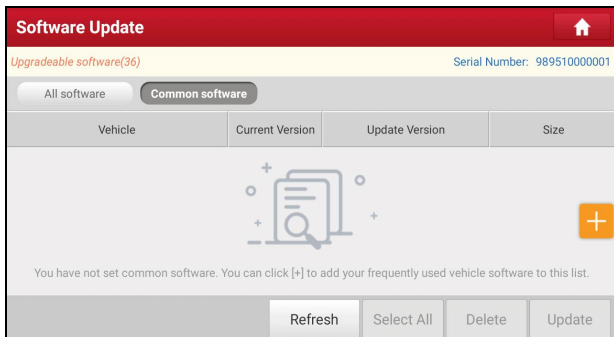

Tap , a pop-up window appears.

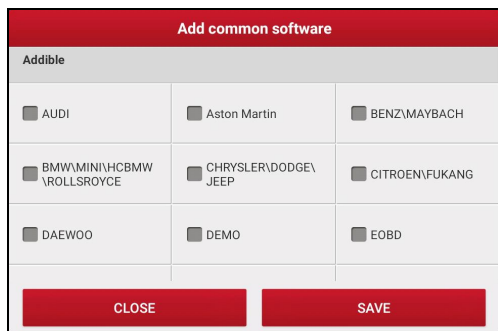

Select the checkbox before the software name and tap **SAVE**, the software will be displayed in the Common software list. Next time you want to update it, just go to **Common Software**.

7.3 Renew software subscription

If the software subscription is due or expires, the system will prompt you to

renew your subscription and a **Renewal** button will appear on the bottom of the update page.

There are 2 ways available for you to make payment: PayPal and Subscription Renewal Card (*need to buy it from the local dealer where you purchased this tool).

A. Using PayPal

1. Tap **Renewal** on the update page to navigate to the renewal type selection screen.
2. Select **PayPal**, and then follow the on-screen instructions to finish the transaction.
3. After payment, go to update center to update the diagnostic software.

B. Using Subscription Renewal Card

1. Tap **Renewal** to navigate to the renewal type selection screen.
2. Select **Subscription Renewal Card**.
3. Input the 24-digit pin code of Subscription Renewal Card and then tap **Submit** to finish the renewal.
4. Go to update center to update the diagnostic software.

8 Profile

This function allows users to manage personal information and VCI etc.

8.1 My Report



8.1.1 Health Reports

This module stores all diagnostic reports generated in process of vehicle diagnosis.

All diagnostic reports are sorted by Date and Make. Tap the desired type to re-arrange and filter it.

- To select certain report, check the box before the report. To select all reports, tap **Select All**. To deselect all, tap **Unselect**.
- To share the report with others, select the desired one and then tap **Share**.
- Select the desired report and then tap **Delete** to delete it.
- To change the filename of report, tap **Rename**.
- To quickly locate the desired report, tap **Filter**.
- To exit the full screen, tap **Exit full screen**.

8.1.2 Remote Reports

This option lists all diagnostic reports generated in process of remote diagnostics.

8.1.3 ROXIE Reports

This option stores all vehicle inspection reports generated by the ROXIE W device that has been bound to the tool.

8.1.4 Recorded Data

If user records the running parameters or waveform graphs while reading data stream, it will be saved as diagnostic records and appear under this tab.

Tap **Recorded Data**, and select certain diagnostic record to enter.

Select the desired data stream items and tap **OK** to navigate to the playback page.

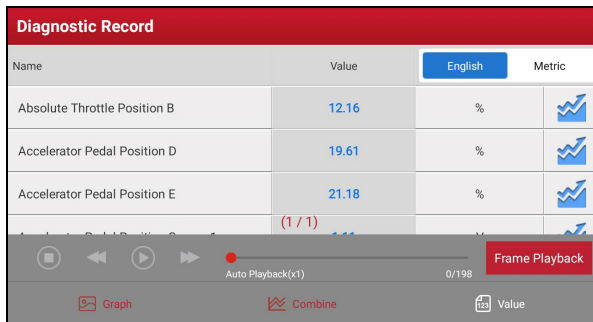

On-screen Buttons:

Graph – displays the parameters in waveform graphs.

Combine – this option is mostly used in graph merge status for data comparison. In this case, different items are marked in different colors.

Value – this is the default mode which displays the parameters in texts and shows in list format.

Frame Playback – plays back the recorded data stream items frame by frame. Once it is in frame playback mode, this button changes into **Auto Playback**.

8.2 VCI Management

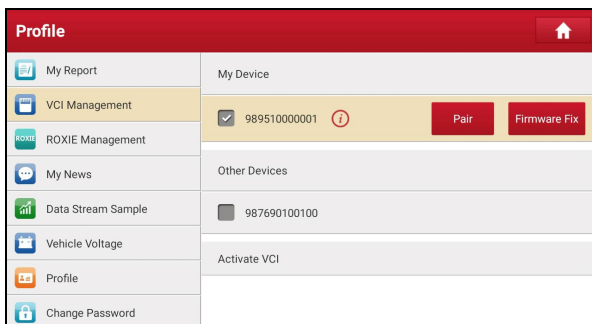

If several VCI devices are activated on this tool, a list of VCI devices will be displayed on the screen. If your tool extends to support heavy-duty trucks, you need to switch to the corresponding VCI module before diagnosing it.

Once you choose the device that belongs to other account, you have to log out, and then input the right account to continue.

- If you use another VCI to test a vehicle, select the desired checkbox and tap **Pair** to pair it with the tablet.
- If the current VCI comes across communication failure, tap **Firmware Fix** to update and fix the diagnostic firmware. During fixing, please do not cut power or switch to other interfaces.
- If you use the current account to test a vehicle with another tablet, tap **Unpair** to unpair the VCI device with the previously paired tablet.
- If you bought a new VCI device or skipped the Activate VCI step in process of sign-up, tap **Activate VCI** to activate it.

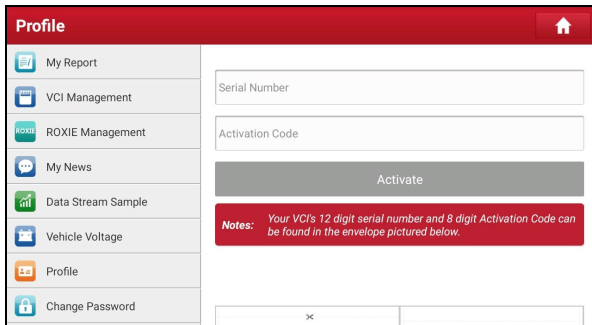

Input the Serial Number and Activation Code (can be found from the included Password Envelope), and then tap **Activate** to activate it.

Note: please be sure to keep the VCI powered on while performing the operation.

8.3 ROXIE Management

This option is used to activate and bind the ROXIE W device to the tool. Once bound, the reports generated by the ROXIE W device will be automatically pushed to the tool each time the inspection session is finished.

Tap **ROXIE Management**, a screen similar to the following figure will appear:

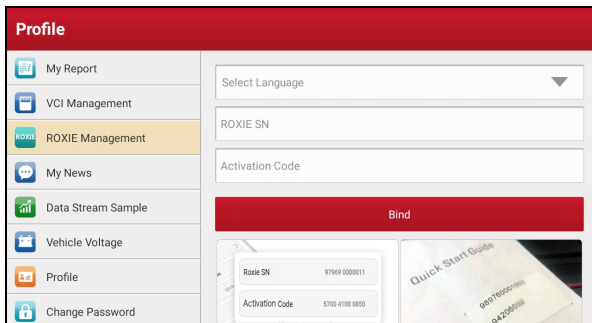

Fill in the ROXIE W S/N and Activation Code (can be found in the Settings on the Job Menu), then tap **Bind**.

8.4 My News

This option allows you to receive some commercial and promotional activity messages.

8.5 Data Stream Sample

This feature allows you to manage the recorded data stream sample files.

8.6 Vehicle Voltage

It provides you with the ability to perform a check of the vehicle's battery to ensure the system is operating within acceptable limits.

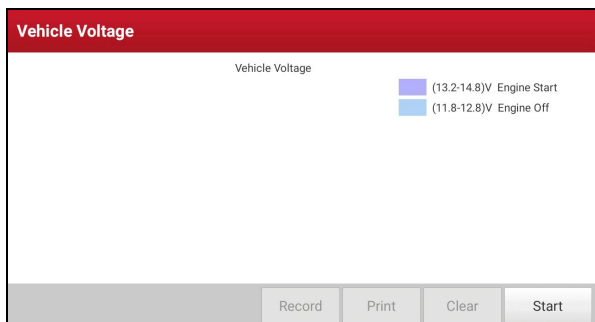

8.7 My Order

This item allows you to check the status of all your orders.

8.8 Subscription Renewal Card

This item is used to check the status of the subscription renewal card.

Input the 12-digit subscription renewal card number. Tap **Search** to get the search result.

8.9 Profile

Use this item to view and configure personal information.

8.10 Change Password

This item allows you to modify your login password.

8.11 Settings

8.11.1 General

1). Units

It is designed to set the measurement unit. Metric System and English System are available.

2). Diagnostic Software Auto Update

This option is designed to turn on/off the automatic diagnostic software update function. If set as ON, the system will automatically update the available diagnostic software when the tablet has a network connection and a newer version is detected.

3). Automatic detection once connected

This option enables you to determine whether to start an automatic VIN detection once the tablet is properly connected to the vehicle's DLC.

4). Auto Generate Health Report once connected

Once it is set as ON, the system will automatically output a health report once the AutoDetect diagnostic session is finished.

8.11.2 Shop Information

This option lets you define your print information. It mainly includes Workshop, Address, Zip Code, Telephone, Email etc.

The screenshot shows the 'Settings' app with a red header and a home button. A sidebar on the left lists various settings: General, Shop Information (highlighted), Printer Set, Orientation, Clear Cache, About, and Log Out. The main content area is titled 'Shop Information' and contains several input fields: 'Shop Name' (with a placeholder 'Shop Name' and a small image of a person working), 'Address line1', 'Address line2', 'Country' (set to 'Albania' with a right arrow), 'State / Province / Region', and 'City'.

After inputting, tap **Save**.

Once you saved the print information, it will be entered automatically in the *More Information* box every time you save the diagnostic report.

8.11.3 Printer Set

This option is designed to establish a wireless connection between the tablet and the Wi-Fi printer (sold separately) while performing printing operations.

The App is compatible with the *LAUNCH Wi-Fi Printer* (sold separately) and *System* (external printer).

For LAUNCH Wi-Fi mini printer, follow the steps below to connect the printer.

1. Tap **Printer Set**.

The screenshot shows the 'Printer Set' settings screen with a red header and a home button. The screen contains the following elements: 'Default Printer' set to 'LAUNCH System'; 'Wireless printer network settings' with a 'Reset' button and a right arrow; 'Current Wi-Fi Network:' set to 'huawei' with a right arrow; a 'Connect to the Launch printer' section with a red 'CONNECT' button; and a 'Result:' section with a grey button labeled 'PRINT TESTING RESULT'.

A. If it is the first time you have operated this printer, please proceed the

following:

1. For initial use, you are suggested to reset the printer: Press and hold [MODE] & [FEED] for 8 seconds, the following resetting command will be printed out:

at + default = 1

ok

at + reboot = 1

rebooting...

2. Tap **Reset** to configure Wi-Fi printer.

Step 1: Connect the printer:

Tap **Scan** to start scanning and select the desired printer hotspot named with X-431PRINTER-XXXX (XXXX stands for 4 characters), and then tap **Connect** to enter Step 2.

Step 2: Join the Wi-Fi printer into LAN:

Tap **Scan** to select the desired local Wi-Fi network from the list, and type in the security password (If it is an open network, password is not required), and then tap **Confirm**.

3. Once the Wi-Fi network of the printer is connected and the printer is found, tap **Printing test** to test the printing.

Now the Wi-Fi printer is ready for printing.

If the printer is not found, please reset the printer to default factory settings (refer to Step 2 for details) and check whether the current device and the printer are on the same LAN.

B. If you have configured the Wi-Fi printer to the LAN:

2. Tap **Connect to Printer**:

- a). If the local network remains as it is, tap **Test Print** directly to test the printing.

- b). If the local network changes, you have to reset the Wi-Fi printer.

For other Wi-Fi printers,

Before printing, make sure the following conditions are met:

- The Wi-Fi printer is powered on and working normally.
- The print service plug-in associated with the printer is already installed on the

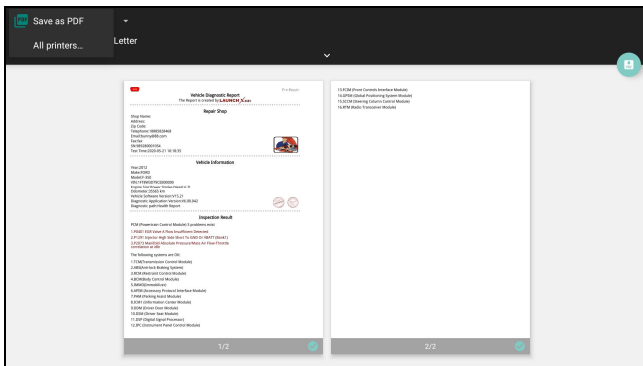

6. Select the desired Wi-Fi printer from the list. If the chosen Wi-Fi printer hotspot is open, the tablet can connect it directly. If it is encrypted, a password may be required. Refer to the Wi-Fi printer user manual to get the default password.
7. Now the printer is ready for printing.
8. Alternatively, you can also choose **Save as PDF** to save the current diagnostic report as a PDF file for later printing.

8.11.4 Orientation

The option is used to set the screen display orientation.

8.11.5 Clear Cache

This option allows you to clear the App cache. Clearing the cache will restart the App.

8.11.6 About

The software version information and disclaimer are included.

8.11.7 Login/Logout

To logout the current user ID, tap **Logout**.

To login the system again, tap **Login**.

8.12 Diagnostic Software Clear

This item allows you to hide/clear the diagnostic software that is not frequently used.

Tap **Diagnostic Software Clear** to enter.

Under the **Hide Software** tab, select the desired diagnostic software and tap **Hide**, it will become invisible. Tap **Unhide** to undo the hide operation.

Under the **Remove Software** tab, select the desired diagnostic software and tap **Delete**, it will disappear from the screen.

Note: Removing software may completely delete the software from the tablet. If some software is not used and the tablet runs out of space, please use this feature to remove it. To re-download it, go to **Update -> All Software**.

9 Synchronization

You can transfer media files, screenshots and APK between the PC and tablet.

1. Connect one end of the included charging/data cable to the charging/data I/O port of the tablet, and the other end to the USB port of the PC.
2. Swipe the tablet screen from the top, a pull-down option list will appear on the screen.

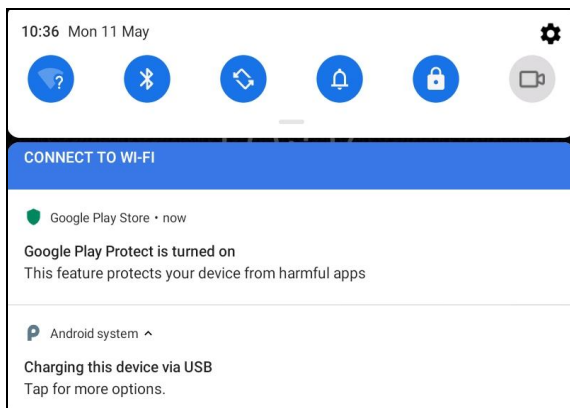

3. Tap **Charging this device via USB**, the following setting options will be displayed on the screen.

10 FAQ

1. How to save power?

- Please turn off the screen while the tool keeps idle.
- Set a shorter standby time.
- Decrease the brightness of the screen.
- If WLAN connection is not required, please turn it off.

2. Communication error with vehicle ECU?

Please confirm:

1. Whether the VCI is correctly connected.
2. Whether ignition switch is ON.
3. If all checks are normal, send vehicle year, make, model and VIN number to us using Feedback feature.

3. Failed to enter into vehicle ECU system?

Please confirm:

1. Whether the vehicle is equipped with this system.
2. Whether the VCI is correctly connected.
3. Whether ignition switch is ON.
4. If all checks are normal, send vehicle year, make, model and VIN number to us using Feedback feature.

4. How to reset the tablet?

 Resetting may cause data loss. Before doing so, please make sure important data and information has been backed up.

Do the following to reset the tablet:

1. Tap **Settings -> System -> Reset options**.
2. Tap **Erase all data (factory reset)**.
3. Tap **RESET TABLET**.
4. Tap **ERASE EVERYTHING** to start resetting until the tool automatically

reboots.

5. How to download the X-431 Torque App after resetting the tablet?

Note: Before registration, please make sure the network is properly connected.

After the tablet has been successfully reset, follow the steps below to download the App:

1. Launch the browser and the default official Launch website opens (If a blank page pops up, just type in www.x431.com in the input bar).
2. Tap **Login**, input the username and password and tap **Log In**.
3. Make sure that the serial number is correct, tap **APP application program** and tap the Download icon to start downloading.
4. After the download is complete, follow the on-screen instructions to install it.
5. After installation, use the existing username and password to login and go to update center to download the diagnostic software.

6. What to do if the language of vehicle diagnostic software does not match the system language?

English is the default system language of the tool. After the system language is set to the preference language, please go to the update center to download the vehicle diagnostic software of the corresponding language.

If the downloaded diagnostic software is still displayed in English, it indicates that the software of the current language is under development.

7. How to retrieve the login password?

Please follow below steps to proceed in case you forgot the login password:

1. Tap the application icon on the home screen to launch it.
2. Tap the **Login** button on the upper right corner of the screen.
3. Tap **Retrieve password**.
4. Input product S/N and follow the on-screen prompts to retrieve the password.

Warranty

THIS WARRANTY IS EXPRESSLY LIMITED TO PERSONS WHO PURCHASE LAUNCH PRODUCTS FOR PURPOSES OF RESALE OR USE IN THE ORDINARY COURSE OF THE BUYER'S BUSINESS.

LAUNCH electronic product is warranted against defects in materials and workmanship for one year from date of delivery to the user.

This warranty does not cover any part that has been abused, altered, used for a purpose other than for which it was intended, or used in a manner inconsistent with instructions regarding use. The exclusive remedy for any automotive meter found to be defective is repair or replacement, and LAUNCH shall not be liable for any consequential or incidental damages.

Final determination of defects shall be made by LAUNCH in accordance with procedures established by LAUNCH. No agent, employee, or representative of LAUNCH has any authority to bind LAUNCH to any affirmation, representation, or warranty concerning LAUNCH automotive meters, except as stated herein.

Disclaimer

The above warranty is in lieu of any other warranty, expressed or implied, including any warranty of merchantability or fitness for a particular purpose.

Purchase Order

Replaceable and optional parts can be ordered directly from your LAUNCH authorized tool supplier. Your order should include the following information:

- Order quantity
- Part number
- Part name

Customer Service

If you have any questions or comments please forward them to:

LAUNCH Tech USA

Product Support

Phone: 877-528-6249 xt: 4

E-mail: support@launchtechusa.com

Fax: 562-463-1590

Monday - Friday 5 am - 5 pm PST

Service & Repair

Phone: 877-528-6249 xt: 5

Monday - Friday 8 am - 5 pm PST

If your unit requires repair service, return it to the manufacturer with a copy of the sales receipt and a note describing the problem. If the unit is determined to be in warranty, it will be repaired or replaced at no charge. If the unit is determined to be out of warranty, it will be repaired for a nominal service charge plus return freight. Send the unit pre-paid to:

Attn: LAUNCH Tech USA
1820 South Milliken Ave.
Ontario, CA 91761