

Version: V1.00.000
Revised date: 10-18-2022

Statement:

All information, specifications and illustrations in this manual are based on the latest information available at the time of release. LAUNCH reserves the rights to make changes at any time without notice.

Copyright Information

Copyright © 2022 by LAUNCH TECH CO., LTD (also called LAUNCH for short). All rights reserved. No part of this publication may be reproduced, stored in a retrieval system, or transmitted in any form or by any means, electronic, mechanical, photocopying, recording or otherwise, without the prior written permission of LAUNCH.

Statement: LAUNCH owns the complete intellectual property rights for the software used by this product. For any reverse engineering or cracking actions against the software, LAUNCH will block the use of this product and reserve the right to pursue their legal liabilities.

Disclaimer of Warranties and Limitation of Liabilities

All information, illustrations, and specifications in this manual are based on the latest information available at the time of publication.

The right is reserved to make changes at any time without notice. We shall not be liable for any direct, special, incidental, indirect damages or any economic consequential damages (including the loss of profits) due to the use of the document.

Using This Manual

This manual contains device usage instructions.

Some illustrations shown in this manual may contain modules and optional equipment that are not included in your system.

The following conventions are used.

Bold Text

Bold text is used to highlight selectable items such as buttons and menu options.

Example:

Tap **OK**.

Notes and Important Messages

Notes

A NOTE provides helpful information such as additional explanations, tips, and comments.

Example:

 Note: Remember to remove the VCI connector from the vehicle's DLC after use.

Warning

Warning indicates a hazardous situation which, if not avoided, could result in minor or moderate injury to the operator or to bystanders.

Example:

 Warning: Retrieving and using DTCs for troubleshooting vehicle operation is only one part of an overall diagnostic strategy. Never replace a part based only on the DTC definition. Each DTC has a set of testing procedures, instructions and flow charts that must be followed to confirm the location of the problem. This information can be found in the vehicle's service manual.

Danger

Danger indicates an imminently or potentially hazardous situation which, if not avoided, could result in death or serious injury to the operator or to bystanders.

Example:

 Danger: If you must drive the vehicle in order to perform a troubleshooting

procedure, always have a second person help you. Trying to drive and operate the diagnostic tool at the same time is dangerous, and could cause a serious traffic accident.

Illustrations

Illustrations used in this manual are samples, the actual testing screen may vary for each vehicle being tested. Observe the menu titles and on-screen instructions to make correct option selection.

Important Safety Precautions

To avoid personal injury, property damage, or accidental damage to the product, read all of the information in this section before using the tool.

DANGER

- When an engine is operating, keep the service area well-ventilated or attach a building exhaust removal system to the engine exhaust system. Engines produce various poisonous compounds (hydrocarbon, carbon monoxide, nitrogen oxides, etc.) that cause slower reaction time and result in death or serious personal injury.
- Please use the included battery and power adaptor. Risk of explosion if the battery is replaced with an incorrect type.
- DO NOT attempt to operate the tool while driving the vehicle. Have second person operate the tool. Any distraction may cause an accident.

WARNING

- Always perform automotive testing in a safe environment.
- Do not connect or disconnect any test equipment while the ignition is on or the engine is running.
- Before starting the engine, put the gear lever in the Neutral position (for manual transmission) or in the Park (for automatic transmission) position to avoid injury.
- NEVER smoke or allow a spark or flame in vicinity of battery or engine. Do not operate the tool in explosive atmospheres, such as in the presence of flammable liquids, gases, or heavy dust.
- Keep a fire extinguisher suitable for gasoline/chemical/electrical fires nearby.

- Wear an ANSI-approved eye shield when testing or repairing vehicles.
- Put blocks in front of the drive wheels and never leave the vehicle unattended while testing.
- Use extreme caution when working around the ignition coil, distributor cap, ignition wires and spark plugs. These components create hazardous voltage when the engine is running.
- To avoid damaging the tool or generating false data, please make sure the vehicle battery is fully charged and the connection to the vehicle DLC (Data Link Connector) is clear and secure.
- Automotive batteries contain sulfuric acid that is harmful to skin. In operation, direct contact with the automotive batteries should be avoided. Keep the ignition sources away from the battery at all times.
- Keep the tool dry, clean, free from oil, water or grease. Use a mild detergent on a clean cloth to clear the outside of the equipment when necessary.
- Keep clothing, hair, hands, tools, test equipment, etc. away from all moving or hot engine parts.
- Store the tool and accessories in a locked area out of the reach of children.
- Do not use the tool while standing in water.
- Do not expose the tool or power adapter to rain or wet conditions. Water entering the tool or power adaptor increases the risk of electric shock.
- This tool is a sealed unit. There are no end-user serviceable parts inside. All internal repairs must be done by an authorized repair facility or qualified technician. If there is any inquiry, please contact the dealer.
- Keep the tool far away from magnetic devices because its radiations can damage the screen and erase the data stored on the tool.
- Do not attempt to replace the internal rechargeable lithium battery. Contact the dealer for factory replacement.
- Do not disconnect battery or any wiring cables in the vehicle when the ignition switch is on, as this could avoid damage to the sensors or the ECU.
- Do not place any magnetic objects near the ECU. Disconnect the power supply to the ECU before performing any welding operations on the vehicle.
- Use extreme caution when performing any operations near the ECU or sensors. Ground yourself when you disassemble PROM, otherwise ECU and sensors can be damaged by static electricity.

- When reconnecting the ECU harness connector, be sure it is attached firmly, otherwise electronic elements, such as ICs inside the ECU, can be damaged.

FCC Statement

Any Changes or modifications not expressly approved by the party responsible for compliance could void the user's authority to operate the equipment.

This device complies with part 15 of the FCC Rules. Operation is subject to the following two conditions: (1) This device may not cause harmful interference, and (2) this device must accept any interference received, including interference that may cause undesired operation.

Note: This equipment has been tested and found to comply with the limits for a Class B digital device, pursuant to Part 15 of the FCC Rules. These limits are designed to provide reasonable protection against harmful interference in a residential installation.

This equipment generates, uses, and can radiate radio frequency energy, and if not installed and used in accordance with the instructions, may cause harmful interference to radio communications. However, there is no guarantee that interference will not occur in a particular installation. If this equipment does cause harmful interference to radio or television reception, which can be determined by turning the equipment off and on, the user is encouraged to try to correct the interference by one or more of the following measures:

- Reorient or relocate the receiving antenna.
- Increase the separation between the equipment and receiver.
- Connect the equipment into an outlet on a circuit different from that to which the receiver is connected.
- Consult the dealer or an experienced radio/TV technician for help.

TABLE OF CONTENTS

1 Introduction	1
1.1 Product Profile.....	1
1.2 Package List.....	1
2 Components & Controls	3
2.1 Display Tablet.....	3
2.2 SmartLink C Device.....	5
2.3 Technical Specifications	6
3 Initial Use	7
3.1 Charging & Turning On.....	7
3.2 Screen Layout	7
3.3 Basic Gestures	8
3.4 Change System Language	8
3.5 Adjust Brightness	8
3.6 Set Standby Time.....	9
3.7 Network Setup.....	9
4 Getting Started	10
4.1 Register & Update	10
4.2 Job menu	12
4.2.1 Diagnostics	13
4.2.1 Toolbox.....	14
4.3 Connections	15
4.3.1 Preparation	15
4.3.2 Vehicle connection	15
4.4 Communication Setup	16
5 Diagnosis	17

5.1 Smart Diagnosis (AutoDetect)	18
5.2 Manual Diagnosis	22
5.3 Tech 2 Tech	37
5.3.2.1 Request remote help	39
5.3.2.2 Provide remote help	45
5.4 Diagnostic History.....	50
6 Diagnostic Feedback	51
7 I/M Readiness	52
8 Reports	55
9 Software Update.....	57
9.1 Update Diagnostic Software & APP	57
9.2 Update Frequently Used software	58
9.3 Renew Subscription.....	59
10 Profile	60
10.1 VCI Management.....	60
10.2 ROXIE Management	61
10.3 Sample	62
10.4 My Order	62
10.5 Subscription Renewal Card	62
10.6 Profile	62
10.7 Change Password	62
10.8 Settings	62
10.8.1 General	62
10.8.2 Shop Information.....	63
10.8.3 Printer Set	63
10.8.4 Clear Cache	65
10.8.5 Login/Logout	65

10.9 Diagnostic Software Clear	65
11 Add-on Modules	67
11.1 TPMS	67
11.2 ADAS (Calibration)	67
11.3 Videoscope.....	67
11.4 BST360 (Battery Tester).....	67
11.5 Immobilizer Programmer	67
11.6 Mall.....	68
12 FAQ	70

1 Introduction

1.1 Product Profile

This tool is a new Android-based vehicle diagnostic tool. It is characterized by featuring powerful functions, and providing precise test result.

Through Bluetooth communication between the VCI (Vehicle Communication Interface) and display tablet, it achieves full car model and full system vehicle trouble diagnosis, which include Reading DTCs, Clearing DTCs, Reading Data Stream, Actuation Test and Special Functions.

It mainly has the following features and advantages:

- **Diagnose**: AutoDetect and manual diagnosis are available.
- **I/M Readiness**: Check whether or not the various emissions-related systems on the vehicle are operating properly, and ready for Inspection and Maintenance testing.
- **Tech 2 Tech**: This option aims to help repair shops or technicians launch instant messaging and remote diagnosis, making the repair job getting fixed faster.
- **One-click Update**: Lets you update your diagnostic software online.
- **Diagnostic feedback**: Enables you to submit the vehicle issue to us for analysis and troubleshooting.
- **Diagnostic History**: This function provides a quick access to the tested vehicles and users can choose to view the test report or resume from the last operation, without starting from scratch.
- **Vehicle Coverage**: Quick dial to view the vehicle models that the tool covers.
- **Add-on modules**: TPMS, ADAS calibration, Videoscope, BST360 battery tester, Immobilizer Programmer and Mall are available to extend the functions of the diagnostic tool.

1.2 Package List

The following accessory items are only for reference. Please consult from the seller or check the package list supplied with the tool together.

No.	Item	Descriptions	Qt.
1	Display tablet	Indicates the test result.	1
2	VCI	Collects vehicle data and sends it to the tablet for analysis.	1
3	VCI extension cable	Connects the VCI to the OBD II vehicle's DLC.	1
4	Power adaptor	For charging the tablet via AC outlet.	1
5	Type A to Type B data cable	Connects the VCI module to the tablet to perform vehicle diagnosis.	1
6	Type A to Type C data cable	Connects the tablet to a PC to exchange data.	1
7	Password envelope	A piece of paper bearing the product Serial Number and Activation Code for product registration.	1
8	Quick Start Guide	A quick reference guide to product operations.	1

2 Components & Controls

There are two main components to the diagnostic system:

- Display tablet – the central processor and monitor for the system (See Chapter 2.1).
- VCI – the device for accessing vehicle data (See Chapter 2.2).

2.1 Display Tablet

The tablet acts as the central processing system, which is used to receive and analyze the live vehicle data from the VCI and then output the test result.

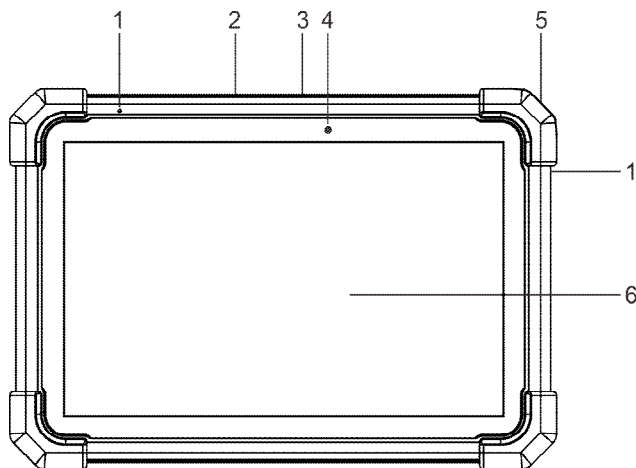

1. Microphone

2. Type-A USB Port

- Connect to the VCI connector to perform vehicle diagnosis via the USB cable.
- Connect to compatible add-on modules (such as Videoscope) or USB storage devices.

3. Type-C USB Port

- Connect to AC outlet for charging.
- Connect to PC for data exchange.

4. Front Camera

5. POWER Key

In Off mode, press it for 3 seconds to turn the tablet on.

In On mode:

- Press it once to activate the LCD if the LCD is off. Press it once to turn off the LCD if the LCD lights up.
- Press and hold it for 3 seconds to turn it off.
- Press and hold it for 8 seconds to perform forced shutdown.

6. LCD Screen

Indicate the test result.

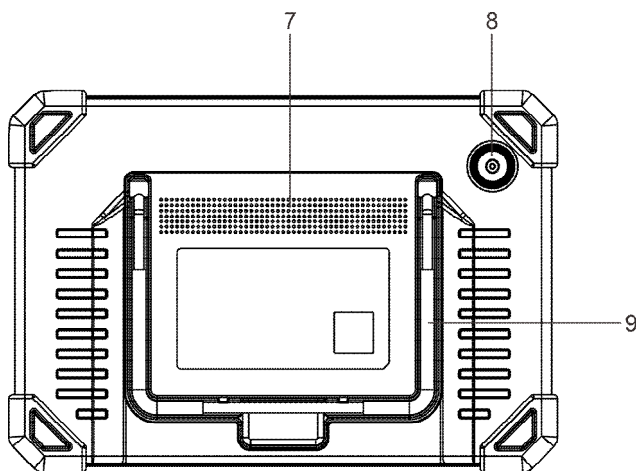

7. Speakers

8. Rear Camera

9. Adjustable stand

Flip it out to any angle and work comfortable at your desk, or hang it on steering wheel.

2.2 SmartLink C Device

The SmartLink C device works as a VCI (Vehicle Communication Interface) device. It is used to read the vehicle data and then send it to the tablet via wireless (BT) communication or data cable connection.

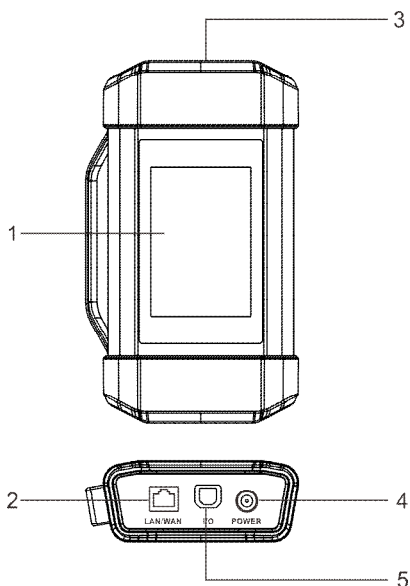

1. Touch screen

2. LAN/WAN port

Connect the SmartLink C device to the Internet via the crossover cable. It only applies to the SmartLink Super Remote Diagnostics.

3. OBD-16 diagnostic connector

Connect the SmartLink C device to the vehicle's DLC (Data Link Connector) port via the VCI extension cable.

4. DC-IN power jack

Currently disabled and for manufacturer use only.

*Warning: The SmartLink C device obtains power through the vehicle's DLC, and it is prohibited to connect to an external DC power supply. No responsibility can be assumed for any damage or loss caused as a result of not strictly following the above method.

5. Data I/O port

Connect the SmartLink C device to the tablet to perform vehicle diagnosis.

2.3 Technical Specifications

1. Display tablet

Operating system: Android

Memory: 4GB

Storage: 128GB

Screen: 10.1 inch capacitive touch screen with a resolution of 1280 x 800 pixels

Camera: Front-facing 5.0MP + Rear-facing 8.0MP camera

Connectivity

- Wi-Fi (802.11a/b/g/n/ac)
- Bluetooth

Working temperature 0°C ~ 50°C

Storage temperature -20°C ~ 70°C

2. VCI

Size: 204mm x 110mm x 45mm

Working voltage: DC 9~36V

Power consumption: ≤ 6W

Communication: Bluetooth/Wi-Fi or data cable connection

Working temperature: 0°C ~ 50°C

3 Initial Use

3.1 Charging & Turning On

1. Use the included power adaptor to charge the tablet.
2. After charging is complete, press the POWER button to turn the tablet on. The system starts initializing and then enters the home screen.

*Note: If the battery remains unused for a long period of time or the battery is completely discharged, it is normal that the tool will not power on while being charged. Please charge it for a period of 5 minutes and then turn it on.

*Warning: Please use the included power adaptor to charge your tool. No responsibility can be assumed for any damage or loss caused as a result of using power adaptors other than the one supplied.

Press [POWER] for 3 seconds, an option menu will pop up on the screen. Tap **Power off** to turn the tool off.

3.2 Screen Layout

There are five on-screen buttons available on the bottom of the screen.



Home: Navigates to the Android's home screen.



Recent App: Views the recently launched applications and running applications.



VCI Connection: Shows whether the VCI device is properly connected or not.



Screenshot: Captures the current screen.



Back: Returns to the previous screen.

3.3 Basic Gestures



Single-tap: To select an item or launch a program.



Double-tap: To zoom in so that the text on a webpage appears in a column that fits your device's screen.



Long press: Tap and hold on the current interface or area until a contextual menu pops up on the screen, and then release it.



Slide: To jump to different pages.



Drag: Tap the application icon and drop it to other location.



Spread apart/pinch together: To zoom in manually, place two fingers on the screen and then spread them apart. To zoom out, place two fingers apart on the screen and then pinch them together.

3.4 Change System Language

The tool supports multiple system languages. To change the language of the tool, please do the following:

1. On the home screen, tap **Settings -> System -> Language & input -> Languages**.
2. Tap **Add a language**, and then choose the desired language from the list.
3. Tap and hold the desired language and drag it to the top of the screen and then release it, the system will change into the target language.

3.5 Adjust Brightness

*Note: Reducing the brightness of the screen is helpful to conserve the battery power.

1. On the home screen, tap **Settings -> Display -> Brightness level**.
2. Drag the slider to adjust it.

3.6 Set Standby Time

If no activities are made within the defined standby period, the screen will be locked automatically and the system enters sleep mode to save power.

1. On the home screen, tap **Settings -> Display -> Advanced -> Sleep**.
2. Choose the desired sleep time.

3.7 Network Setup

The tablet has built-in Wi-Fi that can be used to get online. Once you're online, you can register your tool, surf the Internet, get apps, send email, launch the remote diagnosis, and check for software updates etc.

1. On the home screen, tap **Settings -> Network & Internet -> WLAN**.
2. Slide the Wi-Fi switch to ON, the tablet starts searching for available wireless networks.
3. Select a wireless network,
 - If the chosen network is open, the tablet will connect automatically.
 - If the selected network is encrypted, a network password will need to be entered.
4. When **Connected** appears, it indicates the Wi-Fi connection is complete.

*Note: When Wi-Fi is not required, this should be disabled to conserve battery power.

4 Getting Started

For new users, you will need to experience a user registration process before getting started.

4.1 Register & Update

Follow the steps below to proceed registration and update:

Tap the application icon on the home screen to launch it, and then tap **Login** to enter the login interface of diagnosis software.

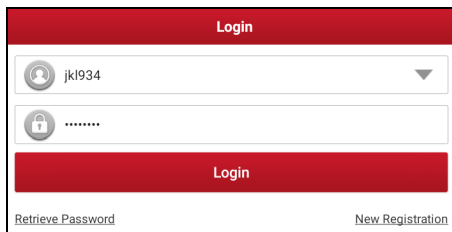

(If you are a new user, follow **A** to proceed.)

(If you have registered to be a member, go to **B** to login the system directly.)

(In case you forgot password, refer to **C** to reset a new password.)

a) If you are a new user, tap **New Registration** to enter sign-up page.

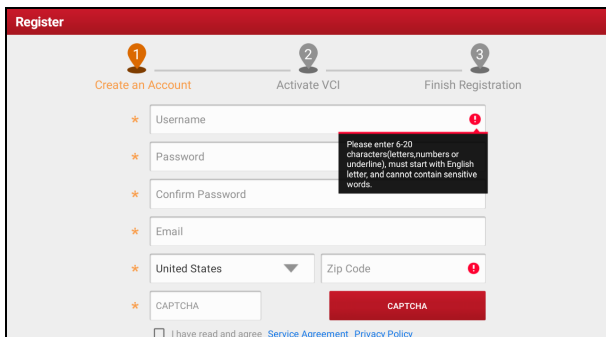

1. Create an App Account: Input the information to create a new account (all fields must be completed). When finished tap **Register**, the following screen will appear:

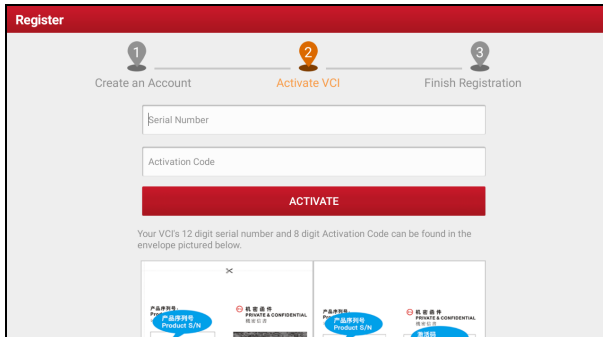

2. Activate VCI: Input the Product Serial Number and Activation Code (can be found in the supplied Password Envelope), and tap **Activate** to go to the next step.

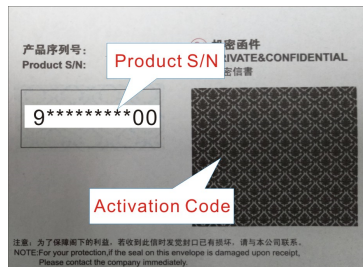

*Note: To exit and activate it later, tap **Skip**. In this case, you can activate the VCI by tapping **Profile -> VCI Management**.

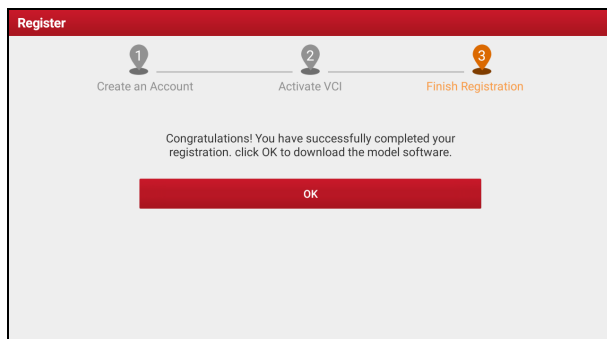

3. Finish Registration: Tap **OK** to navigate to the download page and download the diagnostic software.

Tap **Update** to start downloading. To pause downloading, tap **Stop**. After the downloading is complete, the system will install the software package automatically.

*Note: When downloading the diagnostic software or checking for updates, make sure the tablet has a strong Wi-Fi connection. It may take a long time to finish it, please be patient to wait.

- b) If you have registered to be a member, input your name and password, and then tap the **Login** button to enter the main menu screen directly.

*Note: The tablet has an auto-save function. Once the username and password are correctly entered, the system will automatically store it. After initial setup, it is no longer necessary to input the account information manually to log in.

- c) If you forgot the password, tap **Retrieve password** and then follow on-screen instructions to set a new password.

4.2 Job menu

There are 2 function modules available on the tablet: Diagnostics and Toolbox. Swipe in from the left/right edge of the screen to switch between function modules.

4.2.1 Diagnostics

It mainly includes the following items:

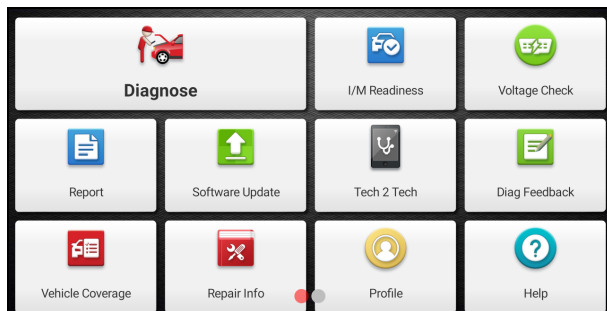

Name	Description
Diagnose	Configure the tablet as a professional diagnostic tool.
I/M Readiness	Check whether or not the various emissions-related systems on the vehicle are operating properly, and ready for Inspection and Maintenance testing.
Voltage Check	Perform a check of the vehicle's battery to ensure the system is operating within acceptable limits.
Report	View Health report, ADAS reports, Remote report, ROXIE Reports and Recorded Data.
Software Upgrade	Update vehicle diagnostic software and APK.
Tech 2 Tech	This option aims to help repair shops or technicians launch instant messaging and remote diagnosis, making the repair job getting fixed faster.
Diag Feedback	To feed back the recent 20 diagnostic logs to us for issue analysis.
Vehicle Coverage	To view all the vehicle models that the tablet covers.
Repair Info	Provide quick access to various authorized automotive repair database.

Profile	To manage VCI, reports, change password, configure printer, system settings and logout etc.
Help	Include customer service phone and email, training videos, FAQ and user manual of add-on modules.

4.2.1 Toolbox

It mainly includes the following items:

Name	Description
TPMS	Configure this tool as a professional TPMS (Tire Pressure Monitoring System) service tool. It needs to work with the TSGUN device (sold separately) to perform all kinds of various TPMS functions.
ADAS	This module allows you to perform ADAS (Advanced Driver Assistance System) calibration operations. It needs to work with the specific ADAS calibration tool (sold separately).
Videoscope	This module allows you to check those unseen parts of engine, fuel tank, braking system. It needs to work with the compatible Videoscope device (sold separately).
BST360	This module allows you to fix battery detection faster and easier. It needs to work with the specific Bluetooth battery tester (sold separately).
Immo Programmer	This module allows you to perform the read-write function for vehicle keys, EEPROM, MCU, and EEPROM/FLASH of vehicle engine and gearbox ECU. It needs to work with the specific immobilizer programmer (sold separately).
Mall	Subscribe some extra software or service functions that are not included in the diagnostic tool online.

4.3 Connections

4.3.1 Preparation

1. Make sure that the vehicle battery voltage is 11~14 and the ignition is turned on.
2. Find the vehicle's DLC location:

For Passenger Vehicles, The DLC(Data Link Connector) is usually located 12 inches from the center of the instrument panel, under or around the driver's side for most vehicles. For some vehicles with special designs, the DLC location may vary. Refer to the following figure for location.

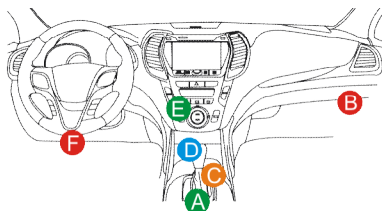

- A. Opel, Volkswagen, Audi
- B. Honda
- C. Volkswagen
- D. Opel, Volkswagen, Citroen
- E. Changan
- F. Hyundai, Daewoo, Kia, Honda, Toyota, Nissan, Mitsubishi, Renault, Opel, BMW, Mercedes-Benz, Mazda, Volkswagen, Audi, GM, Chrysler, Peugeot, Regal, Beijing Jeep, Citroen and other most popular models

If the DLC cannot be found, refer to the vehicle's service manual for the location.

4.3.2 Vehicle connection

The method used to connect the VCI device to a vehicle's DLC depends on the vehicle's configuration as follows:

- A. OB2 II Vehicle Connection: Plug one end of the VCI extension cable into the vehicle's DLC, and the other end into the diagnostic socket of the VCI device,

and then tighten the captive screws.

- B. **Non-OBD II Vehicle Connection:** For vehicles with non-OBD II diagnostic socket, a non-16pin adaptor cable (not included) is required. Follow the illustration below to proceed:

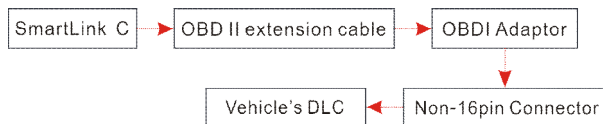

*Note: If the power supply on vehicle diagnostic socket is insufficient or the power pin is damaged, you can get power via either of the following ways:

- A. Via Battery clamps cable (optional): Connect one end of the battery clamps cable to the power jack of the OBD I adaptor box, and the other end to the vehicle's battery.
- B. Via Cigarette lighter cable (optional): Connect one end of the cigarette lighter cable to the power jack of the OBD I adaptor box, and the other end to the cigarette lighter receptacle.

4.4 Communication Setup

After the VCI device is successfully activated and powered on, the VCI device will pair with the tablet automatically. Users have no need to make any setting any more.



Once the communication failure occurs, the diagnostic app will pop up some prompt information. In this case, just follow the on-screen prompts to troubleshoot all possible causes.

5 Diagnosis

Three methods are available for vehicle diagnosis: Smart Diagnosis (AutoDetect), Manual Diagnosis and Tech to Tech Remote Diagnosis.

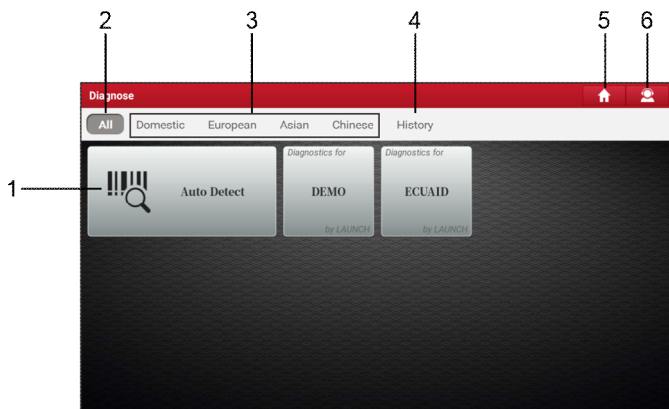
Tap **Diagnose** on the Job Menu to enter the Diagnose main menu.



1. Auto Detect: Obtain vehicle data from the cloud server to perform quick test via reading VIN, to avoid various defects resulting from step-by-step menu selection.
2. All Tab: Display all the vehicle makes in the vehicle menu.
3. Vehicle region buttons: Tap different buttons to switch to corresponding vehicles.
4. History: Generally once a vehicle diagnosis is performed, the tablet will record the every details of diagnostic session. The History function provides direct access to the previously tested vehicles and users can resume from the last operation, without starting from scratch. Refer to Chapter 5.4 for details.
5.  **Home**: Returns to Job menu screen.
6.  **Online technical help**: Tap to seek for online remote help.

5.1 Smart Diagnosis (AutoDetect)

Through simple Bluetooth communication between the display tablet and VCI, you can easily get the VIN (Vehicle Identification Number) information of the currently identified vehicle. Once the VIN is successfully identified, the system will retrieve it from the remote server and then guide you to vehicle information page without step-by-step manual menu selection.

The vehicle information page lists all historical diagnostic records of the vehicle, which lets the technician have a total command of the vehicle faults. In addition, a quick dial to local diagnosis and diagnostic function are also available on this page for reducing the roundabout time and increasing productivity.

*Note: Before using this function, please make sure the VCI is properly connected to the vehicle's DLC. For detailed connection, see Chapter 4.3.

Follow the steps below to proceed.

1. Tap **AutoDetect** on the Diagnose main menu screen.

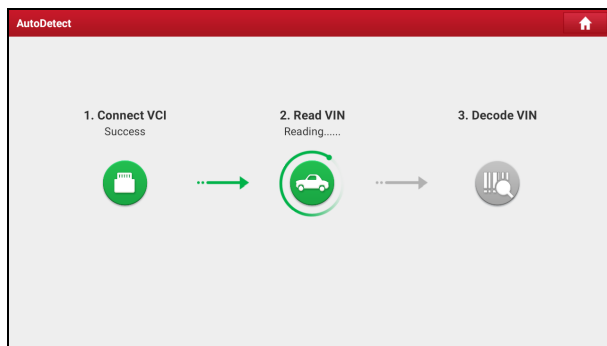

2. Once pairing is complete, the tablet starts reading the vehicle VIN.
 - A. If the VIN can be found from the remote server database, the following screen will appear.

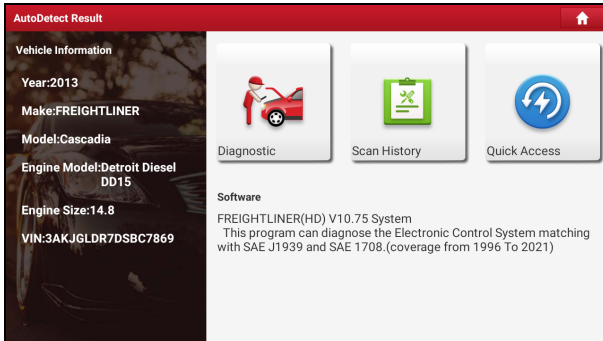

- Tap **Diagnostic** to start a new diagnostic session.
- Tap **Scan History** to view its historical repair record. If there are records available, it will be listed on the screen in sequence of date.

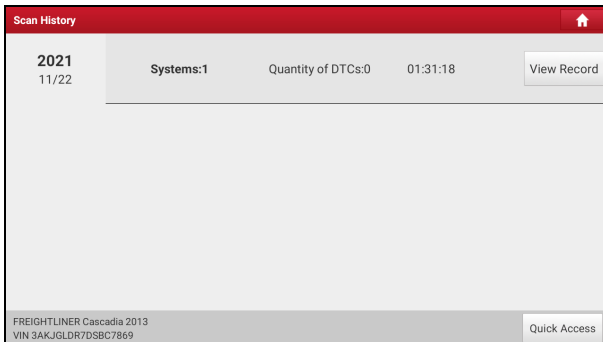

- To perform other functions, tap **Quick Access** to directly go to the function selection screen. Choose the desired one to start a new diagnostic session.

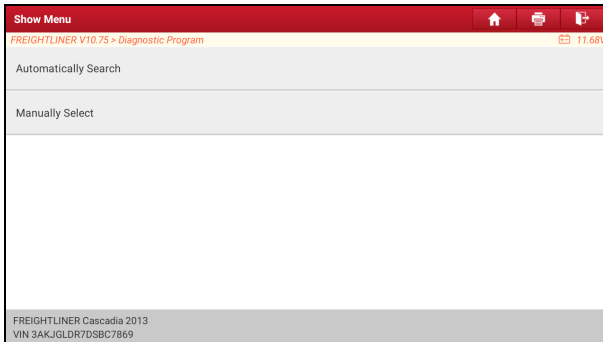



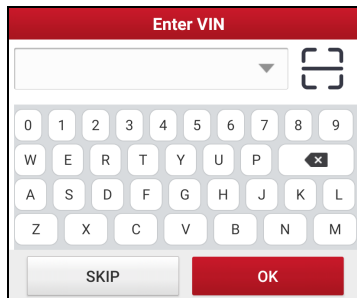

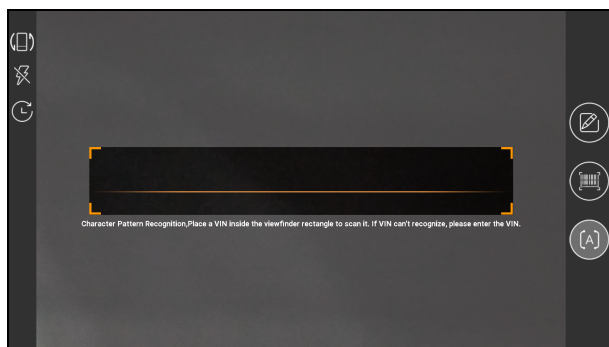

B. If the tablet failed to access the VIN information, the following screen will appear:



- Tap the input field to directly, tap **OK**. If the VIN exists on the remote server, the system will enter the diagnostic function selection screen.
- Tap  to launch the VIN recognition module.



Place the VIN inside the viewfinder rectangle to scan it. The most recognizable location for this number is in the top left corner on the vehicle's dashboard. Other locations include the driver's door or post, and the firewall under the hood.

- Tap  to switch the display mode of the screen.
- Tap  to turn the camera flash on.
- Tap  to choose it from the record list if the VIN of the vehicle has been scanned before.
- Tap  to input the VIN manually if the tablet has failed to identify the VIN of the vehicle.
- Tap  to scan the VIN barcode. If the VIN barcode cannot be recognized, please manually input the VIN.
- Tap  to scan the VIN character. If the VIN character cannot be recognized, please manually input the VIN.

After scanning, the screen will automatically display the result.

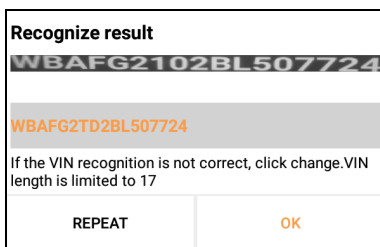

- If the VIN scanned is incorrect, tap the result field to modify it and then tap **OK**.
- To scan it again, tap **REPEAT**.

If the VIN exists on the remote server, the system will enter the diagnostic function selection screen.

5.2 Manual Diagnosis

In this mode, you need to execute the menu-driven command and then follow the on-screen instruction to proceed.

Take **Demo** as an example to demonstrate how to diagnose a vehicle.

- 1). Select diagnostic software version: Tap **DEMO** to go to Step 2. (*Note: If more than one version is available on this tablet, it will be listed on the screen.)

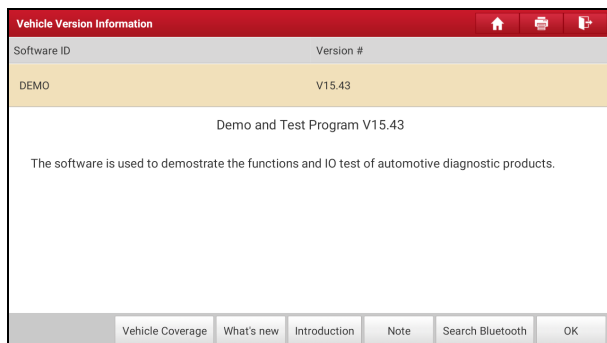

On-screen Buttons:

Vehicle Coverage: Tap to view the vehicle models that the current diagnostic software covers.

What's new: Tap to view the optimized items and enhancements.

Introduction: Tap to check the software function list.

Note: Tap to read some precautions on using the current diagnostic software.

Search Bluetooth: Tap to scan for all available Bluetooth VCIs.

OK: Tap it to go to next step.

Diagnostics toolbar contains a number of buttons that allow you to print the displayed data or make other controls. It is displayed on the upper right corner of the screen and goes through the whole diagnostic session. Below provides a brief description for the operations of the diagnostics toolbar buttons:

 Home: Returns to Job menu screen.

 Print: Print the current screen. To perform printing, you need to purchase an extra Wi-Fi printer manufactured by LAUNCH or other manufacturers separately and then properly configure the wireless printer following the steps described in Chapter 10.8.3.

 Exit: To exit the diagnostic application.

2). **Select vehicle model (varies with different versions):** Select the desired vehicle model. Here we take **Ford** for example.

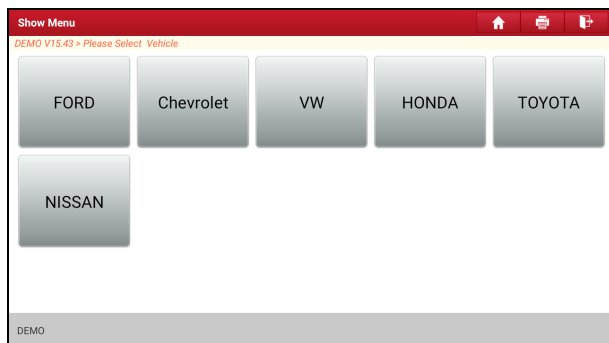

3). **Read vehicle information:** The system automatically decodes the vehicle

information. After the vehicle information is retrieved, the following screen will appear.

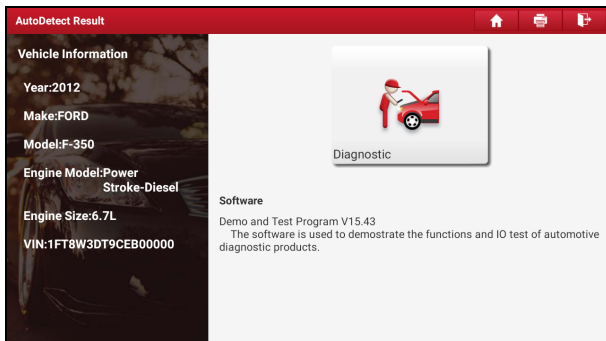

- 4). Choose the test item: After reading the vehicle information, double check if the information is correct or not. If yes, tap **Diagnostic** to enter the following screen.

All vehicle systems can be displayed in form of topology or list. By default, all vehicle systems are displayed in form of topology.

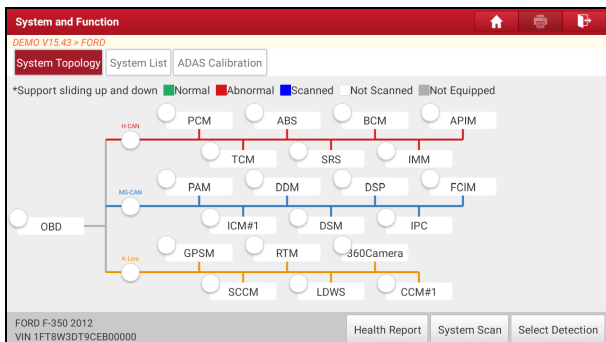

- 1) While in System Topology mode, different highlight bars indicate different detection status.

On-screen Buttons:

Health Report: Tap to quickly access all the electronic control units of the

vehicle and generate a detailed report about vehicle health. The tested systems malfunctioning are displayed in red with a number indicator displaying DTC quantity and the systems with functioning properly are displayed in green.

*Note: Diagnostic Trouble Codes or Fault Codes can be used to identify which engine systems or components that are malfunctioning. Never replace a part based only on the DTC definition. Retrieving and using DTCs for troubleshooting vehicle operation is only one part of an overall diagnostic strategy. Follow testing procedures (in vehicle's service manual), instructions and flowcharts to confirm the locations of the problem.

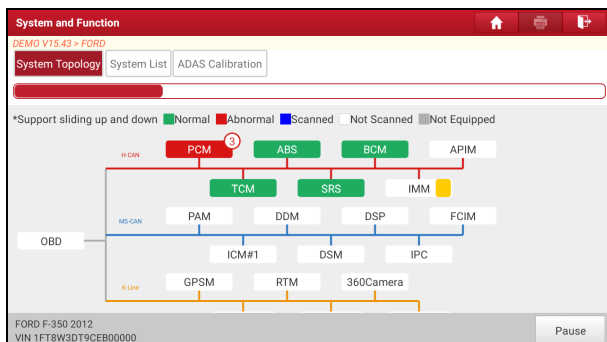

- **Report:** Tap to save the current data in text format.

Choose the report type and input the required information, and then tap **OK**.

*Note: Diagnostic report is classified into two categories: Pre-Repair report and

Post-Repair report. To facilitate the comparison of the pre-repair and post-repair reports and get accurate test result, please make sure you saved the right type of the diagnostic report.

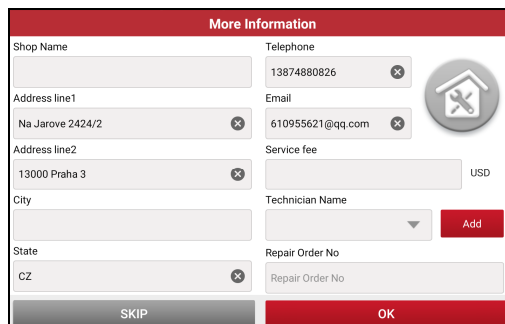

More Information	
Shop Name	Telephone
<input type="text"/>	13874880826
Address line1	Email
Na Jarove 2424/2	610955621@qq.com
Address line2	Service fee
13000 Praha 3	<input type="text"/> USD
City	Technician Name
<input type="text"/>	<input type="text"/> Add
State	Repair Order No
CZ	<input type="text"/>
SKIP	OK

Enter the tester and customer name and then tap **OK** to save it. All reports are saved in **Report -> Health Reports**.

*Note: By default, the workshop information is blank. You can configure and revise it from **Profile -> Settings -> Shop Information**. After you configured the information, it will be automatically generated every time the diagnostic report is saved. All vehicle and workshop information will be appended as a tag on the diagnostic report, which allows you to easily retrieve the desired report while performing the Filter function of Diagnostic Report.

- **Compare Results**: Tap to select the pre-repair report to compare. By comparison of the pre- and post- repair reports, you can easily identify which DTCs are cleared and which remain unfixed.

Compare Results		
DEMO V15.43 > FORD		
DTC	Current	History
PCM (Powertrain Control Module)		
P0401 EGR Valve A Flow Insufficient Detected	Found	N/A
P1291 Injector High Side Short To GND Or VBATT (Bank1)	Found	N/A
P2073 Manifold Absolute Pressure/Mass Air Flow-Throttle correlation at idle	Found	N/A
LDWS(Lane Departure Warning System) Camera Alignment		
C1522 CAN bus-Fault	Found	N/A

*Note: Before performing this function, please make sure that: 1) You have saved a pre-repair report of the currently tested vehicle; and 2) You have already made some repairs and service and cleared the DTCs after the pre-repair reported is generated. Otherwise, no differences exist between the pre- and post-repair reports.

- **Diagnostic Plan:** Figures out the diagnostic plan and repair solutions for the detected DTCs.

Diagnostic Plan	
PCM (Powertrain Control Module): 3 DTC(s)	
P0401 Current <input type="button" value="Online Help"/>	P1291 Current <input type="button" value="Online Help"/>
EGR Valve A Flow Insufficient Detected <input type="button" value="Online Help"/>	Injector High Side Short To GND Or VBATT (Bank1) <input type="button" value="Online Help"/>
P0401 Demo Help Possible Failures...	P1291 Demo Help Possible Failures...
P2073 Current <input type="button" value="Online Help"/>	
Manifold Absolute Pressure/ Mass Air Flow-Throttle correlation at idle <input type="button" value="Online Help"/>	
P0303 Demo Help	

- **Clear DTCs:** Tap to clear the existing diagnostic trouble codes.

*Note: Clearing DTCs does not fix the problem(s) that caused the code(s) to be set. If proper repairs to correct the problem that caused the code(s) to be set are not made, the code(s) will appear again and the check engine light will illuminate

as soon as the problem that cause the DTC to set manifests itself.

System Scan: Tap to quickly scan which systems are installed on the vehicle.

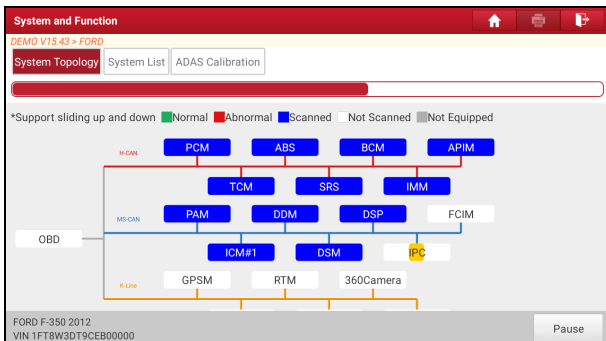

Select Detection: Select certain system and tap it to start scanning the system.

Alternatively user also can tap certain system to manually scan it.

- 2) While in System List mode, different highlight bars indicate different detection status.

System	Detection Status	Action
PCM (Powertrain Control Module)	Not Scanned	Enter
TCM(Transmission Control Module)	Not Scanned	Enter
ABS(Anti-lock Braking System)	Not Scanned	Enter
RCM (Restraint Control Module)	Not Scanned	Enter
BCM(Body Control Module)	Not Scanned	Enter

- **Enter:** Select certain system, and tap this button to enter the diagnostic function selection screen.

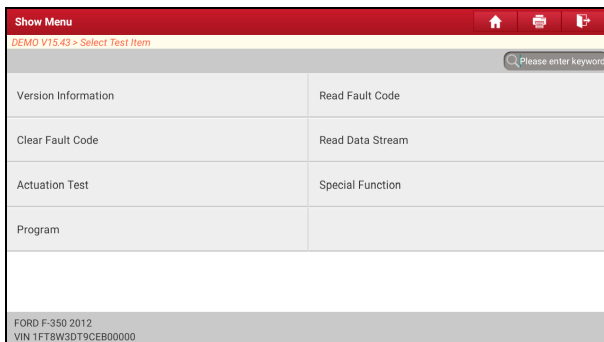

In general, the diagnostic functions vary with different vehicle models. It mainly includes the following options:

A. Module Information

This function is used to read the version information of system mode, vehicle VIN, software and ECU.

B. Read Fault Code

This function displays the detailed information of DTC records retrieved from the vehicle’s control system.

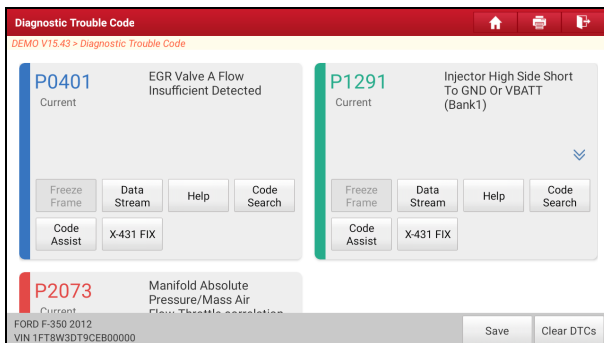

On-screen Buttons:

Freeze Frame: When an emission-related fault occurs, certain vehicle

conditions are recorded by the on-board computer. This information is referred to as freeze frame data. Freeze frame data includes a snapshot of critical parameter values at the time the DTC is set.

Help: Tap to view the help information.

Code Search: Tap it to search for more information about the current DTC online.

Code Assist: Tap it to retrieve more information (including code and definition, potential causes and frequent fixes) from the DTC database.

2012 FORD F-350 1FT8W3DT9CEB00000 6.7L Power Stroke-Diesel	
Code and Definition	
P0401 EGR 'A' Flow Insufficient Detected	
Top Reported Fix	
Replaced Exhaust Gas Recirculation (EGR) Cooler	
Potential Causes	
Contaminated Intake Air Sensor	
Exhaust Gas Re-Circulation (EGR) Control Valve	
Exhaust Gas Recirculation (EGR) Cooler	

Report: To save the current data in text format. All reports are saved in **Report -> Health Reports**.

Clear DTCs: Tap to clear the existing diagnostic trouble codes.

C. Clear Fault Code

After reading the retrieved codes from the vehicle and certain repairs have been carried out, you can use this function to erase the codes from the vehicle. Before performing this function, please be sure the vehicle's ignition key is in the ON position with the engine off.

Clearing DTCs does not fix the problem(s) that caused the code(s) to be set. If proper repairs to correct the problem that caused the code(s) to be set are not made, the code(s) will appear again and the check engine light will illuminate as soon as the problem that cause the DTC to set manifests itself.

*Note: After clearing, you should retrieve trouble codes once more or turn ignition on

and retrieve codes again. If there are still some trouble codes in the system, please troubleshoot the code using a factory diagnosis guide, then clear the code and recheck.

D. Read Data Stream

This option lets you view and capture (record) real-time Live Data. This data including current operating status for parameters and/or sensor information can provide insight on overall vehicle performance. It can also be used to guide vehicle repair.

*Note: If you must drive the vehicle in order to perform a troubleshooting procedure, ALWAYS have a second person help you. Trying to drive and operate the diagnostic tool at the same time is dangerous, and could cause a serious traffic accident.

Tap **Read Data Stream**, the following screen will appear:

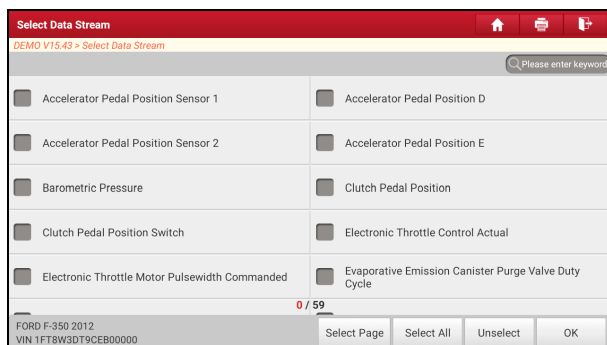

On-screen Buttons:

Select Page: Tap it to select all items of the current page. To select certain data stream item, just check the box before the item name.

Select All: Tap it to select all items.

Unselect: Tap it to deselect all data stream items.

OK: Tap it to confirm and jump to the next step.

After selecting the desired items, tap **OK** to enter the data stream reading page.

Data Stream					
DEMO V15.43 > Data Stream					
Name	Value	Standard Range	English	Metric	
Accelerator Pedal Position Sensor 1	0.9	0 - 5	V	∨	
Accelerator Pedal Position D	15.69	0 - 100	%		
Accelerator Pedal Position Sensor 2	0.46	0 - 5	V	∨	
Accelerator Pedal Position E	15.69	0 - 100	%		
Barometric Pressure	14.925	0 - 17.58	psi	∨	

FORD F-350 2012
VIN 1FT8W3DT9CEB00000

Compare Sample Save Sample Graph Report Record

*Notes:

1. Tap , the following popup will appear.



Data Stream					
DEMO V15.43 > Data Stream					
Name		B	A	English	Metric
Accelerator Pedal Position Sensor 1		B	A	V	∨
Accelerator Pedal Position D		B	A	%	
Accelerator Pedal Position Sensor 2		B	A	V	∨
Accelerator Pedal Position E		B	A	%	
Barometric Pressure		B	A	psi	∨
Clutch Pedal Position		B	A		

FORD F-350 2012
VIN 1FT8W3DT9CEB00000

CANCEL OK

Report Record

Here the user can set different display style for each selected item.

 indicates sticky top. If it is tapped, it will change into . On the data stream display screen, the data stream item with  will be shown on the top of the selected data stream list. To remove it from the top of the list, just tap it again.

B indicates this item will be displayed in **Bold**.

A indicates this item will be displayed in **Red**.

2. Tap **English** or **Metric** to switch the measurement unit.

3. If the value of the data stream item is out of the range of the standard (reference)

value, the whole line will display in red. If it complies with the reference value, it displays in blue (normal mode).

- The indicator 1/X shown on the bottom of the screen stands for the current page/total page number. Swipe the screen from the right/left to advance/return to the next/previous page.

There are 3 types of display modes available for data viewing, allowing you to view various types of parameters in the most suitable way.

- ✓ **Value** – this is the default mode which displays the parameters in texts and shows in list format.
- ✓ **Graph** – displays the parameters in waveform graphs.
- ✓ **Combine** – this option is mostly used in graph merge status for data comparison. In this case, different items are marked in different colors.

On-screen Buttons:

 **(Single graph):** Tap it to view the waveform.



- **Min/Max:** Tap it to define the maximum/minimum value. When the value goes beyond the specified value, the system will alarm.

Graph: Tap it to view the waveform.

- **Combine:** This option is mostly used in graph merge status for data comparison.
- **Value:** Tap to display the parameters in texts.
- **Customize** (33

on the screen. Select/deselect the desired items and then screen will display/remove the waveforms corresponding to these items immediately.

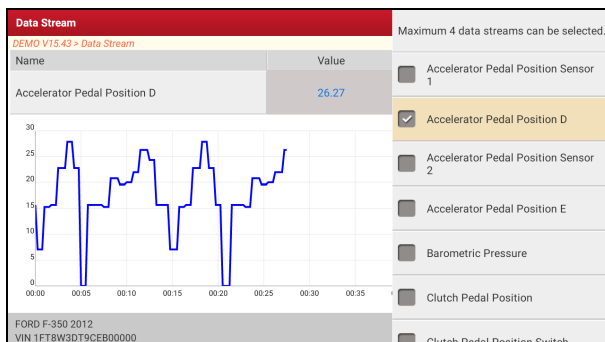

Compare Sample: Tap it to select the sample data stream file, the values you customized and saved in process of data stream sampling will be imported into the **Standard Range** column for your comparison.

Name	Value	Standard Range(Sample)	English	Metric
Accelerator Pedal Position Sensor 1	0.78	0.78 - 1.04	V	
Accelerator Pedal Position D	15.69	0 - 27.84	%	
Accelerator Pedal Position Sensor 2	0.4	0.39 - 0.55	V	
Accelerator Pedal Position E	15.69	0 - 15.69	%	
Barometric Pressure	14.925	14.92 - 14.92	psi	

FORD F-350 2012
VIN 1FT8W3D79CEB00000

Compare Sample Save Sample Graph Report Record

*Note: Before executing this function, you have to sample the values of data stream items and save it as a sample data stream file.

Report: To save the current data in text format. All reports are saved in **Report -> Health Reports**.

Record: Tap to start recording diagnostic data. Recorded live data can serve as valuable information to help you in troubleshooting of vehicle problems. All

recorded files are stored in **Report -> Recorded Data**.

Data Stream					
DEMO V15.43 > Data Stream					
Name	Value	Standard Range	English	Metric	
Accelerator Pedal Position Sensor 1	0.78	0 - 5	V	✓	
Accelerator Pedal Position D	20.78	0 - 100	%	✓	
Accelerator Pedal Position Sensor 2	0.4	0 - 5	V	✓	
Accelerator Pedal Position E	0	0 - 100	%	✓	
Barometric Pressure	14.925	0 - 17.58		00:02	
FORD F-350 2012 VIN 1FT8W3D79CEB00000					
Compare Sample		Save Sample		Graph	
Report		Record			

*Note: The saved file follows the naming rule: It begins with vehicle type, and then the record starting time and ends with .x431 (To differentiate between files, please configure the accurate system time).











Help: Tap to view the help information.

Save Sample: This item enables you to customize the standard range of live data stream items and save it as DS sample file. Each time you run the data stream items, you can call out the corresponding sample data to overwrite the current standard range.

Tap it to start recording the sample data (*Only data stream items with units will be recorded).

Data Stream					
DEMO V15.43 > Data Stream					
Name	Value	Standard Range	English	Metric	
Accelerator Pedal Position Sensor 1	0.78	0 - 5	V	✓	
Accelerator Pedal Position D	0	0 - 100	%	✓	
Accelerator Pedal Position Sensor 2	0.39	0 - 5	V	✓	
Accelerator Pedal Position E	0	0 - 100	%	✓	
Barometric Pressure	14.925	0 - 17.58		00:05	
FORD F-350 2012 VIN 1FT8W3D79CEB00000					
Compare Sample		Save Sample		Graph	
Report		Record			

Once recording is complete, tap  to stop it and navigate to the data modification screen.

Confirm Sample DS			
DEMO V15.43 > Data Stream			
Name	Min Value	Max Value	Unit
Accelerator Pedal Position D	0.0	 27.84	 %
Accelerator Pedal Position E	0.0	 15.69	 %
Accelerator Pedal Position Sensor 1	0.78	 1.04	 V
Accelerator Pedal Position Sensor 2	0.39	 0.55	 V
Barometric Pressure	99.5	 99.5	 Kpa
FORD F-350 2012 VIN 1FT8W3DT9CEB00000			Save

Tap the Min./Max. value to change it. After modifying all desired items, tap **Save** to save it as a sample data stream file. All data stream files are stored in **Profile -> Sample**.

E. Actuation Test

This option is used to access vehicle-specific subsystem and component tests. Available test vary by vehicle manufacturer, year, and model.

During the actuation test, the tablet outputs commands to the ECU in order to drive the actuators, and then determines the integrity of the system or parts by reading the ECU data, or by monitoring the operation of the actuators, such as switching a injector between two operating states.

On the diagnostic function selection screen, tap **Actuation Test**, the following screen will appear:

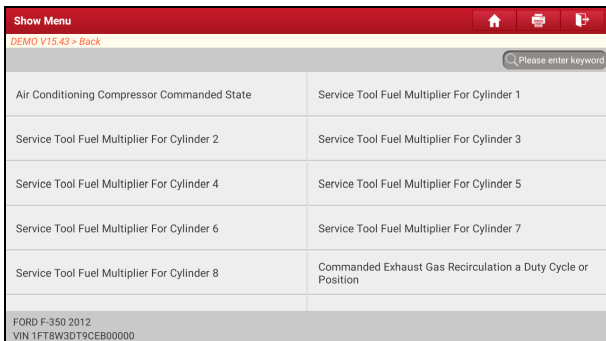

Simply follow the on-screen instructions and make appropriate selections to complete the test.

Each time when an operation is successfully executed, *Completed* displays.

F. Special Functions

It offers coding, reset, relearn and more service functions, to help vehicles get back to functional status after repair or replacement. Available tests vary by vehicle manufacturer, year, and model.

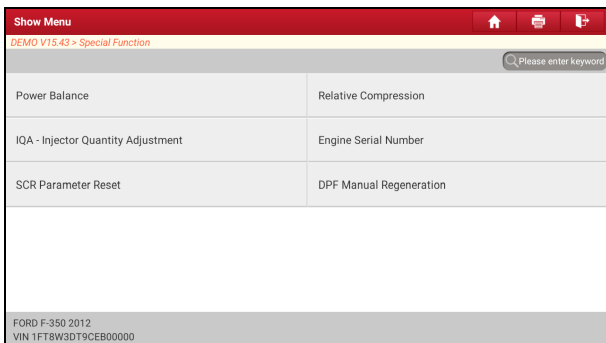

5.3 Tech 2 Tech

This option aims to help repair shops or technicians launch instant messaging

and remote diagnosis, making the repair job getting fixed faster.

Tap **Tech 2 Tech** on the Job menu, a disclaimer page will pop up on the screen:

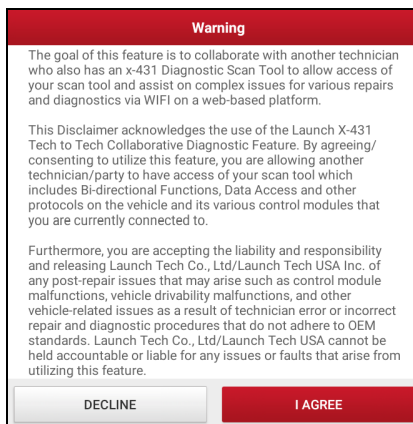

Tap **I AGREE** to enter the Contacts page. The following screen will appear.

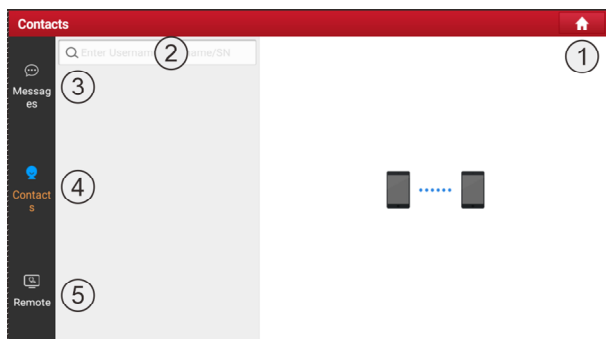

1	Home button	Tap it to navigate to the Job menu screen.
2	Search bar	Directly input the registered username of the tool to start searching, and then tap the desired one to add it into your Contacts list.

3	Message tab	If an incoming message reaches, a red dot will appear on the upper right corner of the tab.
4	Contacts tab	Tap to enter the friend list. The screen appears blank by default.
5	Remote tab	<p>There are two modules available for remote operation.</p> <ol style="list-style-type: none"> Request remote help: If you need support, just use this option to invite a technician to perform a remote control on your tool. Remote help: Request to control the partner's device remotely to help him diagnose the vehicle.

1. If you cannot fix a touch vehicle problem and want to seek a trusted second opinion or additional expertise from other technicians, refer to Chapter 5.3.2.1.
2. If you can provide the professional repair help, refer to Chapter 5.3.2.2.

Whatever you request remote help or provide remote help, the partner must be the users who have registered their Launch's diagnostic tools. They may be the following:

- Workshop
- Technician
- golo users

The display tablet is allowed to launch remote diagnosis with other diagnostic tools (including but not limited to the X-431 Torque Link) of Launch family, which are equipped with this module.

5.3.2.1 Request remote help

 Note: Before performing this operation, please make sure the following are met:

- Turn on the vehicle power supply.
- The tablet should be properly connected to the vehicle's DLC and a successful communication is required.
- In process of remote diagnosis, please note the following things:

- You are not suggested to execute any actions.
- The partner is not allowed to save any diagnostic reports or records on your tablet.
- Once you received the report from the partner, tap **View Report** to view details. All diagnostic reports are saved under the **Remote Reports** tab of **Report** on the Job Menu screen.

There are 4 ways available for requesting remote help:

- **Via “Contacts”**

Tap **Contacts**. Input the partner’s user name and tap **Search**, the following screen will appear:

 Note: If the partner is added into the Contacts, directly tap it to enter the instant messaging screen.

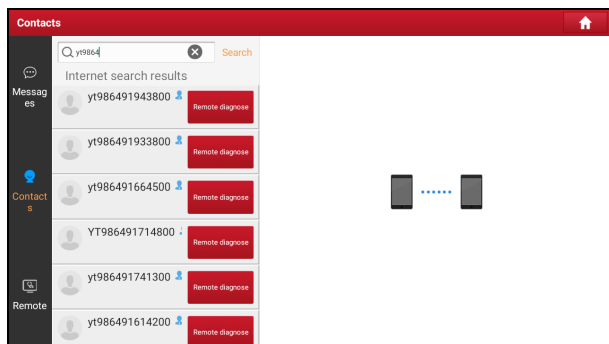

Method 1: Tap the target partner’s avatar, the following screen will appear:

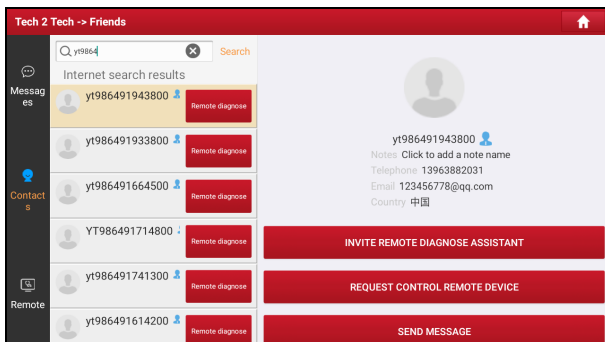

Tap **Invite Remote Diagnose Assistant**, choose the desired vehicle model and wait for the partner's confirmation.

Method 2: Tap **Remote Diagnose**, the following screen will appear:

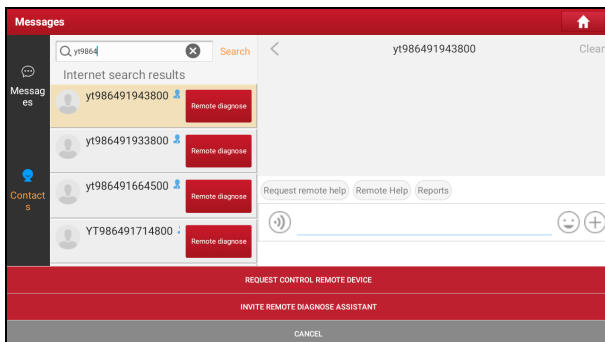



Tap **Invite Remote Diagnose Assistant**, choose the desired vehicle model and wait for the partner's confirmation.

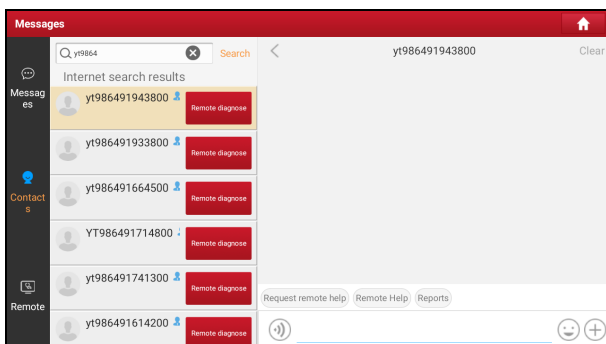

Method 3: Tap the target user name to enter the instant messaging mode. The following screen will appear:

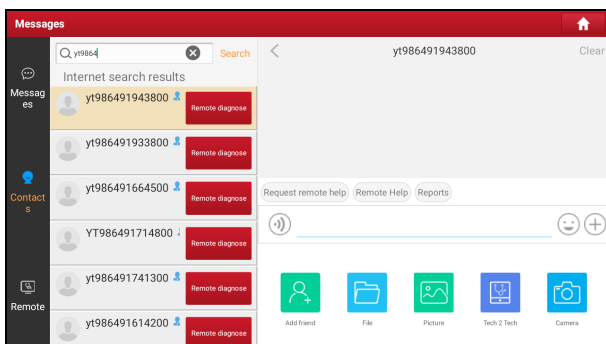

Tap  to call out more function options.



 Note: Here the following operations are available:

- Tap  to send the voice message. Tap  to send the emoji.
- Add friend: Add it into the Contacts list. After the partner receives the request, a beep will sound. After the partner agreed your request, he/she will automatically be listed in the Contacts tab.
- File: Choose diagnostic reports or local files to send.
- Picture: Choose screenshots or pictures to send.
- Tech to Tech: Start a remote diagnostic session.
- Camera: Open camera to take pictures.

Tap **Tech 2 Tech**, the following options will appear:

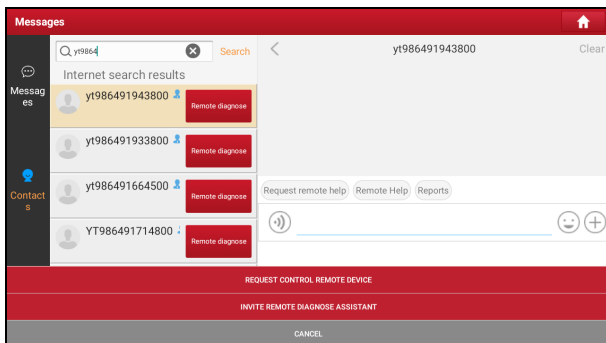

Tap **Invite Remote Diagnose Assistant**, choose the desired vehicle model and wait for the partner's confirmation.

- **Via "Remote"**

Method 4: Tap **Remote** to either the following screen.

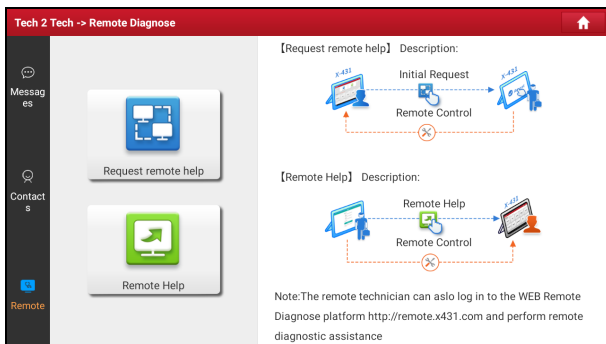

Tap **Request remote help**, the following screen will appear:

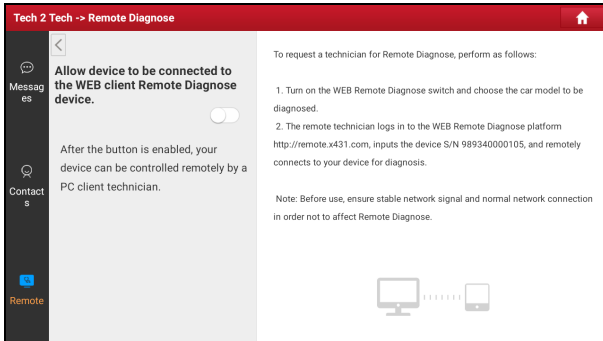

Slide the switch *Allow device to be connected to the WEB client remote diagnostic device* to ON so that the partner can find and connect to this device.

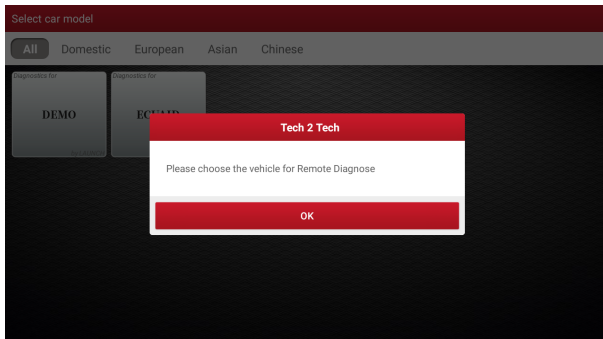

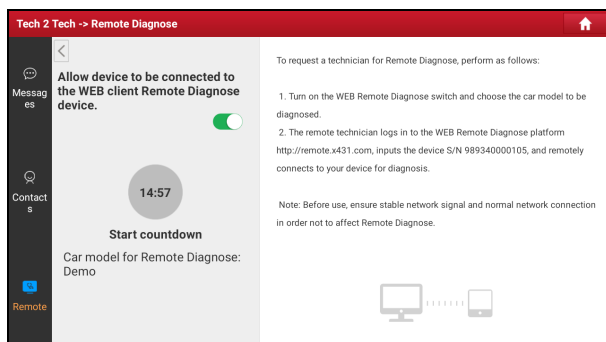

Choose the desired vehicle model and wait for the partner's confirmation.



Notify the partner of your device Serial Number and wait for receiving the remote help.

5.3.2.2 Provide remote help

 Notes:

- Before performing this operation, please make sure that you have registered the Launch's diagnostic tool.
- Remote diagnosis has the same diagnostic steps as manual diagnosis.
- In process of remote diagnosis, tap the  button to send a voice message.
- Once vehicle diagnosis is complete, a report will be created. Input your comments on this report, and then tap **Send Report** to send it to the partner.

There are 4 ways available for providing remote help.

- **Via "Contacts"**

Tap **Contacts**. Input the partner's user name and tap **Search**, the following screen will appear:

 Note: If the partner is added into the Contacts, directly tap it to enter the instant messaging screen.

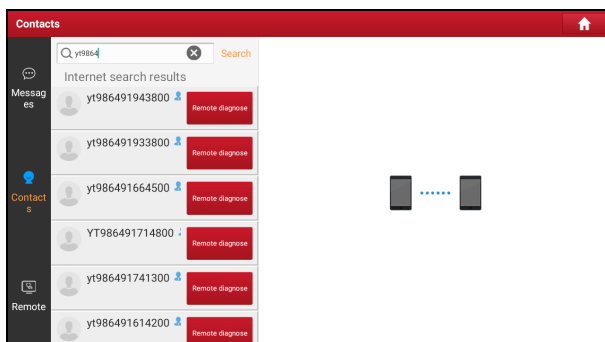

Method 1:

Tap the target partner's avatar, the following screen will appear:

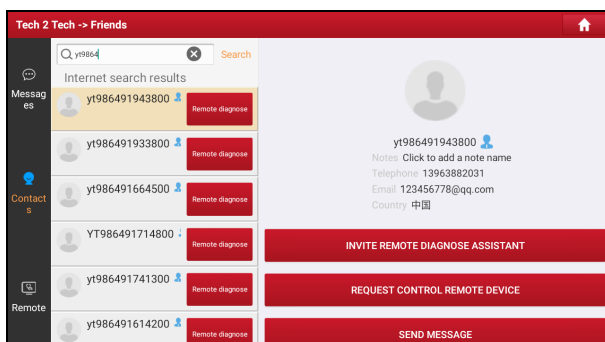

Tap **Request Control Remote Device** to launch the remote help. After the partner accepts the request, the remote diagnosis is ready to start.

Method 2:

Tap **Remote Diagnose**, the following screen will appear:

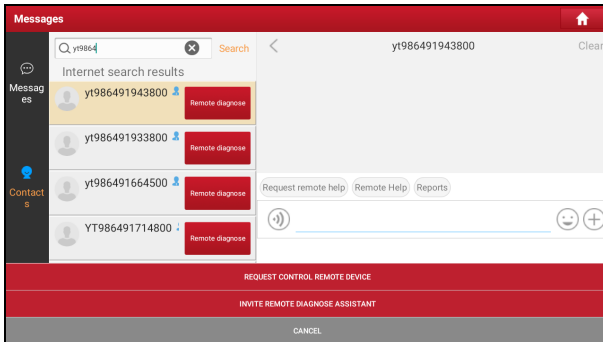

Tap **Request Control Remote Device** to launch the remote help. After the partner accepts the request, the remote diagnosis is ready to start.

Method 3:

Tap the target user name to enter the instant messaging mode. The following screen will appear:

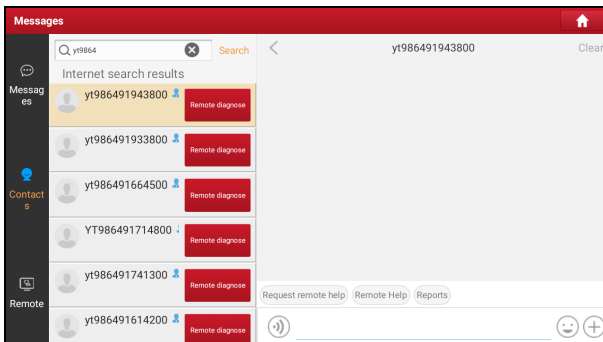

Tap **+** to call out more function options.

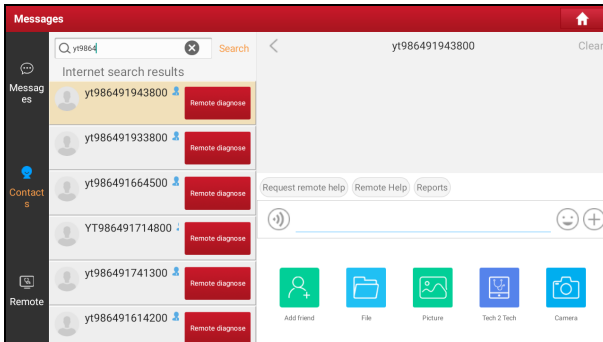

Tap **Tech 2 Tech**, the following options will appear:

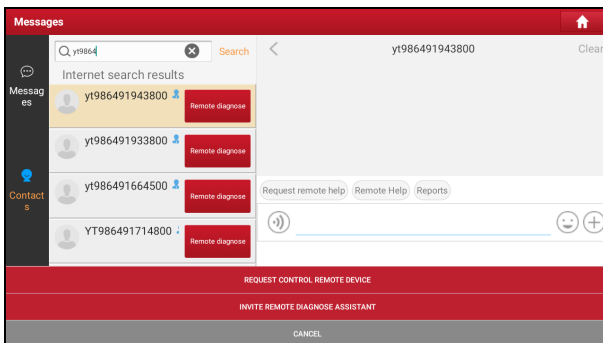

Tap **Request Control Remote Device** to launch the remote help. After the partner accepts the request, the remote diagnosis is ready to start.

- **Via “Remote”**

Method 4:

Tap **Remote** to ether the following screen.

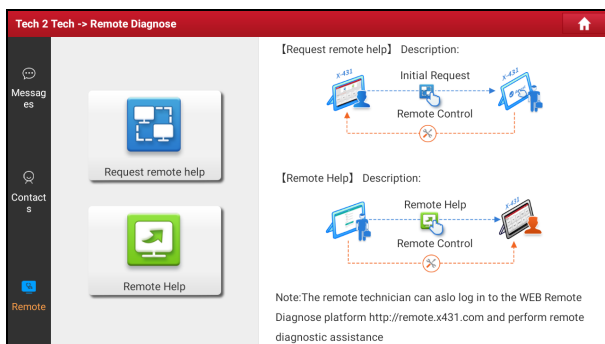

Tap **Remote help**, it will automatically navigate to the real-time remote full system diagnosis platform.

 Note: Alternatively, you can also use a PC to access the website <http://remote.x431.com/cn/> to login the remote full system diagnosis platform if no LAUNCH diagnostic tool keeps attended.

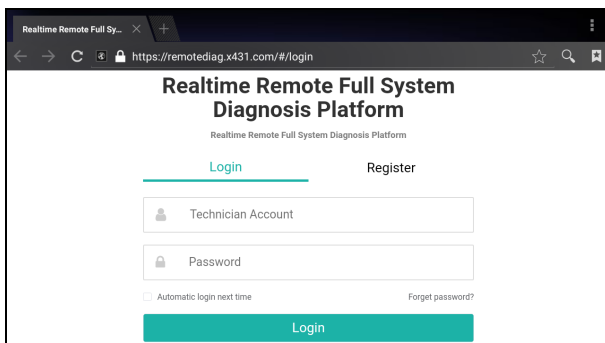

Input the correct technician account and password, and tap **Login**. The following screen will appear:

 Note: The technician account may be either a registered username of the LAUNCH diagnostic tool or a golo technician account.

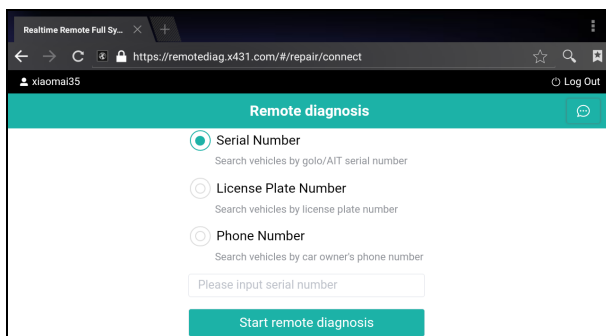

Check the box *Series Number* and enter the Serial Number provided by the remote help requester, and then tap **Start remote diagnosis** to start the remote help.

The operations in remote diagnosis are same as those in local diagnosis. Once the session is complete, a remote diagnostic report will be automatically generated.

5.4 Diagnostic History

Generally once a vehicle diagnosis is performed, the tablet will record the every details of diagnostic process. The History function provides direct access to the previously tested vehicles and users can resume from the last operation, without starting from scratch.

Tap **History** on the Diagnose main menu screen, all diagnostic records will be listed on the screen in date sequence.

- Tap certain vehicle model to view the details of the last diagnostic report.
- To delete certain diagnostic history, select it and then tap **Delete**. To delete all historical records, tap **Select All** and then tap **Delete**.
- Tap **Quick access** to directly navigate to the function selection page of last diagnostic operation. Choose the desired option to proceed.

6 Diagnostic Feedback

This item allows you to feedback your diagnostic problems to us for analysis and troubleshooting.

Tap **Diag Feedback**, a pop-up message will appear:

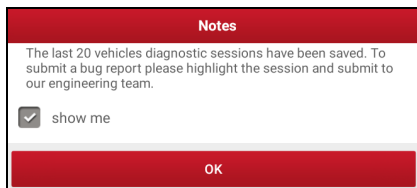

Tap **OK**, the following 3 options will be displayed on the left column of the screen.

A. Feedback

Tap certain tested vehicle model to enter the feedback screen.

- 1) Tap **Choose File** to open the target folder and choose the desired diagnostic logs.
- 2) Choose the failure type and fill in the detailed failure description in the blank text box and telephone or email address. After inputting, tap **Submit Result** to send it to us.

B. History

Tap it to view all diagnostic feedback records. Different process states are marked with different colors.

C. Offline list

Tap it to display all diagnostic feedback logs which have not been submitted successfully due to network failure. Once the handset gets a stable network signal, it will be uploaded to the remote server automatically.

7 I/M Readiness

An important part of a vehicle's OBD II system is the Readiness Monitors, which are indicators used to find out if all of the emissions components have been evaluated by the OBD II system. They are running periodic tests on specific systems and components to ensure that they are performing within allowable limits.

Currently, there are eleven OBD II Readiness Monitors (or I/M Monitors) defined by the U.S. Environmental Protection Agency (EPA). Not all monitors are supported in every vehicles and the exact number of monitors in any vehicle depends on the motor vehicle manufacturer's emissions control strategy.

Continuous Monitors -- Some of the vehicle components or systems are continuously tested by the vehicle's OBD II system, while others are tested only under specific vehicle operating conditions. The continuously monitored components listed below are always ready:

- 1) Misfire
- 2) Fuel System
- 3) Comprehensive Components (CCM)

Once the vehicle is running, the OBD II system is continuously checking the above components, monitoring key engine sensors, watching for engine misfire, and monitoring fuel demands.

Non-Continuous Monitors -- Unlike the continuous monitors, many emissions and engine system components require the vehicle to be operated under specific conditions before the monitor is ready. These monitors are termed non-continuous monitors and are listed below:

- 1) EGR System
- 2) O₂ Sensors
- 3) Catalyst
- 4) Evaporative System
- 5) O₂ Sensor Heater
- 6) Secondary air Injection

7) Heated Catalyst

8) A/C system

I/M refers to Inspection and Maintenance that is legislated by the Government to meet federal clean-air standards. I/M Readiness indicates whether or not the various emissions-related systems on the vehicle are operating properly and are ready for Inspection and Maintenance testing.

The purpose of the I/M Readiness Monitor Status is to indicate which of the vehicle's Monitors have run and completed their diagnosis and testing, and which ones have not yet run and completed testing and diagnosis of their designated sections of the vehicle's emissions system.

The I/M Readiness Monitor Status function also can be used (after repair of a fault has been performed) to confirm that the repair has been performed correctly, and/or to check for Monitor Run Status.

Tap **I/M Readiness** on the Job Menu to start checking the readiness.

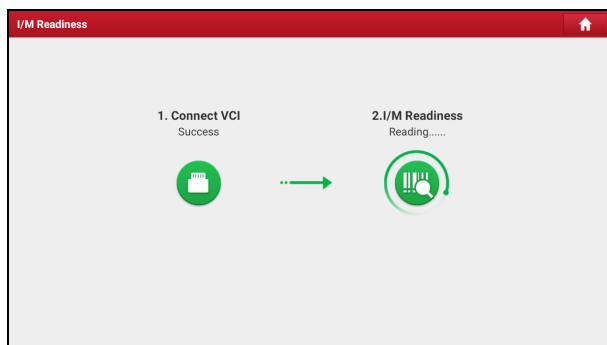



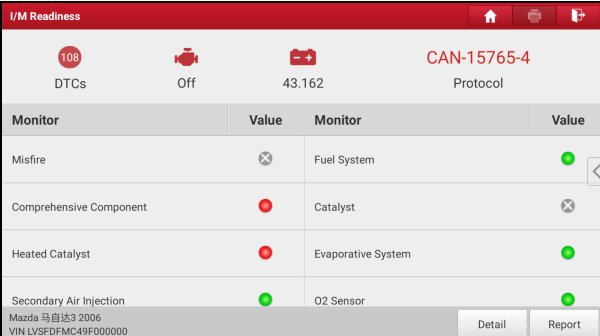

After checking all I/M readiness status, the screen will output the result:



I/M Readiness			
108 DTCs	Off	43.162	CAN-15765-4 Protocol
Monitor	Value	Monitor	Value
Misfire	⊗	Fuel System	●
Comprehensive Component	●	Catalyst	⊗
Heated Catalyst	●	Evaporative System	●
Secondary Air Injection	●	O2 Sensor	●

Mazda 马自达3 2006
VIN LV5SDFMC49F000000

Detail Report

 Note:  means not available on this vehicle,  means incomplete or not ready,  means Completed or Monitor Ok.

8 Reports

This option is used to view, delete or share the saved reports.

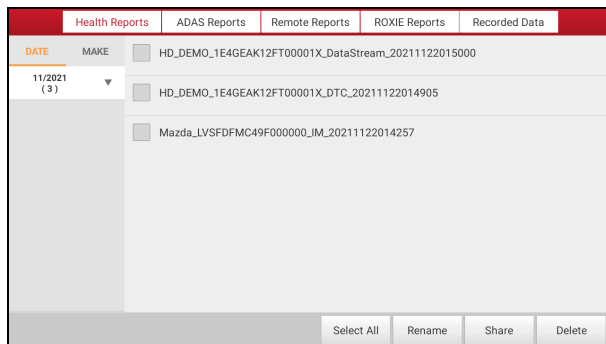

1. Health Reports

This module stores all diagnostic reports generated in process of vehicle diagnosis.

All diagnostic reports are sorted by Date and Make. Tap the desired type to re-arrange and filter it.

- To select certain report, check the box before the report. To select all reports, tap **Select All**. To deselect all, tap **Unselect**.
- To change the filename of report, tap **Rename**.
- To share the report with others, select the desired one and then tap **Share**.
- Select the desired report and then tap **Delete** to delete it.

2. ADAS Reports

This option lists all diagnostic reports saved in process of ADAS calibration operations.

3. Remote Reports

This option lists all diagnostic reports generated in process of Tech 2 Tech remote diagnostics.

4. ROXIE Reports





This option stores all vehicle inspection reports generated by the ROXIE W device that has been bound to the tool.

5. Recorded Data



If user records the running parameters or waveform graphs while reading data stream, it will be saved as diagnostic records and appear under this tab.

Tap **Recorded Data**, and select certain diagnostic record to enter.

Select the desired data stream items and tap **OK** to navigate to the playback page.

Diagnostic Record			
Name	Value	English	Metric
Anti-theft Status	—		
Barometric air pressure	141.52	psi	
Barometric air pressure sensor signal voltage	28.92	V	
Battery voltage	28.92	V	
J1939 stop broadcast source address one	(1 / 1) 62464	count	

Auto Playback(x1) 0/28 FRAME PLAYBACK

 Graph
 Combine
 Value

On-screen Buttons:

Graph: Displays the parameters in waveform graphs.

Combine: This option is mostly used in graph merge status for data comparison. In this case, different items are marked in different colors.

Value: This is the default mode which displays the parameters in texts and shows in list format.

Frame Playback: Plays back the recorded data stream items frame by frame. Once it is in frame playback mode, this button changes into **Auto Playback**.

9 Software Update

This module enables you to update the diagnostic software & App and frequently used software.

9.1 Update Diagnostic Software & APP

Go to **Software Update** on the Job Menu and tap the **Downloaded** tab.

The **Available** tab displays a list of software that can be updated. Under it, all software is categorized into three kinds:

- **Common software:** mainly includes some common apps that are associated with the diagnostic app. The software of this kind always stays at the top of the list, which can be deselected manually (excluding the system app, such as firmware and ECU aid).
 - **Frequently used vehicle software:** refers to the diagnostic software that is frequently used, including the vehicle diagnostic software and Reset software. It is generally displayed following the **Common software** list.
 - **Other vehicle software:** refers to the diagnostic software that is rarely used or never used. It is generally displayed following the **Frequently used software** list.
- 1). If the user does not download any diagnostic software during the sign-up process, all diagnostic software is selected by default. Tap **Update** to start downloading.
 - 2). If the user downloaded all/some vehicle software during the sign-up process and had it serviced for a long period of time, only the frequently used software is selected. Tap **Update** to start downloading. Other vehicle software that is rarely used will also be listed under the **Available** tab, but it is not selected at default.

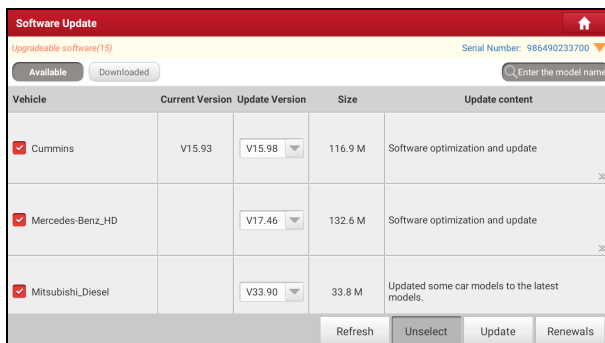

To download certain software that is not frequently used, check the box before the vehicle model. Tap **Update** to start downloading.

Once download is finished, the software packages will be installed automatically.

9.2 Update Frequently Used software

If the user only intends to update the frequently used software, go to **Software Update** and tap the **Downloaded** tab.

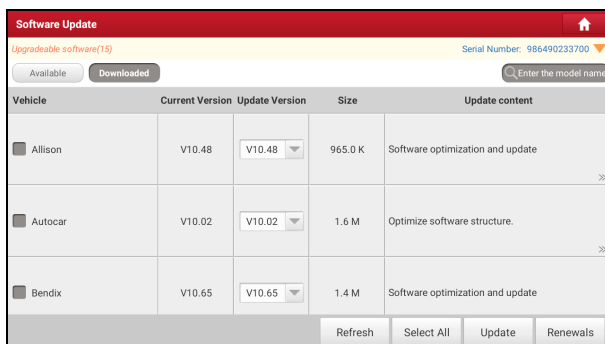

Tap **Update** to start downloading. Once download is finished, the software packages will be installed automatically.

9.3 Renew Subscription

If the software subscription is due or expires, the system will prompt you to renew your subscription.

Tap **Renewal** on the bottom of the screen to go to the **Mail** to make payment.

10 Profile

This function allows users to manage personal information and VCI etc.

10.1 VCI Management

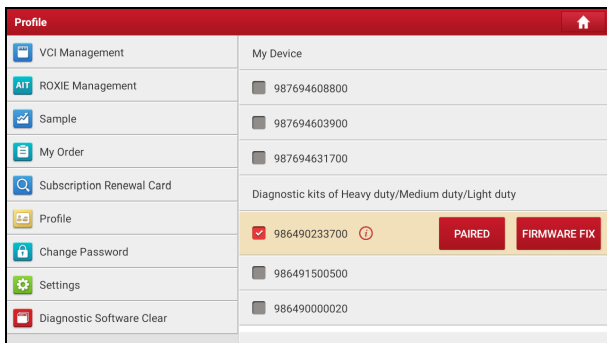

If several VCI devices are activated on this tool, a list of VCI devices will be displayed on the screen.

Once you choose the device that belongs to other account, you have to log out, and then input the right account to continue.

- If you use another VCI to test a vehicle, select the desired checkbox and tap **Pair** to pair it with the tablet.
- If the current VCI comes across communication failure, tap **Firmware Fix** to update and fix the diagnostic firmware. During fixing, please do not cut power or switch to other interfaces.
- If you use the current account to test a vehicle with another tablet, tap **Paired** to unpair the VCI device with the previously paired tablet.
- If you bought a new VCI device or skipped the Activate VCI step in process of sign-up, tap **Activate VCI** to activate it.

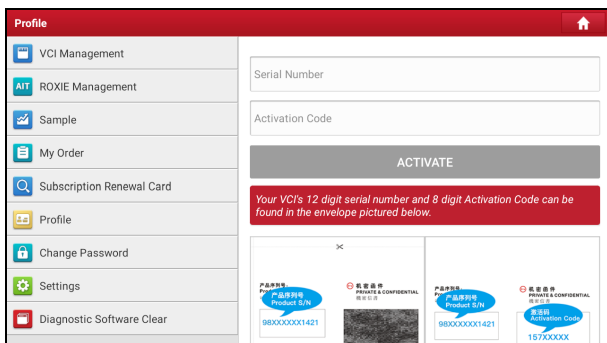

Input the Serial Number and Activation Code (can be found from the included Password Envelope), and then tap **Activate** to activate it.

 Note: please be sure to keep the VCI powered on while performing the operation.

10.2 ROXIE Management

This option is used to activate and bind the ROXIE W device to the tool. Once bound, the reports generated by the ROXIE W device will be automatically pushed to the tool each time the inspection session is finished.

Tap **ROXIE Management**, the following screen will appear:

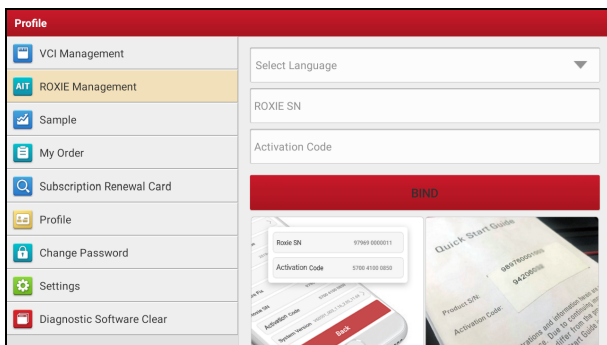

Fill in the ROXIE W S/N and Activation Code (can be found in the Settings on the Job Menu), then tap **Bind**.

10.3 Sample

This feature allows you to manage the recorded data stream sample files.

10.4 My Order

This item allows you to check the status of all your orders.

10.5 Subscription Renewal Card

This item is used to check the status of the subscription renewal card.

Input the 12-digit subscription renewal card number. Tap **Search** to get the search result.

10.6 Profile

Use this item to view and configure personal information.

10.7 Change Password

This item allows you to modify your login password.

10.8 Settings

10.8.1 General

1). Units

It is designed to set the measurement unit. Metric System and English System are available.

2). Diagnostic Software Auto Update

This option is designed to turn on/off the automatic diagnostic software update function. If set as ON, the system will automatically update the available diagnostic software when the tablet has a network connection and a newer version is detected.

3). Automatic detection once connected

This option enables you to determine whether to start an automatic VIN

detection once the tablet is properly connected to the vehicle's DLC.

4). Auto Generate Health Report once connected

Once it is set as ON, the system will automatically output a health report once the AutoDetect diagnostic session is finished.

10.8.2 Shop Information

This option lets you define your print information. It mainly includes Workshop, Address, Zip Code, Telephone, Email etc.

Settings	
General	Shop Name shopbcvbgd
Shop Information	Address line1 avdfdvdf
Printer Set	Address line2 svvffvs
Clear Cache	Country United States >
Log Out	County / Region state
	City city
	Zip Code zipcode
	Telephone 1812655566

After inputting, tap **SAVE**.

Once you saved the print information, it will be entered automatically in the *More Information* box every time you save the diagnostic report.

10.8.3 Printer Set

This option is designed to establish a wireless connection between the tablet and the Wi-Fi printer (sold separately) while performing printing operations.

The App is compatible with the *LAUNCH Wi-Fi Printer* (sold separately) and *System* (external printer).

For LAUNCH Wi-Fi mini printer, follow the instructions described in the user manual included with the Wi-Fi mini printer to configure it.

For other Wi-Fi printers,

Before printing, make sure the following conditions are met:

- The Wi-Fi printer is powered on and working normally.
- The print service plug-in associated with the printer is already installed on the tablet (Go to Google Play or use the Browser to download and install it).

Follow the steps below to proceed:

1. Set the default printer as **System**.
2. Go to **Settings -> Network & Internet -> WLAN**, set the WLAN switch to Off.
3. On the report details page, tap .

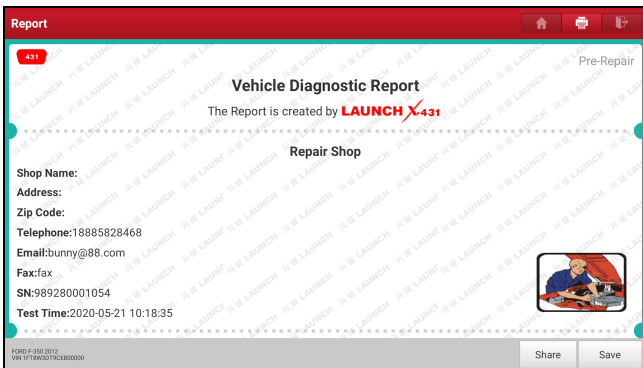

4. Touch  next to **Select a printer** on the upper left corner of the screen.

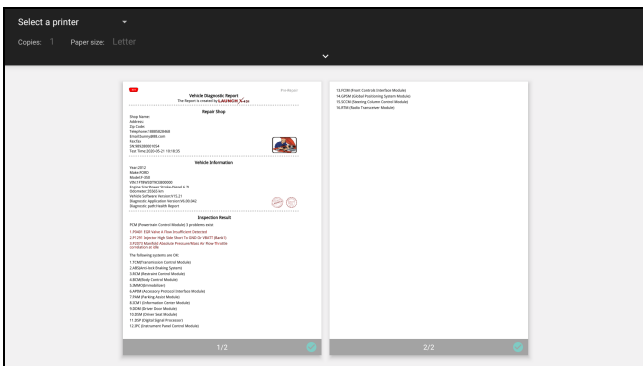

5. Select **All Printers -> Add printer** and enable the installed printer service, the system starts searching for all available Wi-Fi printers of the brand.

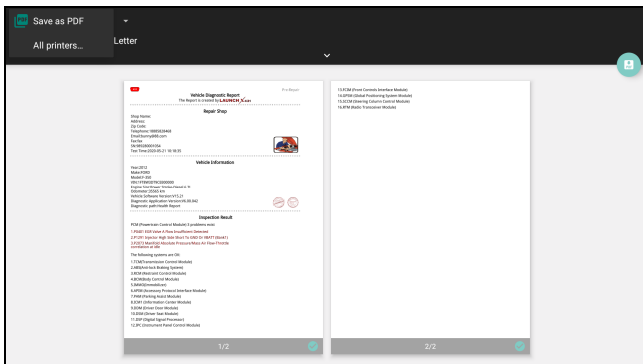

6. Select the desired Wi-Fi printer from the list. If the chosen Wi-Fi printer hotspot is open, the tablet can connect it directly. If it is encrypted, a password may be required. Refer to the Wi-Fi printer user manual to get the default password.
7. Now the printer is ready for printing.
8. Alternatively, you can also choose **Save as PDF** to save the current diagnostic report as a PDF file for later printing.

10.8.4 Clear Cache

This option allows you to clear the App cache. Clearing the cache will restart the App.

10.8.5 Login/Logout

To logout the current user ID, tap **Logout**.

To login the system again, tap **Login**.

10.9 Diagnostic Software Clear

This item allows you to hide/clear the diagnostic software that is not frequently used.

Tap **Diagnostic Software Clear** to enter.

Under the **Hide Software** tab, select the desired diagnostic software and tap **Hide**, it will become invisible. Tap **Unhide** to undo the hide operation.

Under the **Remove Software** tab, select the desired diagnostic software and tap **Delete**, it will disappear from the screen.

*Note: Removing software may completely delete the software from the tablet. If some software is not used and the tablet runs out of space, please use this feature to remove it. To re-download it, go to **Software Update -> Available**.

11 Add-on Modules

11.1 TPMS

This module allows you to configure the tablet as TPMS activation & diagnostic tool, which provides the ability to trigger TPMS sensor, program TPMS sensor, perform the relearning procedure. It needs to work with the compatible TSGUN device (sold separately).

For more details, please refer to the User Manual included with the module.

11.2 ADAS (Calibration)

This module enables you to effectively and accurately calibrate a wide range of camera-based & radar-based driver assistance systems, e.g. the front camera for the lane departure warning system, the radar sensor for the ACC (Adaptive Cruise Control) or the camera for adaptive headlights. It needs to work with the specific ADAS calibration tool (sold separately).

For more details, please refer to the User Manual included with the module.

11.3 Videoscope

This module allows you to check those unseen parts of engine, fuel tank, braking system. It needs to work with the compatible Videoscope device (sold separately).

For more details, please refer to the User Manual included with the module.

11.4 BST360 (Battery Tester)

This module allows you to fix battery detection faster and easier. It needs to work with the specific Bluetooth battery tester (sold separately).

For more details, please refer to the User Manual included with the module.

11.5 Immobilizer Programmer

This module allows you to perform the read-write function for vehicle keys,

EEPROM, MCU, and EEPROM/FLASH of vehicle engine and gearbox ECU. It needs to work with the specific immobilizer programmer (sold separately).

For more details, please refer to the User Manual included with the module.

11.6 Mail

This module allows you to subscribe some extra software or service functions that are not included in the diagnostic tool online.

9 Synchronization

You can transfer media files, screenshots and APK between the PC and tablet.

1. Connect one end of the included charging/data cable to the charging/data I/O port of the tablet, and the other end to the USB port of the PC.
2. Swipe the tablet screen from the top, a pull-down option list will appear on the screen.

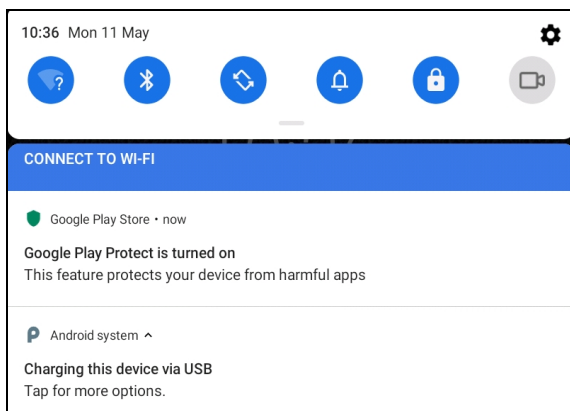

3. Tap **Charging this device via USB**, the following setting options will be displayed on the screen.

12 FAQ

1. How to save power?

- Please turn off the screen while the tool keeps idle.
- Set a shorter standby time.
- Decrease the brightness of the screen.
- If WLAN connection is not required, please turn it off.

2. Communication error with vehicle ECU?

Please confirm:

1. Whether the VCI is correctly connected.
2. Whether ignition switch is ON.
3. If all checks are normal, send vehicle year, make, model and VIN number to us using Feedback feature.

3. Failed to enter into vehicle ECU system?

Please confirm:

1. Whether the vehicle is equipped with this system.
2. Whether the VCI is correctly connected.
3. Whether ignition switch is ON.
4. If all checks are normal, send vehicle year, make, model and VIN number to us using Feedback feature.

4. How to reset the tablet?

 Resetting may cause data loss. Before doing so, please make sure important data and information has been backed up.

Do the following to reset the tablet:

1. Tap **Settings -> System -> Reset options**.
2. Tap **Erase all data (factory reset)**.
3. Tap **RESET TABLET**.
4. Tap **ERASE EVERYTHING** to start resetting until the tool automatically

reboots.

5. What to do if the language of vehicle diagnostic software does not match the system language?

English is the default system language of the tool. After the system language is set to the preference language, please go to the update center to download the vehicle diagnostic software of the corresponding language.

If the downloaded diagnostic software is still displayed in English, it indicates that the software of the current language is under development.

6. How to retrieve the login password?

Please follow below steps to proceed in case you forgot the login password:

1. Tap the application icon on the home screen to launch it.
2. Tap the **Login** button on the upper right corner of the screen.
3. Tap **Retrieve password**.
4. Input product S/N and follow the on-screen prompts to retrieve the password.

Warranty

THIS WARRANTY IS EXPRESSLY LIMITED TO PERSONS WHO PURCHASE LAUNCH PRODUCTS FOR PURPOSES OF RESALE OR USE IN THE ORDINARY COURSE OF THE BUYER'S BUSINESS.

LAUNCH electronic product is warranted against defects in materials and workmanship for one year from date of delivery to the user.

This warranty does not cover any part that has been abused, altered, used for a purpose other than for which it was intended, or used in a manner inconsistent with instructions regarding use. The exclusive remedy for any automotive meter found to be defective is repair or replacement, and LAUNCH shall not be liable for any consequential or incidental damages.

Final determination of defects shall be made by LAUNCH in accordance with procedures established by LAUNCH. No agent, employee, or representative of LAUNCH has any authority to bind LAUNCH to any affirmation, representation, or warranty concerning LAUNCH automotive meters, except as stated herein.

Disclaimer

The above warranty is in lieu of any other warranty, expressed or implied, including any warranty of merchantability or fitness for a particular purpose.

Purchase Order

Replaceable and optional parts can be ordered directly from your LAUNCH authorized tool supplier. Your order should include the following information:

- Order quantity
- Part number
- Part name

Customer Service

If you have any questions or comments please forward them to:

LAUNCH Tech USA

Product Support

Phone: 877-528-6249 xt: 4

E-mail: support@launchtechusa.com

Fax: 562-463-1590

Monday - Friday 5 am - 5 pm PST

Service & Repair

Phone: 877-528-6249 xt: 5

Monday - Friday 8 am - 5 pm PST

If your unit requires repair service, return it to the manufacturer with a copy of the sales receipt and a note describing the problem. If the unit is determined to be in warranty, it will be repaired or replaced at no charge. If the unit is determined to be out of warranty, it will be repaired for a nominal service charge plus return freight. Send the unit pre-paid to:

Attn: LAUNCH Tech USA

1820 South Milliken Ave.

Ontario, CA 91761