



## TTCF-9B

### Cooler Line Flusher



## Operations Manual

# TABLE OF CONTENTS

<b>INTRODUCTION TO THE MACHINE .....</b>	<b>2</b>
<b>CUSTOMER SERVICE CONTACT INFO .....</b>	<b>2</b>
<b>SAFETY INFORMATION .....</b>	<b>3</b>
<b>MACHINE SPECIFICATIONS &amp; FEATURES .....</b>	<b>9</b>
<b>MACHINE OVERVIEW .....</b>	<b>10</b>
<b>OPERATING INSTRUCTIONS .....</b>	<b>11</b>
<b>MAINTENANCE .....</b>	<b>15</b>
<b>REPLACEMENT PARTS .....</b>	<b>16</b>
<b>WARRANTY INFORMATION .....</b>	<b>19</b>

# INTRODUCTION

Congratulations on the purchase of your TTCF-9B Cooler Line Flusher. The TTCF-9B provides 8 GPM flow rate for heavy duty applications.

The Flo-Dynamics TTCF-9B Base Unit High Flow Hydraulic System Flusher will flush and clean transmission coolers and lines or any hydraulic system of contamination, sludge and varnish deposits, and particles from a failed transmission.

The TTCF-9B has a flow rate of 8 GPM to clean heavy duty transmission cooling systems requiring high flow rates. Using the same hydraulic fluid as the hydraulic system being flushed and cleaned, select from two preset air injected scrubbing action flush patterns, or perform a manual flush. Check system cleanliness with the reusable 60-micron screen filter.

The TTCF-9B has a preset heater that heats to 140°F in 45 minutes. Two manually selected flush patterns designed to inject the optimal amount of air creating an agitating scrubbing action to remove trapped debris and solidified waxy varnish.

Easily switch flow direction without removing service hoses during and between flush cycles with the reverser valve. Flush with or without heat with using separately controlled motor/pump and heater switches. PATENT PENDING.

**Please take time to read through this manual to familiarize yourself with the machine before performing your first component or transmission cooler and line flush.**

## CUSTOMER SERVICE CONTACT INFORMATION

For product information and tech support please call: **800-303-5874**  
or visit: **[www.flodynamics.com](http://www.flodynamics.com)**

# IMPORTANT SAFETY NOTICE

For your safety, read this manual thoroughly before operating this machine. This machine is intended for use by properly trained, skilled professional automotive technicians. The safety messages presented below and throughout this user's manual are reminders to the operator to exercise care when using this unit. Before using this machine, always refer to and follow the safety messages and applicable service procedures provided by the manufacturer of the vehicle being serviced.

## • Read All Safety Instructions

Read, understand, and follow all safety messages and instructions in this manual. Safety messages in this section of the manual contain a signal word with a three-part message and, in some instances, an icon.

## • Signal Words

The signal word indicates the level of the hazard in a situation:

### **DANGER**

*Indicates an imminently hazardous situation which, if not avoided, will result in death or serious injury to the operator or to bystanders.*

### **WARNING**

*Indicates a potentially hazardous situation which, if not avoided, could result in death or serious injury to the operator or to bystanders.*

### **CAUTION**

*Indicates a potentially hazardous situation which, if not avoided, may result in moderate or minor injury to the operator or to bystanders.*

### **IMPORTANT**

*Indicates a situation which, if not avoided, may result in damage to the machine, or the vehicle being serviced.*

## • Safety Messages

Safety messages in this section contain three different type styles:

- Normal type states the hazard.
- **Bold type** states how to avoid the hazard.
- *Italic type* states the possible consequences of not avoiding the hazard.

## • Safety Symbols

A safety symbol, when present, gives a graphical description of the potential hazard, and how to avoid the hazard:



**Risk of Fire**



**Read Instructions Before Use**



**Risk of Explosion**



**Mandatory Eye Protection**



**Risk of Entanglement**



**Mandatory Protective Gloves**



**Dangerous Fumes**



**Mandatory Protective Clothing**



**Do Not Pull or Move**



**Risk of Burns**

# IMPORTANT SAFETY INSTRUCTIONS

## DANGER



Engine exhaust contains toxic gases.

- **Vent vehicle's exhaust away from work area.**
- **Do not breathe exhaust.**

*Exhaust gases will cause injury or death.*

## WARNING



Improper use and operation.

- **Read, understand and follow all safety messages and operational procedures in this manual before operating this machine.**
- **This equipment should be operated only by qualified personnel.**
- **Use this equipment only as described in this manual.**

*Improper use and operation of this product can result in injury.*

## WARNING



Engine systems can malfunction expelling fuel, oil vapors, hot steam, hot toxic exhaust gases and other flying particles.

- **Wear safety goggles and protective clothing, user and bystander. Everyday eyeglasses only have impact resistant lenses; they are NOT safety glasses.**
- **Do not position head directly over or in front of carburetor or throttle body. Engine backfire can occur when air cleaner is out of normal position.**
- **Make sure gauge reads zero before connecting or disconnecting hose connections to adapters.**
- **Make sure cooling system pressure has been relieved before connecting or disconnecting hose connections and adapters.**
- **Keep a dry chemical (Class B) fire extinguisher rated for gasoline, chemical & electric fires in the work area.**

*Fire, explosion, or flying particles may cause serious injury.*

## WARNING



Risk of expelling pressurized fluids.

- **Wear safety goggles and protective clothing, user, and bystander.**

- Engine systems can malfunction, expelling fuel, oil vapors, hot steam, hot toxic exhaust gases and other debris.
- Always unplug the machine from its power source when not in use.
- Keep the service hoses away from hot or moving engine parts. Hoses can split or burst causing fluid to be expelled.

- Avoid contact with engine coolant.

- Treatment methods are as follows:

**Eyes:** Flush eyes with plenty of water.

**Skin:** Wash with soap and water.

**Inhalation:** Move to uncontaminated area.

**Ingestion:** If large amount, get medical attention.

If any irritation persists, get medical attention.

- Dispose of used fluid according to environmental laws and regulations.

*Fuel, oil vapors, hot steam, hot toxic exhaust gases, pressurized fluid, and other debris can cause serious injury.*

## **WARNING**

Risk of unexpected vehicle movement.

- **Block drive wheels before starting vehicle's engine to begin an exchange.**
- **Unless instructed otherwise, set parking brake and put gear selector in park.**
- **Do not leave a running vehicle unattended.**
- **If vehicle has an automatic parking brake release, disconnect release mechanism for testing and reconnect when testing is completed.**

*A moving vehicle can cause injury.*

## **WARNING**



Risk of entanglement. Engine has moving parts.

- **Do not place tools on fenders or other places in engine compartment.**
- **Keep yourself, clothing, battery cables and service hoses clear of moving parts such as fan blades, belts, pulleys, hood and doors.**
- **Barriers are recommended to help identify danger zones in test area.**
- **Prevent personnel from walking through immediate test area.**

*Contact with moving parts can cause injury.*

## **WARNING**



Risk of fire or explosion.

- **Do not operate in the vicinity of open containers of flammable liquids such as gasoline.**
- **Keep hoses and jumper cables away from heat sources and sharp edges.**
- **Do not operate equipment with damaged cords or hoses until they have been examined by a qualified serviceman.**

*Fire or explosion can cause injury.*

## **WARNING**



Risk of fire or explosion. Gases produced by a battery are highly explosive.

- **Wear safety goggles and protective clothing, user and bystander.**
- **Do not smoke, place metal tools on battery or allow a spark or flame in vicinity of battery.**

*Battery explosion can cause injury.*

## **WARNING**



Risk of burns.

- **Wear gloves when handling hot engine components.**
- **Do not remove radiator cap unless engine is cold.**
- **Pressurized engine coolant may be hot.**
- **Do not touch hot exhaust systems, manifolds, engines, radiators, etc.**

*Hot fluid and engine parts may cause injury.*

## **WARNING**



Battery acid is a highly corrosive sulfuric acid.

- **Wear safety goggles and protective gloves, user and bystander.**
- **Have plenty of fresh water and soap nearby. If battery acid contacts skin, clothing, or eyes, flush exposed area with soap and water for 10 minutes.**
- **Do not touch eyes while working near battery.**

*Battery acid can burn eyes and skin.*

## **WARNING**



Risk of burns.

- **Wear gloves when working near hot engine components.**
- **Do not touch hot exhaust systems, manifolds, engines, radiators, etc.**
- **The fluid coming from the vehicle along with some of the machine's components that the fluid comes into direct contact with (i.e. hoses and fittings) may reach temperatures uncomfortable to the touch. Exercise caution in avoiding contact with these items.**

*Hot components can cause injury or discomfort.*



## CAUTION



Risk of injury.

- **This equipment should be operated by qualified personnel only.**
- **Use this equipment only as described in this manual.**
- **Always disconnect the machine from air source when not in use.**
- **Loop the pressure hose loosely in its proper location when machine is not in use.**
- **Do not operate equipment with a damaged hose, or if the equipment has been dropped or damaged, until it has been examined by a qualified service representative.**
- **Care should be taken to arrange the service hoses so that they will not be tripped over or pulled.**
- **Never pull on the service hoses to transport the machine. Damage may occur to these components, or machine may tip over.**
- **Keep area of operation clear of unnecessary tools and equipment. Utilize recessed tool storage areas on the top of the machine.**
- **Never leave the machine running unattended.**
- **This machine is not designed for any other purpose than the servicing of automotive cooling systems.**

*Operation of this machine by anyone other than qualified personnel may result in injury.*

## CAUTION

Misdiagnosis may lead to incorrect or improper repair and/or adjustment.

- **Do not rely on erratic, questionable, or obviously erroneous test information or results. If test information or results are erratic, questionable, or obviously erroneous, make sure that all connections and data entry information are correct and that the test procedure was performed correctly. If test information or results are still suspicious, do not use them for diagnosis.**

*Improper repair and/or adjustment may cause vehicle or equipment damage or unsafe operation.*

## IMPORTANT

Risk of equipment damage.

- **Servicing, transporting, or storing this machine in an attitude other than the normal operating position can result in fluid spillage and/or component damage.**
- **Never pull on the service hoses to transport the unit. Damage may occur to these components, or machine may tip over. Always use the handle to move.**
- **Periodically clean the machine by wiping down with a clean, soft, dry cloth.**

*Improper operation of equipment may result in damage to machine or components.*

**SAVE AND FOLLOW THESE INSTRUCTIONS!**

# MACHINE SPECIFICATIONS

**Dimensions:** 35L x 18W x 35H

**Weight:** 161 lbs.

**Power:** 20A or two separate 15A 110V circuits; 75-175 psi shop air

## FEATURES

- ✓ Powerful 3/4 HP motor
- ✓ Requires a dedicated 20-amp or two separate 15-amp circuits
- ✓ 13' heavy duty 3/4" service hoses
- ✓ 10-gallon transmission fluid capacity with easy to read level sight glass
- ✓ 8 GPM flow rate
- ✓ Low fluid heater cutoff float switch
- ✓ 60-micron cleanable screen filter with "T" handle simplifies verification of cleanliness
- ✓ Reverser valve allows easy flow reversal without changing service hoses during and between flush cycles
- ✓ Air purge to additionally agitate during flushing and to clear service lines and cooling system after flushing
- ✓ 1500-watt heater set at 140°F
- ✓ Temperature gauge
- ✓ Flush with or without heat
- ✓ Two non-bypass spin-on magnetic replaceable system filters (#40300272)
- ✓ Hour run meter
- ✓ 10" semi-pneumatic tires

## CONTROL PANEL FEATURES

One-touch control panel turns on heater, pump and selectable air-agitate patterns.

# MACHINE OVERVIEW

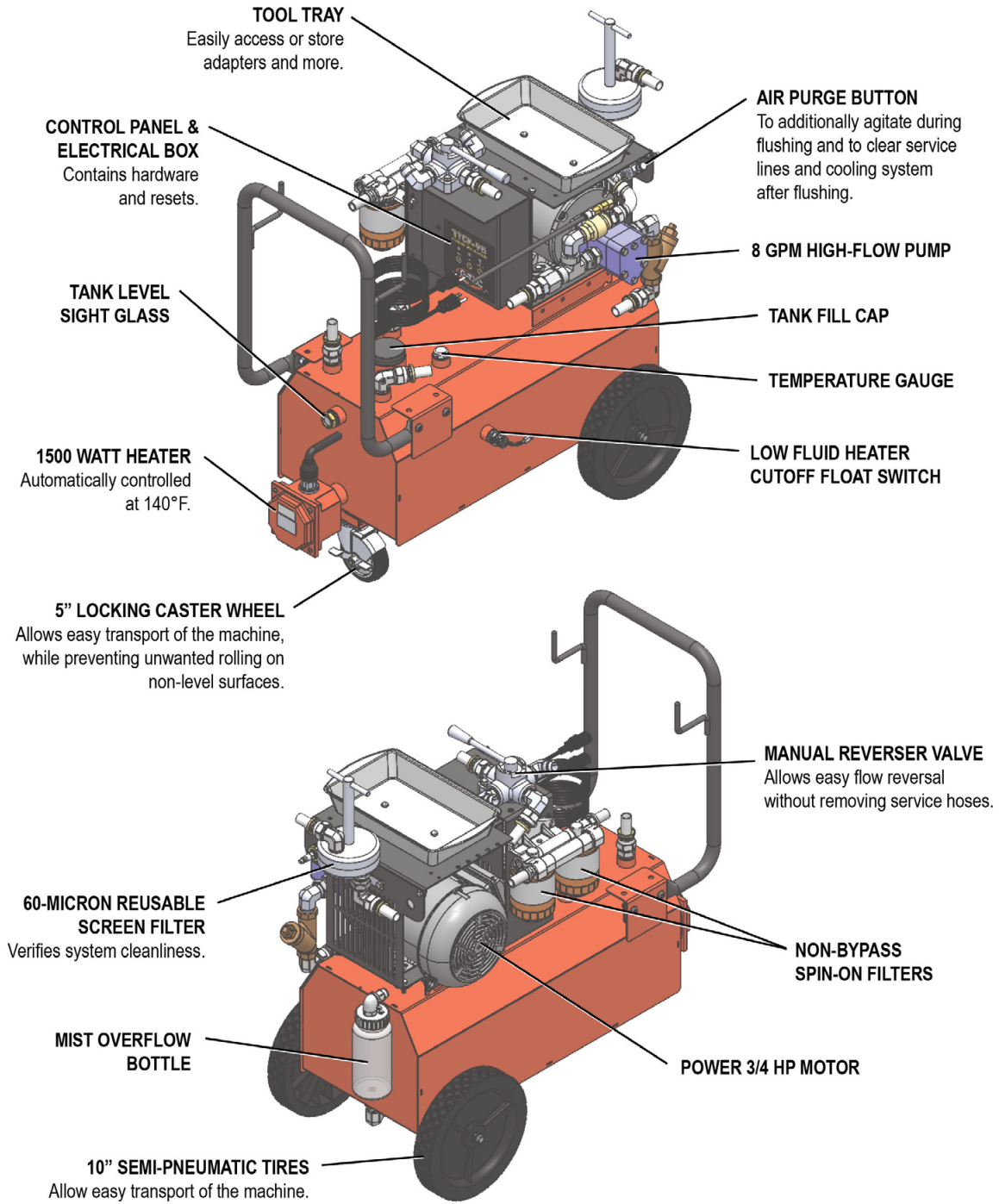

# OPERATING INSTRUCTIONS

## SAFETY RECOMMENDATIONS

This machine uses hot hydraulic fluid under pressure. Check the security of all hoses and connections before operation.

Only use the same hydraulic fluid as used in the hydraulic system being flushed. DO NOT use mineral spirits, solvents, or any other volatile liquid.

Always wear safety glasses, protective gloves, and proper clothing when operating the flusher.

If hydraulic fluid gets in your eyes or on your skin, rinse with water immediately and seek medical attention if needed.

**WARNING:** Improper use of this machine can result in burns and other serious injuries. Always wear eye protection and protective clothing and follow instructions to prevent potential injury.

## FLUSH PROCEDURE

Fill the tank with 10 gallons of hydraulic fluid or until fluid level is halfway in sight glass.

**WARNING:** DO NOT OVERFILL or run with fluid level higher than halfway in sight glass.

**CAUTION:** To prevent hydraulic fluid from overflowing during a flush cycle or when air purging, do not run with fluid higher than showing over halfway on the sight glass.

Plug the machine into a 20A grounded circuit without anything else plugged in or being used on the circuit. If a dedicated 20A circuit is not available, use two separate and dedicated 15A outlets.

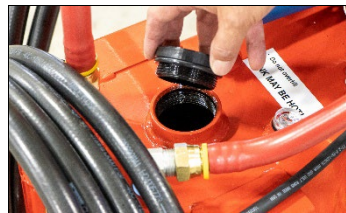

Connect the flusher to 100-125 PSI shop air.

Move the reverser valve to the bypass (middle) position.

**CAUTION:** Make sure the reverser valve is in the neutral/bypass position prior to preheating.

### PRIOR TO STARTING PREHEAT

- Secure fill cap
- Secure filter screen
- Check fluid level
- Check all connections
- Ensure the reverser valve is in the bypass (middle) position

Turn the Heater and Pump ON to begin heating the flusher while connecting the services hoses to the component or system being flushed.

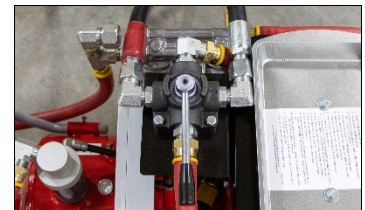

Connect the **red** banded service hose to the component or cooler Outlet line and the **black** service hose to the Inlet line of component or cooling system.

Once the unit reaches 135-140 degrees perform component or cooling system **Initial Purge** using the following steps:

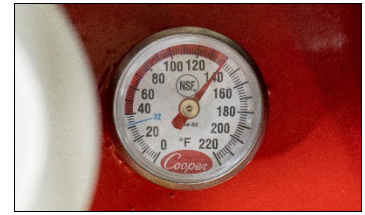

**NOTE:** To extend life of the flush tank fluid, it's always good to purge existing dirty fluid from component or cooling system prior to flushing. Follow initial purge procedure below.

#### INITIAL PURGE PRIOR TO FLUSHING

- Turn the motor/pump **OFF**.
- Remove the top half of the filter housing and place into a waste bucket/container.
- Move the reverser valve toward the red banded hose.

**CAUTION:** When purging, the fluid will be **HOT** with a high flow rate! Wear protective gloves, clothing and safety glasses and ensure top half of filter housing is held into waste container being used.

- Turn the pump **ON** and purge approximately 1-2 quarts of fluid or until cleaner fluid is observed.
- Turn motor/pump **OFF**.

Clean the screen filter if needed and reassemble the filter housing.

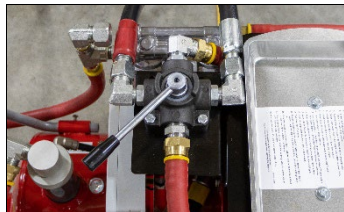

#### SETTING UP A FLUSH

With component or cooling system connected and initially flushed move the reverser valve toward the **red** banded hose connected to the component or cooler system outlet.

Select Air Agitation flush pattern by pressing the Air Agitate button.

- Red – Off, no air agitation
- Green – Low, single air pulse for low flow system
- Blue – High, two air pulses for high flow systems

**NOTE:** Air pulsing does not start until 1:30 minutes into flushing

Prior to starting flush:

- Secure fill cap
- Secure filter screen
- Check fluid level
- Check all connections

Turn motor/pump and heater **ON** to begin flushing.

Suggested to flush **initially** for 15 minutes.

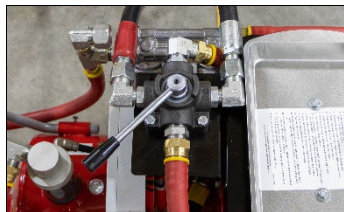

### When Initial 15 Minute Flush is Completed

Turn the pump **OFF**.

Press the **manual air purge** button to clear out the lines.

**NOTE:** Prior to removing the top portion of the screen filter housing, always use the manual air purge button to clear out the component or cooler system and service hoses.

Remove the top half of the filter housing, note any debris on the filter screen, clean the screen, and reassemble the filter housing.

Continue flushing, switching the flow direction between each flush using the reverser valve until there is no debris on the filter screen after flushing.

Depending on debris collected on filter screen after a flush it is suggested each flush be 30-60 minutes until cleanliness is achieved.

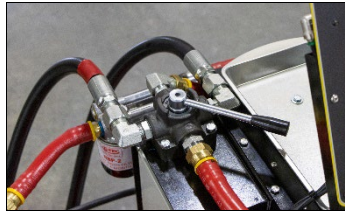
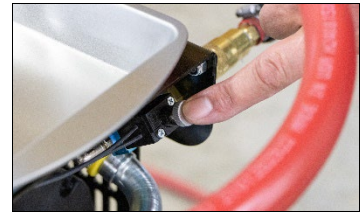

After system cleanliness is achieved and to disconnect flusher from system cleaned perform the following:

Use the manual air purge button to clean out the cooling system and service lines with the **reverser valve** in either flow direction, then place in **bypass** (middle) position.

Remove the service hoses from the system being cleaned and install service line plugs.

Clean the filter screen and reassemble for the next cleaning.

Unplug the flusher and disconnect shop air.

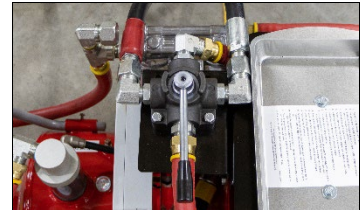
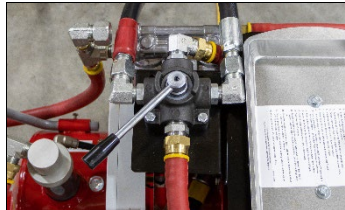

# ADDITIONAL FUNCTIONS

## FILL THE TANK

Remove the fill cap and add enough hydraulic fluid to bring the level to the middle of the sight glass.

**CAUTION:** To prevent hydraulic fluid from overflowing during a flush cycle or when air purging, do not run with fluid higher than showing over halfway on the sight glass.

Replace the fill cap when full level is reached.

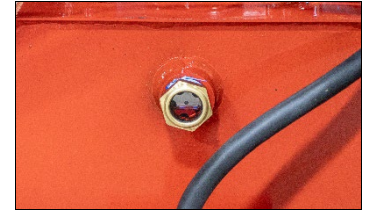
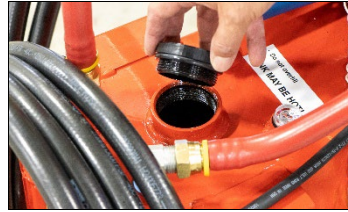

## DRAIN THE TANK USING THE MOTOR / PUMP

**CAUTION:** To prevent burns, only drain the system when fluid is below 100 degrees.

Ensure the heater is OFF.

Connect the drain hose adapter to the red banded service hose and place into a suitable waste container.

Move the reverser valve toward the red banded hose.

**CAUTION:** Fluid will drain at a high flow rate.

Turn the motor/pump ON and drain into waste container until the unit stops flowing.

Turn the motor/pump OFF.

**NOTE:** After draining, there is still approximately one gallon remaining in the tank. To completely drain, see "Completely Drain the Tank for Fluid Type Change" procedure below.

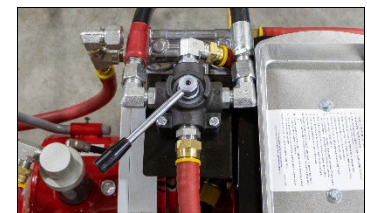
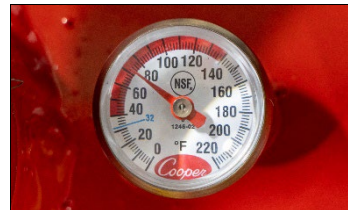

## COMPLETELY DRAIN THE TANK FOR FLUID TYPE CHANGE

Perform "Drain the Tank Using Motor/Pump" procedure above.

Remove pump inlet hose pictured.

Place hose in a suitable waste container to gravity drain remaining fluid in tank.

Replace inlet hose after draining.

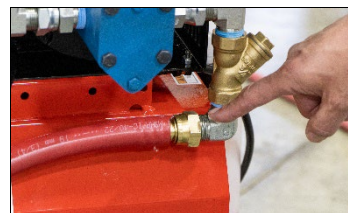

# MAINTENANCE

## To keep your machine working properly:

### **After Every Cleaning Cycle:**

Clean Oberg filter screen with a degreaser. Trying to run the flusher with a filter screen full of debris can damage your pump and motor.

### **Daily:**

Make sure the ATF level is halfway in the sight glass. Do not overfill or run with fluid level higher than halfway in the sight glass.

### **Monthly/Every 100 Flushes:**

Replace the spin on filters. This is the most important maintenance you can do on your Heated Cooler Line Flusher. Change the filters every 100 flushes (approximately once a month).

### **Quarterly:**

Replace the ATF - sooner if it's black.

### **Yearly:**

Unplug the heater from the electrical box, unscrew heater, and clean the heater's coils. Oven cleaner works very well for this.



# REPLACEMENT PARTS

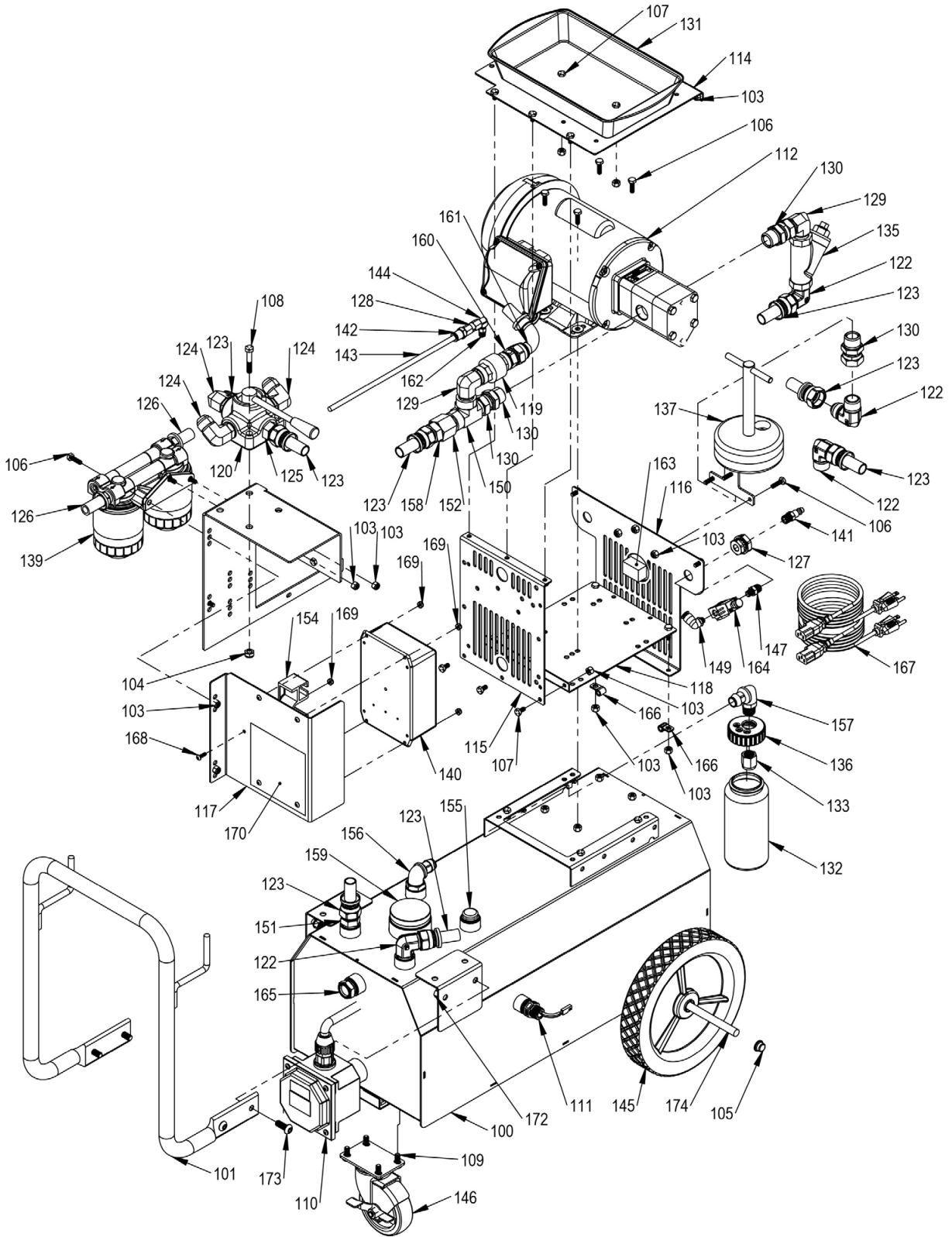

ITEM NO.	PART NO.	DESCRIPTION	QTY.
100	40300450	ASSEMBLY-GTEC TANK	1
101	40300479	ASSEMBLY-GTEC HANDLE	1
102	502000	WASHER 1/4 FLT ZN ANSI18-22-1	7
103	40201289	NUT - SS-316 NYLON, 1/4-20	32
104	940503	NUT LK 5/16/18 NYLON INSRT GR2 Z	2
105	40200476	HUB CAPS - G TEC	2
106	40201062	HEX BOLT 1/4-20 X 7/8" SS	14
107	40200544	1/4-20 X 1/2 HEX CAP SCREW UNC THREAD	18
108	501032	1/16-18 X 1-3/4 BOLT	2
109	501352	BOLT HHCS 5,16-18-3,4 GR 2	4
110	40200466	HEATER CHROMALOX - G TEC	1
111	40200576	FLOAT SWITCH - G TEC	1
112	40201337	PUMP / MOTOR ASSEMBLY - TTCF-9A	1
113	40300428	BRACKET-FILTER N VALVE MNT	1
114	40300463	BRACKET-GTEC TOP HORZ	1
115	40300462	BRACKET-GTEC FRNT VERT	1
116	40300458	PLATE-GTEC MOTOR BRKT REMOVABLE	1
117	40300464	BRACKET-ELECTRONICS MOUNTING	1
118	40300461	BRACKET-GTEC MOTOR BASE	1
119	40201371	CHECK VALVE - 3/4 NPT FEMALE	1
120	40201361	VALVE-REVERSING 4-WAY OPEN CENTER -10 PORTS	1
121	40201378	HEX DRIVE PLUG - 1/4 NPT - SS	1
122	40201352	FITTING-.75 JIC MALE X .75 MPT 90 ELBOW	5
123	40201364	FITTING -12 PUSH LOK x -12 JIC SWIVEL FEM	9
124	40201358	FITTING -12 MALE JIC x -10 SAE ORB MALE	3
125	40201359	FITTING--12 MALE JIC x -10 SAE ORB	1
126	40201366	FITTING - 3/4 PUSH-LOCK x 1/2 MALE NPT	2
127	40200339	1/4 BRASS BULKHEAD FTTG	1
128	40201390	FITTING - ELBOW 1/8 NPT HIGH PRESSURE	1
129	40201348	FITTING - 3/4 NPTF MALE x 3/4 NPTF MALE 90	2
130	40201450	FITTING - 3/4" NPTF MALE X 3/4" NPSM FEMALE SWIVEL	3
131	40200493	TOOL TRAY - G TEC	1
132	40200919	ROUND BOTTLE 16 OZ	1
133	40201373	BREATHER VENT 3/8 NPS FEMALE	1
134	40201383	CORD GRIP 1/2" KNOCKOUT	1
135	40201414	WYE STRAINER 3/4" BRONZE	1
136	40201406	CAP, BOTTLE	1
137	40201294	FILTER ASSEMBLY HIGH FLOW GTEC	1
138	40200471	FILTER BRACKET - G TEC	1
139	40300272	FILTER ASSEMBLY-SPIN ON-GTEC	2
140	40201451	ELECTRONICS-GTEC PCB	1
141	40200496	MALE PLUG WITH CHECK BALL - G TEC	1
142	40201389	FITTING - 1/8 NPT X 5/16 TUBE PTC	1
143	40201179	BLACK POLY TUBING 5/16 OD	7
144	40201427	FITTING - ELBOW 1/8 NPTF FEM X 1/8 NPTF MALE	1

145	40200458	WHEEL - G TEC	2
146	R942118	CASTER 4 W/BRAKE ATRX	1
147	40200667	STRAIGHT REDUCER HEX 1/4 X 1/8 NPT MALE (5485K31)	1
148	40200776	5/8 ID NYLON WHEEL SPACER - G TEC	2
149	40200356	5/16 TUBE X 1/8 NPT ELBOW W169PLP3 5-2	1
150	40201479	FITTING-3/4 MALE RUN TEE	1
151	40201353	FITTING-.75JIC X .75MPT STRT	1
152	40201480	FITTING-3/4 MALE NPT x 3/4 FEM ORB	1
153	40300475	PLUG-GTEC THERM	1
154	40300476	BRACKET-GTEC CORD	1
155	40200470	THERMOMETER - G TEC	1
156	40201464	FITTING - PLASTIC ELBOW 3/4 NPT MALE X 3/4 BARB	1
157	40201465	FITTING - PLASTIC ELBOW 1/2 NPT MALE X 3/4 BARB	1
158	40201461	VALVE-3/4 MALE JIC x 3/4 MALE ORB 100PSI CHECK	1
159	40201475	CAP-GTEC FILL	1
160	40201472	FITTING - 3/4" JIC MALE x 3/4" NPTF MALE PIPE WITH PORT	1
161	40201365	FITTING -12 PUSH LOK BARB x -12 JIC SWIVEL 90 ELBOW	1
162	40201473	FITTING - 1/8 NPTF MALE STRAIGHT CONNECTOR	1
163	40200514	HOUR METER - G TEC 8	1
164	40201474	SOLENOID VALVE 120V - TCF-9B	1
165	40201434	BRASS SIGHT GLASS FOR DARK LIQUID 3/4 NPTF	1
166	40201454	CLAMP-STEEL LOOP	2
167	40201482	POWER CORD - 25 FT - GTEC 9	2
168	R942145	SCREW 10-24 X 5/8 BUTTON HEAD	5
169	501143	NUT 10-24 NYLOCK ZINC	5
170	40201455	OVERLAY - CONTROL PANEL TTCF-9B	1
171	40200569	RED HOSE 3/4 - G TEC	10
172	941390	NUT 3,8-16 STAR LOCK	4
173	941271	BOLT 3/8-16 x 1 BUTTON SOCKET	4
174	40201497	STEEL ROD- .5" DIA X 16.75" L	1

# LIMITED ONE (1) YEAR WARRANTY

## G-TEC TTCF-9B by Flo-Dynamics

Flo-Dynamics warrants only to the original Purchaser that under normal use, care and service, the Equipment (except as otherwise provided herein) shall be free from defects in material and workmanship for one year from the date of original invoice. External hoses, remote control modules, adapters, and all other attachments, supplies and consumables (except as otherwise provided herein) are warranted for 90 calendar days from the date of original invoice. Filter elements are not warranted. Printed circuit boards purchased from, but not installed by Seller are not warranted.

**SELLER'S OBLIGATIONS UNDER THIS WARRANTY ARE LIMITED SOLELY TO THE REPAIR OR, AT SELLER'S OPTION, REPLACEMENT OF EQUIPMENT OR PARTS WHICH TO SELLER'S SATISFACTION ARE DETERMINED TO BE DEFECTIVE AND WHICH ARE NECESSARY, IN SELLER'S JUDGEMENT, TO RETURN THE EQUIPMENT TO GOOD OPERATING CONDITION. NO OTHER WARRANTIES EXPRESS OR IMPLIED OR STATUTORY, INCLUDING WITHOUT LIMITATION ANY IMPLIED WARRANTY OF MERCHANTABILITY OR FITNESS FOR A PARTICULAR PURPOSE, SHALL APPLY AND ALL SUCH WARRANTIES ARE HEREBY EXPRESSLY DISCLAIMED.**

This warranty does not cover (and separate charges for parts, labor and related expenses shall apply to) any damage to, malfunctioning, inoperability or improper operation of the Equipment caused by, resulting from or attributable to (A) abuse, misuse or tampering; (B) alteration, modification or adjustment of the Equipment by anyone other than Seller's authorized representatives; (D) improper or negligent use, application, operation, care, cleaning, storage or handling; (E) fire, water, wind, lightning or other natural causes; (F) adverse environmental conditions, including, without limitation, excessive heat, moisture, corrosive elements, or dust or other air contaminants, radio frequency interference, electric power failure, power line voltages beyond those specified for the equipment, unusual physical, electrical or electromagnetic stress, and/or any other condition outside of Seller's environmental specifications; (G) use of the Equipment in combination or connection with other equipment, attachments, supplies or consumables not manufactured or supplied by Seller; or (H) failure to comply with any applicable federal, state or local regulation.

Repairs or replacements qualifying under this Warranty will be performed on regular business days during Seller's normal working hours within a reasonable time following Purchaser's request. **All requests for Warranty service must be made during the stated Warranty period.** This warranty is non-transferable.