

Trademarks

Autel®, MaxiSys®, MaxiDAS®, MaxiScan®, MaxiTPMS®, MaxiRecorder®, and MaxiCheck® are trademarks of Autel Intelligent Technology Corp., Ltd., registered in China, the United States and other countries. All other marks are trademarks or registered trademarks of their respective holders.

Copyright Information

No part of this manual may be reproduced, stored in a retrieval system or transmitted, in any form or by any means, electronic, mechanical, photocopying, recording, or otherwise without the prior written permission of Autel.

Disclaimer of Warranties and Limitation of Liabilities

All information, specifications and illustrations in this manual are based on the latest information available at the time of printing.

Autel reserves the right to make changes at any time without notice. While information of this manual has been carefully checked for accuracy, no guarantee is given for the completeness and correctness of the contents, including but not limited to the product specifications, functions, and illustrations.

Autel will not be liable for any direct, special, incidental, indirect damages or any economic consequential damages (including lost profits).

IMPORTANT

Before operating or maintaining this unit, please read this manual carefully, paying extra attention to the safety warnings and precautions.

For Services and Support:



pro.autel.com
www.autel.com



1-855-288-3587/1-855-AUTELUS (North America)
0086-755-86147779 (China)



support@autel.com

For details, please refer to the [17.4 Service](#) Procedures in this manual.

Safety Information

For your own safety and the safety of others, and to prevent damage to the device and vehicles upon which it is used, it is important that the safety instructions presented throughout this manual be read and understood by all persons operating or coming into contact with the device.

There are various procedures, techniques, tools, and parts for servicing vehicles, as well as in the skill of the person doing the work. Because of the vast number of test applications and variations in the products that can be tested with this equipment, we cannot possibly anticipate or provide advice or safety messages to cover every circumstance. It is the automotive technician's responsibility to be knowledgeable of the system being tested. It is crucial to use proper service methods and test procedures. It is essential to perform tests in an appropriate and acceptable manner that does not endanger your safety, the safety of others in the work area, the device being used, or the vehicle being tested.

Before using the device, always refer to and follow the safety messages and applicable test procedures provided by the manufacturer of the vehicle or equipment being tested. Use the device only as described in this manual. Read, understand, and follow all safety messages and instructions in this manual.

Safety Messages

Safety messages are provided to help prevent personal injury and equipment damage. All safety messages are introduced by a signal word indicating the hazard level.

DANGER

Indicates an imminently hazardous situation which, if not avoided, will result in death or serious injury to the operator or to bystanders.

WARNING

Indicates a potentially hazardous situation which, if not avoided, could result in death or serious injury to the operator or to bystanders.

Safety Instructions

The safety messages herein cover situations Autel is aware of. Autel cannot know, evaluate or advise you in regards of all possible hazards. You must be certain that any condition or service procedure encountered does not jeopardize your personal safety.

 **DANGER**

When an engine is operating, keep the service area WELL VENTILATED or attach a building exhaust removal system to the engine exhaust system. Engines produce carbon monoxide, an odorless, poisonous gas that causes slower reaction time and can lead to serious personal injury or loss of life.

 **It is not advised to use headphones at a high volume**

Listening at high volumes for long periods of time may result in loss of hearing.

 **Safety Warnings**

- Always perform automotive testing in a safe environment.
- Wear safety eye protection that meets ANSI standards.
- Keep clothing, hair, hands, tools, test equipment, etc. away from all moving or hot engine parts.
- Operate the vehicle in a well-ventilated work area, for exhaust gases are poisonous.
- Put the transmission in PARK (for automatic transmission) or NEUTRAL (for manual transmission) and make sure the parking brake is engaged.
- Put blocks in front of the drive wheels and never leave the vehicle unattended while testing.
- Be extra cautious when working around the ignition coil, distributor cap, ignition wires and spark plugs. These components create hazardous voltages when the engine is running.
- Keep a fire extinguisher suitable for gasoline, chemical, and electrical fires nearby.
- Do not connect or disconnect any test equipment while the ignition is on or the engine is running.
- Keep the test equipment dry, clean, free from oil, water or grease. Use a mild detergent on a clean cloth to clean the outside of the equipment as necessary.
- Do not drive the vehicle and operate the test equipment at the same time. Any distraction may cause an accident.
- Refer to the service manual for the vehicle being serviced and adhere to all diagnostic procedures and precautions. Failure to do so may result in personal injury or damage to the test equipment.
- To avoid damaging the test equipment or generating false data, make sure the vehicle battery is fully charged and the connection to the vehicle DLC is clean and secure.

Do not place the test equipment on the distributor of the vehicle. Strong electro-magnetic interference can damage the equipment.

CONTENTS

| | |
|---|----|
| 1 USING THIS MANUAL | 1 |
| 1.1 CONVENTIONS | 1 |
| 1.1.1 <i>Bold Text</i> | 1 |
| 1.1.2 <i>Notes and Important Messages</i> | 1 |
| 1.1.3 <i>Hyperlink</i> | 2 |
| 1.1.4 <i>Illustrations</i> | 2 |
| 1.1.5 <i>Procedures</i> | 2 |
| 2 GENERAL INTRODUCTION..... | 3 |
| 2.1 MAXISYS TABLET..... | 3 |
| 2.1.1 <i>Functional Description</i> | 3 |
| 2.1.2 <i>Power Sources</i> | 5 |
| 2.1.3 <i>Technical Specifications</i> | 6 |
| 2.2 MAXIFLASH VCI –VEHICLE COMMUNICATION INTERFACE..... | 7 |
| 2.2.1 <i>Functional Description</i> | 7 |
| 2.2.2 <i>Power Sources</i> | 8 |
| 2.2.3 <i>Technical Specifications</i> | 9 |
| 2.3 ACCESSORIES KIT..... | 10 |
| 2.3.1 <i>Main Cable</i> | 10 |
| 2.3.2 <i>OBD I-Type Adapters</i> | 10 |
| 2.3.3 <i>Other Accessories</i> | 11 |
| 3 GETTING STARTED..... | 12 |
| 3.1 POWER UP..... | 12 |
| 3.1.1 <i>Application Buttons</i> | 13 |
| 3.1.2 <i>Locator and Navigation Buttons</i> | 14 |
| 3.1.3 <i>System Status Icons</i> | 15 |
| 3.2 POWER DOWN..... | 15 |
| 3.2.1 <i>Reboot System</i> | 16 |
| 4 DIAGNOSTICS..... | 17 |
| 4.1 ESTABLISH VEHICLE COMMUNICATION AND SELECTION..... | 17 |
| 4.1.1 <i>Establish Vehicle Communication</i> | 17 |
| 4.1.2 <i>Getting Started</i> | 21 |
| 4.1.3 <i>Vehicle Identification</i> | 23 |
| 4.2 DIAGNOSTICS SCREEN LAYOUT | 27 |
| 4.3 AUTO SCAN..... | 28 |

| | |
|--|----|
| 4.4 CONTROL UNIT | 34 |
| 4.4.1 Screen Messages | 35 |
| 4.4.2 Making Selections | 35 |
| 4.5 ECU INFORMATION | 35 |
| 4.6 TROUBLE CODES | 36 |
| 4.6.1 Read Codes | 36 |
| 4.6.2 Erase Codes | 38 |
| 4.7 LIVE DATA | 38 |
| 4.8 ACTIVE TEST | 45 |
| 4.9 SPECIAL FUNCTIONS | 46 |
| 4.10 PROGRAMMING AND CODING | 47 |
| 4.10.1 Coding | 48 |
| 4.10.2 Reprogramming | 49 |
| 4.10.3 Re-flash Errors | 50 |
| 4.11 GENERIC OBD II OPERATIONS | 51 |
| 4.11.1 General Procedure | 51 |
| 4.11.2 Function Descriptions | 52 |
| 4.12 DIAGNOSTIC REPORT | 55 |
| 4.12.1 Pre-Scan and Post-Scan | 55 |
| 4.12.2 Diagnostic Report PDF | 55 |
| 4.13 EXIT DIAGNOSTICS | 59 |
| 5 INTELLIGENT DIAGNOSTICS | 60 |
| 5.1 ACCESSING INTELLIGENT DIAGNOSTICS FUNCTION | 60 |
| 5.1.1 Auto Scan | 60 |
| 5.1.2 Scan System Faults | 62 |
| 5.1.3 Access via Intelligent Diagnostics Button | 64 |
| 5.1.4 Access via Intelligent Diagnostics Icon | 65 |
| 5.2 INTELLIGENT DIAGNOSTICS OPERATION | 68 |
| 5.2.1 Vehicle System and Detected DTC(s) | 69 |
| 5.2.2 Technical Service Bulletin (OEM Information) | 70 |
| 5.2.3 DTC Analysis | 70 |
| 5.2.4 Repair Assist | 71 |
| 5.2.5 Repair Tips | 71 |
| 5.2.6 Component Measurement | 78 |
| 5.2.7 Relevant Cases | 79 |

| | |
|---|-----|
| 6 SERVICE..... | 80 |
| 6.1 OIL RESET SERVICE..... | 80 |
| 6.2 ELECTRIC PARKING BRAKE (EPB) SERVICE | 81 |
| 6.2.1 <i>EPB Safety</i> | 81 |
| 6.3 TIRE PRESSURE MONITORING SYSTEM (TPMS) SERVICE..... | 81 |
| 6.4 BATTERY MANAGEMENT SYSTEM (BMS) SERVICE | 82 |
| 6.5 DIESEL PARTICLE FILTER (DPF) SERVICE | 82 |
| 6.6 IMMOBILIZER (IMMO) SERVICE | 83 |
| 6.7 STEERING ANGLE SENSOR (SAS) SERVICE..... | 84 |
| 7 DATA MANAGER..... | 85 |
| 7.1 VEHICLE HISTORY..... | 86 |
| 7.1.1 <i>Historical Test Record</i> | 87 |
| 7.2 WORKSHOP INFORMATION | 88 |
| 7.3 CUSTOMER | 89 |
| 7.4 IMAGE..... | 89 |
| 7.5 PDF FILES..... | 91 |
| 7.6 REVIEW DATA..... | 91 |
| 7.7 UNINSTALL APPS | 92 |
| 7.8 DATA LOGGING..... | 92 |
| 8 SETTINGS | 93 |
| 8.1 OPERATIONS | 93 |
| 8.1.1 <i>Unit</i> | 93 |
| 8.1.2 <i>Language</i> | 93 |
| 8.1.3 <i>Printing Settings</i> | 94 |
| 8.1.4 <i>Notification Center</i> | 95 |
| 8.1.5 <i>Auto Update</i> | 95 |
| 8.1.6 <i>ADAS Registration</i> | 96 |
| 8.1.7 <i>Vehicle List</i> | 96 |
| 8.1.8 <i>Country Code</i> | 96 |
| 8.1.9 <i>System Settings</i> | 97 |
| 8.1.10 <i>About</i> | 97 |
| 9 UPDATE..... | 98 |
| 10 VCI MANAGER | 100 |
| 10.1 WI-FI CONNECTION..... | 101 |
| 10.2 BT PAIRING..... | 102 |

| | |
|--|-----|
| 10.3 UPDATE | 103 |
| 11 ADAS..... | 104 |
| 12 SUPPORT | 105 |
| 12.1 PRODUCT REGISTRATION | 105 |
| 12.2 SUPPORT SCREEN LAYOUT..... | 105 |
| 12.3 MY ACCOUNT | 106 |
| 12.3.1 <i>Personal Info</i> | 106 |
| 12.3.2 <i>Update Info</i> | 106 |
| 12.3.3 <i>Service Info</i> | 107 |
| 12.4 COMPLAINT | 107 |
| 12.4.1 <i>Screen Layout</i> | 107 |
| 12.5 DATA LOGGING..... | 108 |
| 12.6 TRAINING | 109 |
| 12.7 FAQ DATABASE | 109 |
| 13 REMOTE DESKTOP | 110 |
| 13.1 OPERATIONS | 110 |
| 14 QUICK LINK | 112 |
| 15 MAXVIEWER | 113 |
| 16 MAXIVIDEO | 115 |
| 16.1 ADDITIONAL ACCESSORIES | 115 |
| 16.1.1 <i>MaxiVideo Camera</i> | 116 |
| 16.1.2 <i>Imager Head Accessories</i> | 116 |
| 16.1.3 <i>Accessory Assembly</i> | 117 |
| 16.1.4 <i>Technical Specifications</i> | 118 |
| 16.2 OPERATIONS | 119 |
| 17 MAINTENANCE AND SERVICE | 121 |
| 17.1 MAINTENANCE INSTRUCTIONS | 121 |
| 17.2 TROUBLESHOOTING CHECKLIST..... | 121 |
| 17.3 ABOUT BATTERY USAGE..... | 122 |
| 17.4 SERVICE PROCEDURES | 123 |
| 17.4.1 <i>Technical Support</i> | 123 |
| 17.4.2 <i>Repair Service</i> | 124 |
| 17.4.3 <i>Other Services</i> | 124 |
| 18 COMPLIANCE INFORMATION..... | 125 |
| 19 WARRANTY | 126 |

19.1 12-MONTH LIMITED WARRANTY 126

1 Using This Manual

This manual contains device usage instructions.

Some illustrations shown in this manual may contain modules and optional equipment that are not included in your system.

1.1 Conventions

The following conventions are used.

1.1.1 Bold Text

Bold text is used to highlight selectable items such as buttons and menu options.

Example:

- Tap **OK**.

1.1.2 Notes and Important Messages

Notes

A **NOTE** provides helpful information such as additional explanations, tips, and comments.

Example:

 **NOTE**

New batteries reach full capacity after approximately 3 to 5 charging and discharging cycles.

Important

IMPORTANT indicates a situation that if not avoided may result in damage to the tablet or vehicle.

Example:

 **IMPORTANT**

Keep the cable away from heat, oil, sharp edges and moving parts. Replace damaged cables immediately.

1.1.3 Hyperlink

Hyperlinks or links that take you to other related articles, procedures, and illustrations are available in electronic documents. Blue italic text indicates a selectable hyperlink and blue underlined text indicates a website link or an email address link.

1.1.4 Illustrations

Illustrations used in this manual are samples, and the actual testing screen may vary for each vehicle being tested. Observe the menu titles and on-screen instructions to make correct option selection.

1.1.5 Procedures

An arrow icon indicates a procedure.

Example:

➤ **To use the camera:**

1. Tap the **Camera** button. The camera screen opens.
2. Focus the image to be captured in the view finder.
3. Tap the camera icon on the right side of the screen. The view finder now shows the captured picture and auto-saves the taken photo.
4. Tap the thumbnail image on the top right corner of the screen to view the stored image.
5. Tap the **Back** or **Home** button to exit the camera application.

2 General Introduction

MaxiSys MS909 is a multi-platform diagnostic solution comprised of a powerful 9.7-inch TFT-LCD touchscreen Android-based tablet, a VCI communication and diagnostic unit, and an on-tool and cloud-based repair instructions and expert advice. As an intelligent diagnostic and information system, MaxiSys MS909 not only displays the relevant repairs gathered from experienced industry experts, but provides step-by-step guidance to ensure the repair is done correctly and efficiently.

There are two main components to the MaxiSys system:

- MaxiSys Tablet – the central processor and monitor for the system.
- MaxiFlash VCI - Vehicle Communication Interface.

This manual describes the construction and operation of these devices and how they work together to deliver diagnostic solutions.

2.1 MaxiSys Tablet

2.1.1 Functional Description

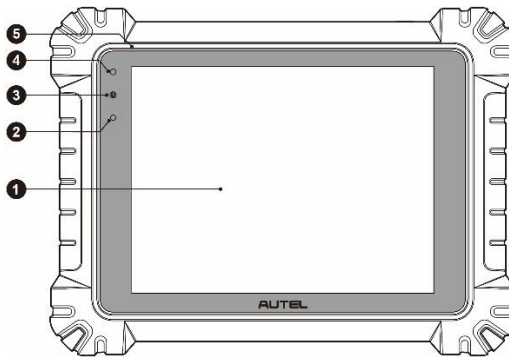

Figure 2-1 MaxiSys Tablet Front View

1. 9.7" TFT-LCD Capacitive Touch Screen
2. Ambient Light Sensor – detects ambient brightness
3. Power LED - refer to Table 2-1 Power LED Description for details
4. Front Camera
5. Built-in Microphone

Table 2-1 Power LED Description

| LED | Color | Description |
|-------|--------|--|
| Power | Green | <ul style="list-style-type: none"> Lights green when the Tablet is charging and the battery level is above 90%. Lights green when the Tablet is powered on and the battery level is above 15%. |
| | Yellow | Lights yellow when the Tablet is charging and the battery level is below 90%. |
| | Red | Lights red when the Tablet is powered on and the battery level is below 15%. |

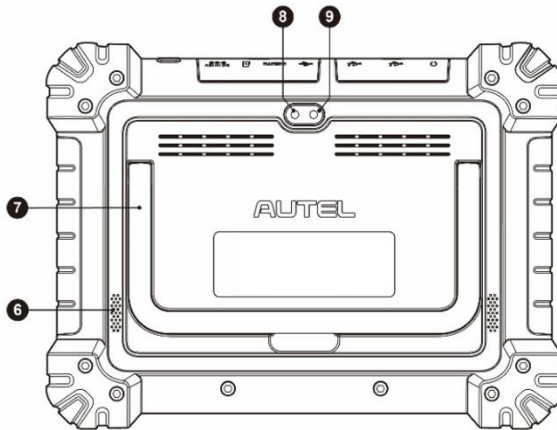

Figure 2-2 MaxiSys Tablet Back View

- 6. Speaker
- 7. Collapsible Stand – extends from the back to allow hands-free viewing of the tablet
- 8. Rear Camera
- 9. Camera Flash

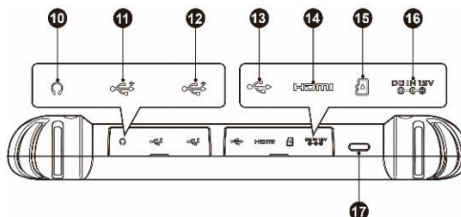

Figure 2-3 MaxiSys Tablet Top View

10. Head Phone Jack
11. USB Port
12. USB Port
13. Mini USB Port - cannot be used with the USB Port simultaneously
14. HDMI (High-Definition Multimedia Interface) Port
15. Micro SD Card Slot
16. DC Power Supply Input Port
17. Lock/Power Button – long press to turn on and off the Display Tablet, or tap the power button to lock the screen

2.1.2 Power Sources

The tablet can receive power from any of the following sources:

- Internal Battery Pack
- AC/DC Power Supply
- Vehicle Power

! IMPORTANT

Do not charge the battery when the temperature is lower than 0°C (32°F) or higher than 45°C (113°F).

Internal Battery Pack

The tablet can be powered with the internal rechargeable battery, which if fully charged can provide sufficient power for about 8 hours of continuous operation.

AC/DC Power Supply – using power adapter

The tablet can be powered from an electrical outlet using the AC/DC power adapter. The AC/DC power supply also charges the internal battery pack.

Vehicle Power

The tablet can be powered from the cigarette lighter or other DC power port on the test vehicle through a direct cable connection. The vehicle power cable connects to the DC power supply port on the top side of the display unit.

2.1.3 Technical Specifications

Table 2-2 Tablet Specifications

| Item | Description |
|---------------------------------------|---|
| Operating System | Android 7.0 |
| Processor | Samsung Exynos 8895V octa-core Processor (2.3GHz Quad-core Mongoose + 1.7GHz Quad-core A53) |
| Memory | 4GB RAM & 128GB On-board Memory |
| Display | 9.7-inch TFT-LCD with 1536 x 2048 resolution & capacitive touch screen |
| Connectivity | <ul style="list-style-type: none"> ● WiFix2 (802.11 a/b/g/n/ac 2x2 MIMO) ● BT v.2.1 + EDR ● GPS ● USB 2.0 (TWO USB HOST Type A, ONE USB mini device) ● HDMI 2.0 ● SD Card (Support up to 256GB) |
| Camera | <ul style="list-style-type: none"> ● Rear: 16 Megapixel, Autofocus with Flashlight ● Front: 5.0 Megapixel |
| Sensors | Gravity Accelerometer, Ambient Light Sensor (ALS) |
| Audio Input / Output | <ul style="list-style-type: none"> ● Microphone ● Dual Speakers ● 3-Band 3.5 mm stereo/standard headset jack |
| Power and Battery | <ul style="list-style-type: none"> ● 15000mAh 3.8V lithium-polymer battery ● Charging via 12V AC/DC power supply with the temperature between 0°C and 45°C |
| Input Voltage | 12V/3A Adapter |
| Operating Temp. | 0 to 50°C (32 to 122°F) |

| Item | Description |
|--------------------|---|
| Storage Temp. | -20 to 60°C (-4 to 140°F) |
| Dimensions (WxHxD) | 304.4 mm (11.98") x 227.8 mm (8.97") x 42.5 mm (1.67") |
| Weight | 1.66kg (3.66 lb.) |
| Protocols | DoIP, PLC J2497, ISO-15765, SAE-J1939, ISO-14229 UDS, SAE-J2411 Single Wire Can(GMLAN), ISO-11898-2, ISO-11898-3, SAE-J2819 (TP20), TP16, ISO-9141, ISO-14230, SAE-J2610 (Chrysler SCI), UART Echo Byte, SAE-J2809 (Honda Diag-H), SAE-J2740 (GM ALDL), SAE-J1567 (CCD BUS), Ford UBP, Nissan DDL UART with Clock, BMW DS2, BMW DS1, SAE J2819 (VAG KW81), KW82, SAE J1708, SAE-J1850 PWM (Ford SCP), SAE-J1850 VPW (GM Class2) |

2.2 MaxiFlash VCI –Vehicle Communication Interface

2.2.1 Functional Description

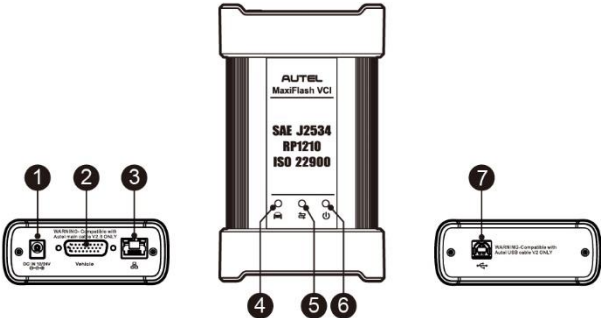

Figure 2-4 MaxiFlash VCI Programming Device

1. DC Power Supply Input Port
2. Vehicle Data Connector
3. Ethernet Port

4. Vehicle LED

- Flashes green when the device is communicating with the vehicle system

5. Connection LED

- Lights solid green when the device is properly connected with the display tablet via the USB cable
- Lights solid cyan (blue/ green) when connected via Wi-Fi; lights solid blue when connected via wireless BT connection

6. Power LED

- Lights solid green when powered on
- Flashes red when VCI is upgrading
- Lights solid red when system failure occurs
- Lights yellow automatically at power up when VCI is self-testing

7. USB Port

ⓘ IMPORTANT

Do not disconnect the programming device while the vehicle LED status light is on! If the flash programming procedure is interrupted while the vehicle's ECU is blank or only partially programmed, the module may be unrecoverable.

Programming Capability

The MaxiFlash VCI device is a D-PDU, SAE J2534 & RP1210 compliant PassThru programming interface device. Using the updated OEM software, it is capable of replacing the existing software/firmware in the Electronic Control Units (ECU), programming new ECUs and fixing software-controlled drivability issues and emission issues.

Communication Capability

The MaxiFlash VCI device supports Bluetooth (BT), Wi-Fi, and USB communications. It can transmit vehicle data to the tablet with or without a cable connection. In open areas, the working range of the transmitter through BT communication is up to 328 feet (about 100 m). The working range of 5G Wi-Fi is up to 164 feet (50 m). If the signal is lost due to being taken out of range, communication will be restored once the tablet is within range.

2.2.2 Power Sources

The VCI device can receive power from the following sources:

- Vehicle Power

- AC/DC Power Supply

Vehicle Power

The VCI device operates on 12/24 Volt vehicle power, which receives power via the vehicle data connection port. The device powers on whenever it is connected to an OBD II/EOBD compliant data link connector (DLC). For non OBD II/EOBD compliant vehicles, the device can be powered from a cigarette lighter or other suitable power port on the test vehicle using the auxiliary power cable.

AC/DC Power Supply

The VCI device can be powered from a wall socket using the AC/DC power adapter.

2.2.3 Technical Specifications

Table 2-3 MaxiFlash VCI Specifications

| Item | Description |
|-------------------------------|--|
| Communications | <ul style="list-style-type: none"> ● BT V2.1 + EDR ● USB 2.0 ● Wi-Fi 5G ● Ethernet |
| Wireless Frequency | 5 GHz |
| Input Voltage Range | 12 VDC to 24 VDC |
| Supply Current | <ul style="list-style-type: none"> ● 170 mA @12 VDC ● 100 mA @ 24 VDC |
| Operating Temp. | 0°C to 50°C |
| Storage Temp. | -20°C to 60°C |
| Dimensions (L x W x H) | 149 mm (5.87") x 86 mm (3.38") x 35 mm (1.28") |
| Weight | 0.29 kg (0.64 lb.) |

Note

For additional information, please refer to the accompanied user manual for the VCI device.

2.3 Accessories Kit

2.3.1 Main Cable

The VCI device can be powered through the Autel Main Cable V2.0 (the V2.0 icon can be seen on the cable) when connected to an OBD II/EOBD compliant vehicle. The Main Cable connects the VCI device to the vehicle's data link connector (DLC), through which the VCI device can transmit vehicle data to the tablet.

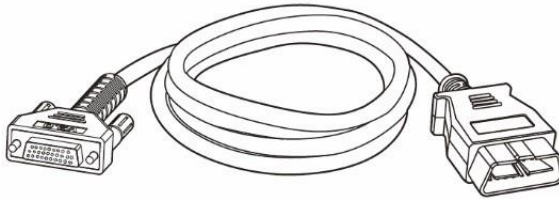

Figure 2-5 Main Cable – 1.5m in Length

Note

MaxiFlash VCMI and MaxiFlash VCI can be connected by the Autel Main Cable V2.0 only. DO NOT use other Autel main cables to connect the MaxiFlash VCMI and MaxiFlash VCI.

2.3.2 OBD I-Type Adapters

The OBD I-type adapters are for Non-OBD II vehicles. The adapter used depends on the type of vehicle being tested. The most common adapters are shown below (Adapters may be sold separately, please contact your distributor for details).



Benz-14



Chrysler-16



BMW-20



Nissan-14



Kia-20



Fiat-3



PSA-2



Mazda-17



VW/Audi-2+2



Benz-38



Mitsubishi/
Hyundai-12+16

2.3.3 Other Accessories



Autel USB Cable V2 (the V2 icon can be seen on the cable)

Connects the tablet to the VCI unit.

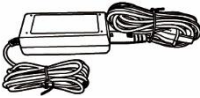

AC/DC External Power Adapter

Connects the tablet to the external DC power port for power supply.



Cigarette Lighter

Provides power to the tablet or the VCI device through connection to the vehicle cigarette lighter receptacle, as some non-OBD II vehicles cannot provide power via the DLC connection.



Clipper Cable

Provides power to the tablet or the VCI device through connection to the vehicle battery.

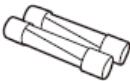

Light Fuse x2

A safety device for the cigarette lighter.

3 Getting Started

Make sure the tablet has sufficient power or is connected to the external power supply (see [2.1.2 Power Sources](#) on page 5).

3.1 Power Up

Long press (press and hold) the Lock/Power button on the top right side of the tablet to switch the unit on. The system boots up and shows the lock screen with 3 entry options.

1. MaxiSys Home – Swipes up the MaxiSys Home icon to enter the MaxiSys Job Menu shown as below.
2. Unlock – Swipes up the Lock icon at the center to unlock the screen or enter the MaxiSys Job Menu when booting up.
3. Camera – Swipes up the Camera icon to launch the camera.

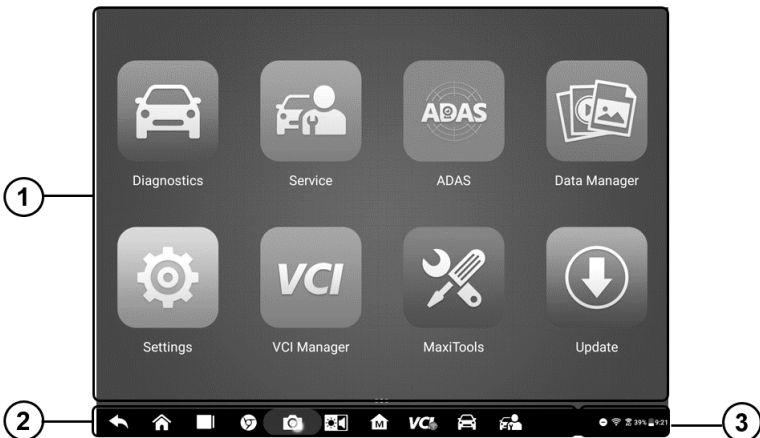

Figure 3-1 Sample MaxiSys Job Menu

1. Application Buttons
2. Locator and Navigation Buttons
3. Status Icons

NOTE









It is recommended to lock the screen when not in use to protect information in the system and conserve the power.



Almost all operations on the tablet are controlled through the touchscreen. The touchscreen navigation is menu driven, which allows you to quickly locate the test procedure, or data that you need, through a series of questions and options. Detailed descriptions of the menu structures are found in the chapters for each application.

3.1.1 Application Buttons

The table below briefly describes each of the applications in the MaxiSys system.

Table 3-1 Applications







| Name | Button | Description |
|-----------------------|---|---|
| Diagnostics |  | Accesses the unit's diagnostic functions. See Diagnostics on page 17. |
| Service |  | Accesses special functions menu. See Service on page 80. |
| Data Manager |  | Accesses the saved repair shop, customer and vehicle data including detailed vehicle diagnostics and test records. See Data Manager on page 85. |
| Settings |  | Accesses the system settings menu and general tablet menu. See Settings on page 93. |
| Update |  | Accesses system software update menu. See Update on page 98. |
| VCI Manager |  | Accesses VCI connection menu. See VCI Manager on page 100. |
| ADAS |  | Accesses ADAS systems menu. See ADAS on page 104. |
| Support |  | Synchronizes Autel's online service database with the MaxiSys tablet. See Support on page 105. |
| Remote Desktop |  | Configures your unit to receive remote support using the TeamViewer application. See Remote Desktop on page 110. |





| Name | Button | Description |
|------------|---|--|
| Quick Link |  | Provides associated website bookmarks to allow quick access to product update, service, support and other information. See Quick Link on page 112. |
| MaxiViewer |  | Provides a quick search for supported functions and/or vehicles. See MaxiViewer on page 113. |
| MaxiVideo |  | Configures the unit to operate as a video scope device by connecting to an Imager head cable for close vehicle inspections. See MaxiVideo on page 115. |

3.1.2 Locator and Navigation Buttons

Operations of the Navigation buttons at the bottom of the screen are described in the table below:

Table 3-2 Locator and Navigation Buttons

| Name | Butto | Description |
|---------------|---|---|
| Locator |  | Indicates the location of the screen. Swipe the screen left or right to view the previous or next screen. |
| Back |  | Returns to the previous screen. |
| Android Home |  | Returns to Android System's Home screen. |
| Recent Apps |  | Displays a list of applications that are currently running. Tap an app icon to launch. Remove an app by swiping it to the right. |
| Browser |  | Launches the Chrome Internet browser. |
| Camera |  | Tap icon to open camera viewfinder. Press and hold icon to capture a screenshot of the display screen. The saved files are auto-stored in the Data Manager application for later review. See Data Manager on page 85. |
| Display&Sound |  | Adjusts the brightness of the screen and the volume of the audio output. |

| Name | Butto | Description |
|-------------------------|---|--|
| MaxiSys Home |  | Returns to MaxiSys Job Menu. |
| VCI |  | Opens the VCI Manager application. A green icon at the bottom right corner indicates the VCI device is connected, while a red cross icon will display if connection fails. The battery status icon displays the remaining VCI power. |
| MaxiSys Shortcut |  | Returns to the Diagnostics screen. |
| Service |  | Returns to the Service screen. |

➤ **To use the camera**

1. Tap the **Camera** button. The camera screen opens.
2. Focus the image to be captured in the view finder.
3. Tap the camera icon on the right side of the screen. The view finder now shows the captured picture and auto-saves the taken photo.
4. Tap the thumbnail image on the top right corner of the screen to view the stored image.
5. Tap the **Back** or **Home** button to exit the camera application.

 **Note**

After swiping the camera screen from left to right, the camera mode and video mode can be switched by tapping the blue camera icon or video icon.

Refer to Android documentation for additional information.

3.1.3 System Status Icons

Your MaxiSys tablet is fully functional Android tablet with the standard Android operation system status icons. Refer to Android documentation for additional information.

3.2 Power Down

All vehicle communications should be terminated before shutting down the tablet. A warning message displays if a shutdown is attempted while the tablet is communicating with the vehicle. Forcing a shutdown while the tablet is communicating with the vehicle may lead to ECU problems on some vehicles. Please exit the Diagnostics application before shutting off the tablet.

➤ **To power down the MaxiSys tablet**

1. Press and hold the Lock/Power button.
2. Tap **Power off** option.
3. Tap **OK**.

3.2.1 Reboot System

In case of system crash, long press the Lock/Power button and tap **Reboot** to restart the system.

4 Diagnostics

The Diagnostics application can access the electronic control module of multiple vehicle control systems, including but not limited to the engine, transmission, anti-lock brake system (ABS), and airbag system (SRS).

4.1 Establish Vehicle Communication and Selection

4.1.1 Establish Vehicle Communication

The Diagnostics operations require connecting the MaxiSys MS909 tablet to the test vehicle through the VCI device using the Main Cable (Use the applicable OBD I-type adapter if needed). To establish proper vehicle communication with the tablet, you need to perform the following steps:

1. Connect the VCI device to the vehicle's DLC for both communication and power source.
2. Connect the VCI device to the tablet via BT pairing, Wi-Fi or USB connection.
3. When the above steps are completed, check the VCI navigation button at the bottom bar on the screen. If a green BT, Wi-Fi or USB icon displays at the lower right corner, the MaxiSys MS909 Diagnostic Platform is ready to start vehicle diagnosis.

4.1.1.1 Vehicle Connection

The method used to connect the VCI device to a vehicle's DLC depends on the vehicle's configuration as follows:

- A vehicle equipped with an On-board Diagnostics Two (OBD II) management system supplies both communication and 12-volt power through a standardized J-1962 DLC.
- A vehicle not equipped with an OBD II management system supplies communication through a DLC connection, and in some cases supplies 12-volt power through the cigarette lighter receptacle or a connection to the vehicle battery.

OBD II Vehicle Connection

This type of connection only requires the main cable without any additional adapter.

➤ **To connect to an OBD II vehicle**

1. Connect the main cable's female adapter to the Vehicle Data Connector on the VCI device, and tighten the captive screws.
2. Connect the cable's 16-pin male adapter to the vehicle's DLC, which is generally

located under the vehicle dash.

 **NOTE**

The vehicle's DLC is not always located under the dash; refer to the user manual of the test vehicle for additional connection information.

Non-OBD II Vehicle Connection

This type of connection requires both the main cable and a required OBD I adapter for the specific vehicle being serviced.

There are three possible conditions for Non-OBD II vehicle connection:

- DLC connection supplies both communication and power.
- DLC connection supplies communication and power is to be supplied via the cigarette lighter connection.
- DLC connection supplies communication and power is to be supplied via connection to the vehicle battery.

➤ **To connect to a Non-OBD II Vehicle**

1. Connect the main cable's female adapter to the Vehicle Data Connector on the VCI device, and tighten the captive screws.
2. Locate the required OBD I adapter and connect its 16-pin jack to the main cable's male adapter.
3. Connect the attached OBD I adapter to the vehicle's DLC.

 **NOTE**

Some vehicles may have more than one adapter or may have test leads instead of an adapter. Make the proper connection to the vehicle DLC as required.

➤ **To connect the cigarette lighter**

1. Plug the DC power connector of the cigarette lighter into the DC power supply input port on the device.
2. Connect the male connector of the cigarette lighter into the vehicle's cigarette lighter receptacle.

➤ **To connect the clipper cable**

1. Connect the tubular plug of the clipper cable to the male connector of the cigarette lighter.

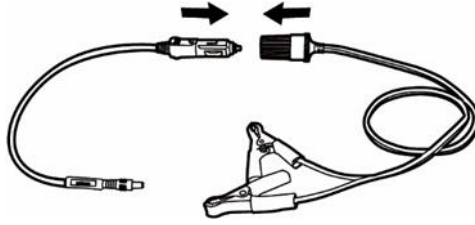

Figure 4-1 Connection between Cigarette Lighter and Clipper Cable

2. Plug the DC power connector of the cigarette lighter into the DC power supply input port of the VCI device.
3. Connect the clipper cable to the vehicle's battery.

NOTE

After the VCI device is successfully connected to the vehicle, the Power LED on the device lights, and a beep sound will be heard.

4.1.1.2 VCI Connection

After the VCI device is properly connected to the vehicle, the Power LED on the VCI device lights solid green, and is ready to establish communication with the tablet.

Coming with the MaxiSys MS909 tool kit, the VCI device supports three communication methods with the tablet: BT, Wi-Fi and USB.

Pairing Up via BT

In open areas, the working range for BT communication is about 328 feet (100 m), giving technicians greater mobility to perform vehicle diagnosis from anywhere in the repair shop.

To expedite multi-vehicle diagnostics, more than one VCI can be used in busy repair shops enabling technicians to quickly pair via BT their MaxiSys tablet to each VCI separately and therefore eliminating the need to unplug the VCI from one vehicle and then connect it to another each time.

➤ **To pair the tablet with the VCI device via BT**

1. Power up the tablet.
2. Select the **VCI Manager** application from the MaxiSys Job Menu.
3. When the **VCI Manager** application is opened, the device automatically scans for available VCI devices for BT pairing. The found devices are listed in the Setting section on the right side of the screen.

NOTE

If no VCI device is found, this may indicate that the signal strength is too weak to be detected. Reposition the VCI device, and remove all possible objects that may cause signal interference. Tap the **Scan** button at the top right corner to rescan for VCI.

4. Typically, the VCI device name displays as Maxi suffixed with a serial number.

Select the VCI device for pairing. (If more than one VCI is used in the shop, ensure the correct VCI is selected to pair.)

5. When pairing is successful, the connection status displays as Connected.
6. The VCI icon on the tablet Navigation bar in the bottom displays a green circle BT icon when the tablet and the VCI are connected.

Refer to [10.2 BT Pairing](#) on page 102 for additional information.

Wi-Fi Connection

The VCI device supports 5 GHz Wi-Fi connection. In open areas, the working range of 5G Wi-Fi communication is up to 164 feet (50 m).

➤ To pair the tablet with the VCI device via Wi-Fi

1. Power up the tablet.
2. Select the **VCI Manager** application from the MaxiSys Job Menu.
3. When the **VCI Manager** application is opened, the tablet automatically scans for available VCI devices for Wi-Fi connection. Found VCI devices are listed in the Setting section on the right side of the screen.
4. Typically, the VCI device name displays as Maxi suffixed with a serial number. Select the required device for connection.
5. When pairing is successful, the connection status is shown as Connected.
6. The VCI icon on the tablet Navigation bar at the bottom displays a green circle Wi-Fi icon when the tablet and the VCI are connected.

Refer to [Wi-Fi Connection](#) on page 101 for additional information.

USB Cable Connection

The USB cable connection is a simple and quick way to establish communication between the tablet and the VCI device. After properly connecting the USB cable from the tablet to the VCI device, the VCI navigation button at the bottom bar of the screen displays a green check mark and the USB LED on the VCI device lights solid green, indicating the connection between the devices is successful.

The MaxiSys diagnostic platform is now ready to perform vehicle diagnosis.

NOTE

Since the USB connection provides the most stable communication and is therefore the recommended communication method between the tablet and VCI when operating ECU programming or coding. The USB communication method will take priority over other connected communication methods.

4.1.1.3 No Communication Message

- A. If the tablet is unable to connect to the VCI, an “Error” message displays. An “Error”

message indicates the tablet is not communicating with the VCI device. Troubleshoot the error by performing the following steps:

- Ensure the VCI device is powered on.
 - When using the wireless connection, ensure the network is configured correctly and the proper device has been connected.
 - If the tablet loses communication abruptly during the diagnosis, ensure no objects are causing signal interruption.
 - Ensure the VCI device is properly positioned with the VCI front side up.
 - Move the tablet closer to the VCI device. If using the wired connection, ensure the cable is securely attached to the VCI.
 - Ensure the VCI communication mode is lit for the selected communication type: BT, Wi-Fi or USB.
- B. If the VCI device is unable to establish a communication link, a message will display troubleshooting instructions. Possible causes for the communication error include:
- The VCI device is unable to establish a communication link with the vehicle.
 - A vehicle system has been selected for diagnosis that is not supported by the vehicle.
 - There is a loose connection.
 - There is a blown vehicle fuse.
 - The vehicle or the data cable has a wiring fault.
 - There is a circuit fault in the data cable or adapter.
 - The vehicle identification is incorrectly entered.

4.1.2 Getting Started

Prior to first use of the Diagnostics application, ensure the VCI device is properly connected to and is communicating with the tablet. See [VCI Manager](#) on page 100.

4.1.2.1 Vehicle Menu Layout

When the VCI device is properly connected to the vehicle, and paired to the tablet, the platform is ready to start vehicle diagnosis. Tap on the Diagnostics application button on the MaxiSys Job Menu, the Vehicle Menu displays on the screen.



Figure 4-2 Sample Vehicle Menu Screen





1. Top Toolbar Buttons
2. Manufacturer Buttons

Top toolbar Buttons

The operations of the Toolbar buttons at the top of the screen are listed and described in the table below:

Table 4-1 Top Toolbar Buttons

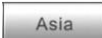
| Name | Button | Description |
|-----------|--------|---|
| Home | | Returns to the MaxiSys Job Menu. |
| VID Scan | | Tap this button to open a dropdown list; tap Auto Detect for auto VIN detection; tap Manual Input to enter VIN code or license number manually. Tap Scan VIN/License to scan the VIN code/license numbers by camera. |
| All | | Displays all the vehicle makes in the vehicle menu. |
| Favorites | | Displays user-selected favorite vehicle makes. |
| History | | Displays the stored test vehicle history records. This option provides direct access to the previously tested vehicle recorded during previous tests. See 7.1 Vehicle History on page 86. |

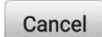
| Name | Button | Description |
|----------------|---|---|
| America |  | Displays the American vehicle menu. |
| Europe |  | Displays the European vehicle menu. |
| Asia |  | Displays the Asian vehicle menu. |
| China |  | Displays the Chinese vehicle menu. |
| Search |  | Tap inside the search field to display the virtual keyboard and input the vehicle manufacturer to test. |
| Cancel |  | Tap this button to exit the search screen or cancel an operation. |

Manufacturer Buttons

The Manufacturer buttons display the various vehicle brand names. Select the manufacturer button after the VCI device is properly connected to the test vehicle to start a diagnostic session.

4.1.3 Vehicle Identification

The MaxiSys diagnostic system supports five methods of Vehicle Identification.

1. Auto VIN Scan
2. Manual Input
3. Scan VIN/License
4. Manual Vehicle Selection
5. OBDII Direct Entry

4.1.3.1 Auto VIN Scan

The MaxiSys diagnostic system features the latest VIN-based Auto VIN Scan function to identify CAN vehicles in just one tap, enabling the technician to quickly identify the exact vehicle and scan its available systems for fault codes.

➤ To perform Auto VIN Scan

1. Tap the **Diagnostics** application button from the MaxiSys Job Menu. The Vehicle Menu displays.
2. Tap the **VID Scan** button on the top toolbar.
3. Select **Auto detect**. The tablet starts VIN scanning on the vehicle's ECU. Once the

test vehicle is successfully identified, the system will guide you to the Vehicle Diagnostics screen.



Figure 4-3 Sample Auto Detect Screen

Depending on the vehicle, the Auto VIN function is still available after a vehicle brand is selected.

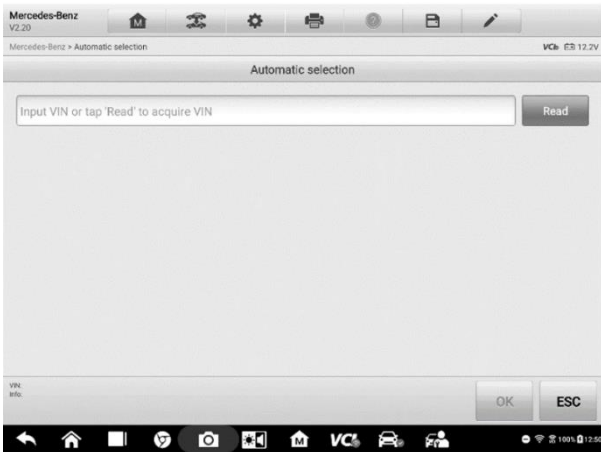

Figure 4-4 Sample Automatic Selection Screen

Select **Automatic Selection** and the system will acquire VIN information automatically or allow users to input the VIN manually.

4.1.3.2 Manual Input

For vehicles that do not support the Auto VIN Scan function, the MaxiSys diagnostic system allows you to enter the vehicle VIN or license numbers manually, or simply take a photo of the VIN sticker or license plate for quick vehicle identification.

➤ **To perform Manual Input**

1. Tap the **Diagnostics** application button from the MaxiSys Job Menu. The Vehicle Menu displays.
2. Tap the **VID Scan** button on the top toolbar.
3. Select **Manual input**.
4. Tap the input box and enter the correct VIN code or license numbers.

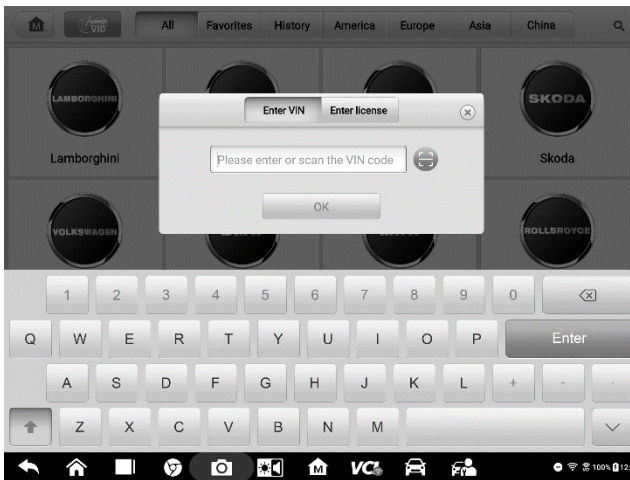

Figure 4-5 Sample Manual VIN Input

5. Tap **OK**. The vehicle will be identified and matched to the vehicle database and the Vehicle Diagnostics screen will display.
6. Tap the cross icon on the top right corner to exit Manual Input.

4.1.3.3 Scan VIN/License

Tap **Scan VIN/License** in the dropdown list (**Figure 4-3**), the camera will be opened. On the right side of the screen, from top to bottom, three options are available: **Scan bar code**, **Scan VIN**, and **Scan License**.

Note

The method of Scan License is supported in some countries and areas. Please manual input the license number if it is not available.

Select one of three options and position the tablet to align the VIN or license numbers within the scanning window, the result displays in the Recognition result dialog box after scanned. Tap **OK** to confirm the result, and then the vehicle information confirmation

screen will display on the tablet. If all the vehicle information is correct, tap the icon in the middle of the screen to confirm the VIN of the vehicle being tested, tap **OK** to continue.

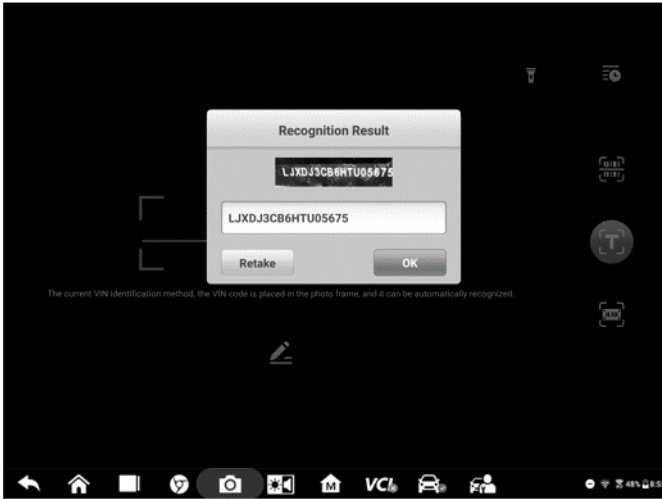

Figure 4-6 Sample Scan VIN Code 1

If the VIN/License numbers can't be scanned, please manually input the VIN/License numbers. Tap **OK** to continue. Manually input the license numbers and select a vehicle brand in the vehicle information confirmation screen. Tap the icon in the middle of the screen to confirm the VIN of the vehicle being tested, tap **OK** to continue.

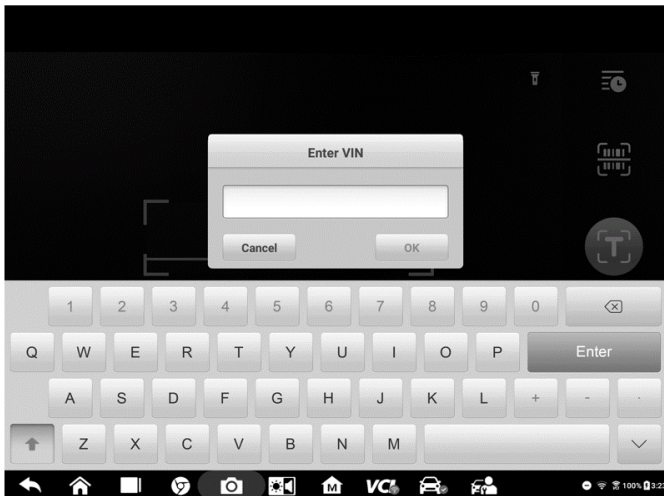

Figure 4-7 Sample Scan VIN Code 2

4.1.3.4 Manual Vehicle Selection

When the vehicle's VIN is not automatically retrievable through the vehicle's ECU, or the specific VIN is unknown, you can select the vehicle manually.

Step-by-step Vehicle Selection

This mode of vehicle selection is menu driven. Select **Manufacturer** icon on the Vehicle Menu screen and the 'Select diagnostic type' screen displays, then tap **Manual selection** button. Select the vehicle information like the Brand, Model, Capacity, Engine type and Model year on the same screen. Each selection you make advances you to the next screen. The **Esc** button at the lower right corner of the screen will bring you back to the previous screen. Tap **Reset** button to reselect the vehicle information if needed.

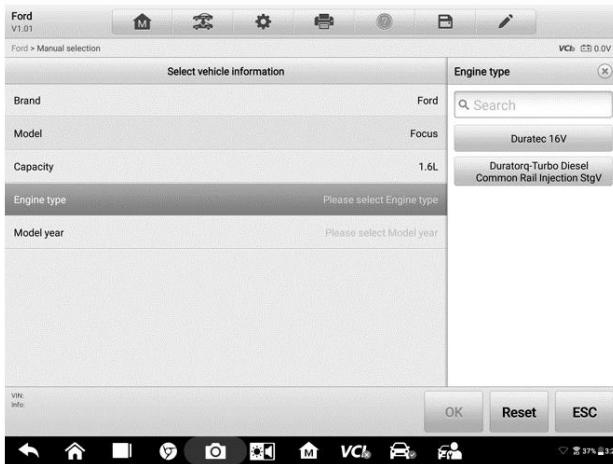

Figure 4-8 Sample Manual Vehicle Selection Screen

4.1.3.5 Alternative Vehicle Identification

Occasionally, the tablet may not be able to identify a vehicle. For these vehicles, the user may perform a generic OBDII or EOBD diagnostics. See [Generic OBD II Operations](#) on page 51 for additional information.

4.2 Diagnostics Screen Layout

After the vehicle information is selected. Tap the OK button at the bottom right corner of the screen (See **Figure 4-9**) to open the Main menu page. This section consists of various functions commonly used, including Auto Scan, Control Unit, and more. The available functions displayed vary by vehicle.

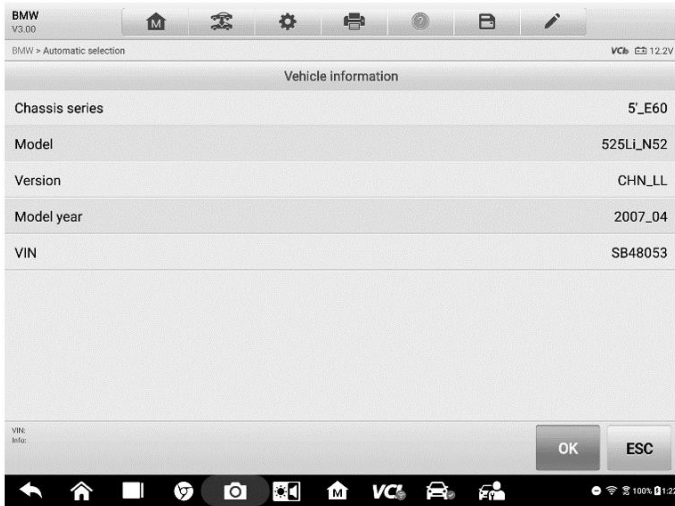

Figure 4-9 Sample Vehicle Information Selection Screen

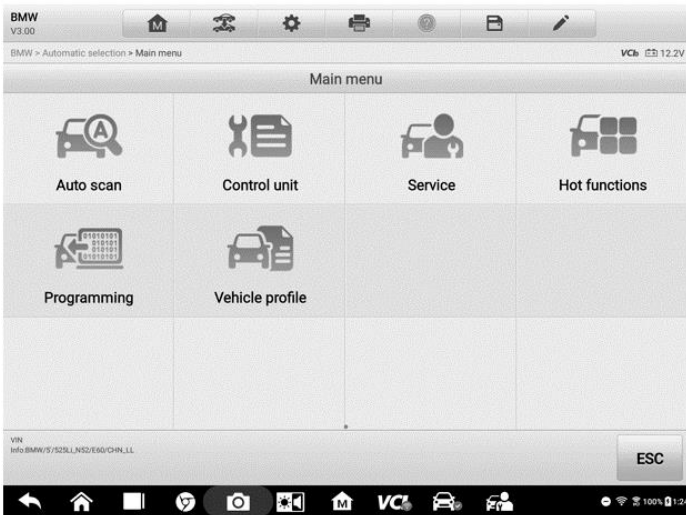

Figure 4-10 Sample Main Menu Screen

4.3 Auto Scan

The Auto Scan function performs a comprehensive scanning of all the systems in the vehicle ECU to locate faults and retrieve DTCs. Tap **Fault Scan** to start. Systems with no faults detected will display in green; systems containing faults will display orange.

➤ To perform Auto Scan function

Take topology for Land Rover as an example:

1. Tap the **Diagnostics** application button on the MaxiSys Job Menu. Choose the corresponding vehicle information and enter the vehicle diagnostic page.
2. Select **Auto scan** on the Main menu to enter the diagnostic interface.
3. The Topology tab page displays in the main section. Tap the **Fault Scan** button at the bottom of the screen to scan the vehicle system modules.
4. A system scanned with no fault detected displays in green; a system scanned with faults detected will display in orange. The number of total faults will display on the upper right corner.

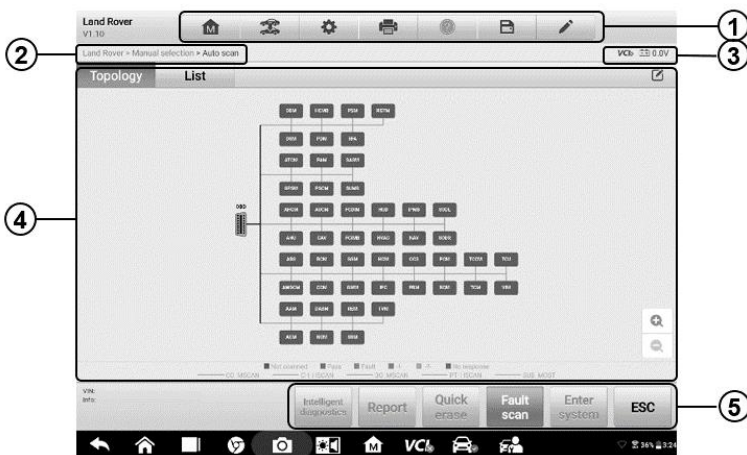



Figure 4-11 Sample Auto Scan Screen

NOTE







On the Auto Scan screen, there is a **Select System icon**  on the upper right corner. Select the corresponding system(s) to scan, saving more time than scanning all systems.

1. Diagnostics Toolbar
2. Current Directory Path
3. Status Information Bar
4. Main Section
5. Functional Buttons

Diagnostics Toolbar

The Diagnostics Toolbar contains buttons that allow you to print or save the displayed data and perform other operations. The table below provides a brief description for the operations of the Diagnostics toolbar buttons:

Table 4-2 Diagnostics Toolbar Buttons

| Name | Button | Description |
|--------------|---|--|
| Home |  | Returns to the MaxiSys Job Menu. |
| Vehicle Swap |  | Exits the diagnostic session and returns to the vehicle menu screen to select another vehicle for testing. |
| Settings |  | Opens the setting screen. See Settings on page 93. |
| Print |  | Saves and prints a copy of the displayed data. See Print Settings on page 94. |
| Help |  | Provides instructions or tips for operations of various diagnostic functions. |
| Save |  | <p>Opens a submenu for the 3 options to save data:</p> <ul style="list-style-type: none"> • Tap Save This Page to take a screenshot image • Tap Save All Data to save a PDF file (use this save option when data displays on multiple screens) <p>These files are stored in Data Manager application for later reviews. See Data Manager on page 85.</p> |
| Data Logging |  | <p>Use this function when encountering an error when testing or diagnosing a vehicle. This function will record the communication data and ECU information of the test vehicle and send it to Autel technical staff to review and provide solution.</p> <p>Go to the Support application to follow up the processing progress, see Data Logging on page 108.</p> |

➤ **To print data in Diagnostics**

1. Tap the **Diagnostics** application button on the MaxiSys Job Menu. The **Print** button in the diagnostic toolbar is available throughout the whole Diagnostics operations.
2. Tap **Print** and a drop-down menu displays.
3. **Print This Page** – prints a screenshot copy of the current screen.
4. **Print All Data** – prints a PDF copy of all displayed data.
5. A temporary file will be created and sent via the computer to the printer.

6. When the file is sent, a confirmation message displays.

NOTE

Make sure the tablet and the printer are connected either by Wi-Fi or LAN before printing. For more instructions on printing, see [Printing Settings](#) on page 94 for details.

➤ **To submit Data Logging reports in Diagnostics**

1. Tap the **Diagnostics** application button from the MaxiSys Main Screen. The pen-shaped **Data Logging** button on the diagnostic toolbar is available throughout the whole Diagnostics operations.
2. Tap the **Data Logging** button (a pen icon) to display the error options. Select a specific error, and a submission form will display to let you fill in the report information.
3. Tap the **Send** button in the upper right corner of the screen to submit the report form via the Internet, a confirmation message displays when sent successfully.

Current Directory Path

The Directory Path shows all directory names to access the current page.

Status Information Bar

The Status Information Bar at the top of the Main Section displays the following items:

1. **VCI Icon** – indicates the communication status between the tablet and the VCI device.
2. **Battery Icon** – indicates the battery status of the vehicle.

Main Section

The Main Section varies depending on the stage of operations which shows vehicle identification selections, the main menu, test data, messages, instructions and other diagnostic information.

The Main Section of Auto Scan screen displays a System List for most vehicles, and a topology map at the same time for some makes, including Volkswagen, Audi, BMW, Ford, Land Rover, Jaguar, Chrysler, Fiat, and Volvo.

A. Topology Tab Page

The Topology Tab page displays a system distribution diagram of the vehicle control modules.

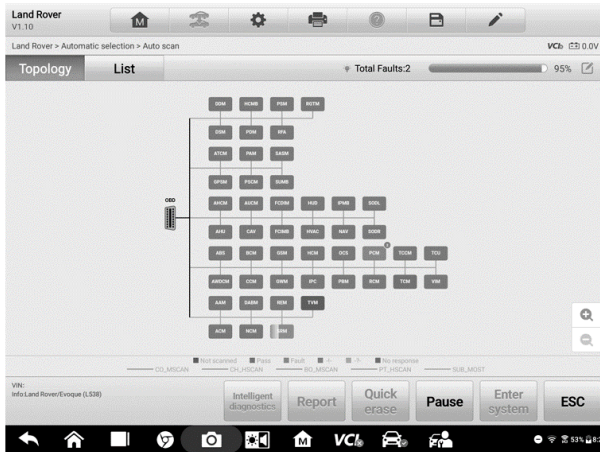

Figure 4-12 Sample Topology Tab Page

B. List Tab Page

Column 1 – displays the system numbers.

Column 2 – displays the scanned systems.

Column 3 – displays the scan results.

- ❖ **-!-**: Indicates that the scanned system may not support the code reading function, or there is a communication error between the tester and the control system.
- ❖ **-?-**: Indicates that the vehicle control system has been detected, but the tester cannot access it.
- ❖ **Fault | #**: Indicates there is/are detected fault code(s) present; “#” indicates the quantity of detected faults.
- ❖ **Pass | No Fault**: Indicates the system was scanned and no faults has been detected.
- ❖ **Not Scanned**: Indicates the system has not been scanned.
- ❖ **No Response**: Indicates the system has not received a response.

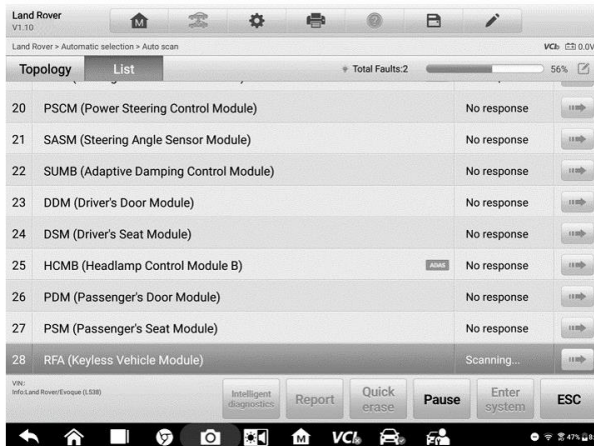

Figure 4-13 Sample List Tab Page

Functional Buttons

The type of Functional Buttons displayed at the bottom of the screen vary by operation. Function include cause, reporting, code clearing, exit scanning, and other functional controls. The functions of these buttons will be described in the following sections when relevant.

The table below provides a brief description of the Functional Buttons' operations:

Table 4-3 Functional Buttons in Diagnostics Screen

| Name | Description |
|--------------------------------|---|
| Intelligent Diagnostics | Directly accesses the Intelligent Diagnostics function to view the fault code analysis information of ALL DTCs. See Intelligent Diagnostics Operation on page 68. |
| Report | Displays the diagnostic data in the report form. |
| Quick Erase | Erases all fault information after scanning. |
| Fault Scan | Scans vehicle system modules. |
| Pause | Pauses the scanning process. |
| Enter System | Enters the ECU system. |
| ESC | Returns to the previous screen or exit the Diagnostics Screen. |

Select one of the system modules from the Topology or List, and tap **Enter System** to enter the specific system functions.

NOTE

The Diagnostic Buttons Toolbar (located on the top of the screen) will be active throughout the diagnostic session for such tasks as printing and saving the displayed data, obtaining help information, or performing data logging.

4.4 Control Unit

The **Control Unit** allows you to manually locate a required control system for testing through a series of choices. Simply follow the menu driven procedure, and make proper selection each time; the program will guide you to the diagnostic function menu after a few choices you've made.

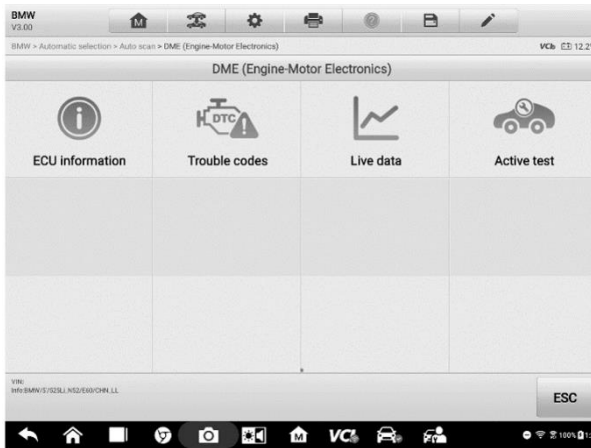

Figure 4-14 Sample Function Menu Screen

Available functions may vary by vehicle. The function menu may include:

- **ECU Information** – displays detailed ECU information. Select to display information screen.
- **Trouble codes** – contains Read Codes and Erase Codes. The former displays detailed DTC information retrieved from the vehicle control module, the latter allows you to erase DTCs and other data from the ECU.
- **Live Data** – retrieves and displays live data and parameters from the vehicle's ECU.
- **Active test** – provides specific subsystem and component tests. This selection may display as *Actuators*, *Actuator Test*, or *Function Tests*. Available tests vary by vehicle.
- **Special functions** – provides component adaptation or variant coding functions for custom configurations, and allows entry of adaptive values for certain components after repairs. Depending on the test vehicle, this selection may sometimes appear as *Control Unit Adaptations*, *Variant Coding*, *Configuration* or something similar.

4.4.1 Screen Messages

Messages display when additional input is needed before proceeding. There are mainly three types of on-screen messages: Confirmation, Warning, and Error.

- **Confirmation Messages**

This type of messages usually displays as an "Information" screen, when you are about to perform an action that cannot be reversed or when an action has been initiated and your confirmation is needed to continue.

When a user-response is not required, the message displays briefly.

- **Warning Messages**

This type of messages displays when completing the selected action may result in an irreversible change or loss of data. An example of this message is the "Erase Codes" message.

- **Error Messages**

Error messages display when a systemic or procedural error has occurred. Possible errors include cable disconnection and communication interruption.

4.4.2 Making Selections

The Diagnostics application is a menu-driven program that presents a series of options one at a time. As you select from a menu, the next menu in the series displays. Each selection narrows the focus and leads to the desired test. Use your fingertip or the stylus pen to make menu selections.

4.5 ECU Information

This function retrieves and displays the specific information for the tested control unit, including unit type and version numbers.

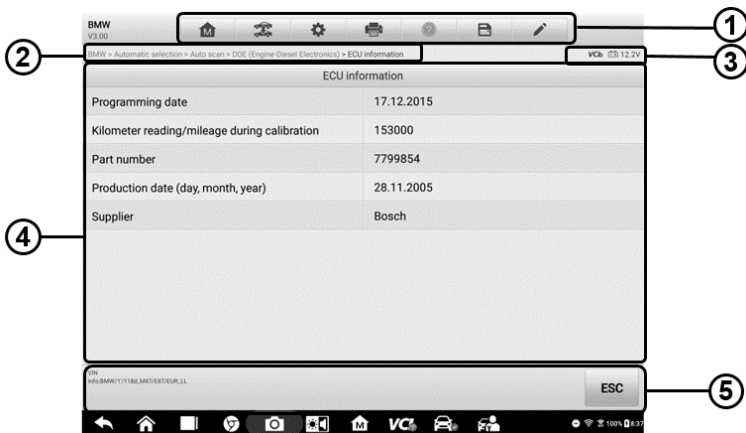

Figure 4-15 Sample ECU Information Screen

1. Diagnostics Toolbar Buttons – see [Table 4-2 Diagnostics Toolbar Buttons](#) on page 30 for detailed descriptions of the operations of each button.
2. Current Directory Path
3. Status Information Bar
4. Main Section – the left column displays the item names; the right column displays the specifications or descriptions.
5. Functional Button – in this case, only an **ESC** button is available; tap it to exit after viewing.

4.6 Trouble Codes

4.6.1 Read Codes

This function retrieves and displays the DTCs from the vehicle control system. The Read Codes screen varies for each vehicle being tested. For some vehicles, freeze frame data can also be retrieved for viewing. A sample Read Codes screen displays as below:

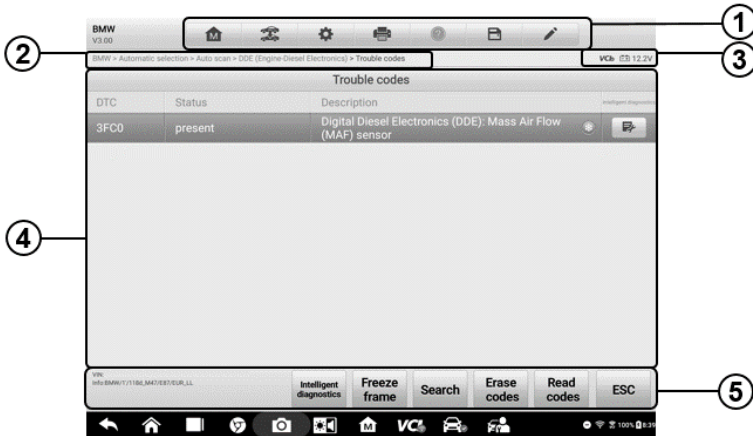

Figure 4-16 Sample Read Codes Screen

1. Diagnostics Toolbar – see [Table 4-2 Diagnostics Toolbar Buttons](#) on page 30 for details.
2. Current Directory Path
3. Status Information Bar
4. Main Section
 - Column 1 – displays the retrieved codes from the vehicle.
 - Column 2 – indicates the status of the retrieved codes.
 - Column 3 – detailed descriptions for the retrieved codes.
 - Column 4 – provides access to the Intelligent Diagnostics screen.
5. Functional Buttons
 - **Intelligent Diagnostics** – tap to enter the Intelligent Diagnostics screen to check related repair cases and help information.
 - **Freeze Frame** – icon displays when freeze frame data is available for viewing; Tap icon to display data screen. The Freeze Frame interface is similar to that of the Read Codes interface and share similar operations.
 - **Search** – tap to search the selected DTC for additional information on the Internet.
 - **Erase codes** – tap to erase codes from the ECU. It is recommended that DTCs are read and needed repairs are performed before erasing codes.
 - **Read codes** - retrieves and displays the DTCs from the vehicle control system. The Read Codes screen varies for each vehicle being tested.
 - **ESC** – tap it to return to the previous screen or exit the function.

4.6.2 Erase Codes

After reading the retrieved codes from the vehicle and certain repairs have been made, you can erase the codes from the vehicle using this function. Before performing this function, make sure the vehicle's ignition key is in the ON (RUN) position with the engine off.

➤ To erase codes

1. Tap **Erase Codes** in the Function Menu.
2. A warning message displays to inform you of data loss when this function is applied.
 - a) Tap **Yes** to continue. A confirming screen displays when the operation is successfully done.
 - b) Tap **No** to exit.
3. Tap **ESC** on the confirming screen to exit Erase Codes.
4. Check the Read Codes function again to ensure the operation is successful.

4.7 Live Data

When this function is selected, the screen displays the data list for the selected module. The parameters display in the order that they are transmitted by the ECU, so expect variation among vehicles.

Gesture scrolling allows you to quickly move through the data list. Touch the screen and drag your finger up or down to reposition the parameters being displayed if the data occupies more than one screen. The figure below displays a typical Live Data screen:

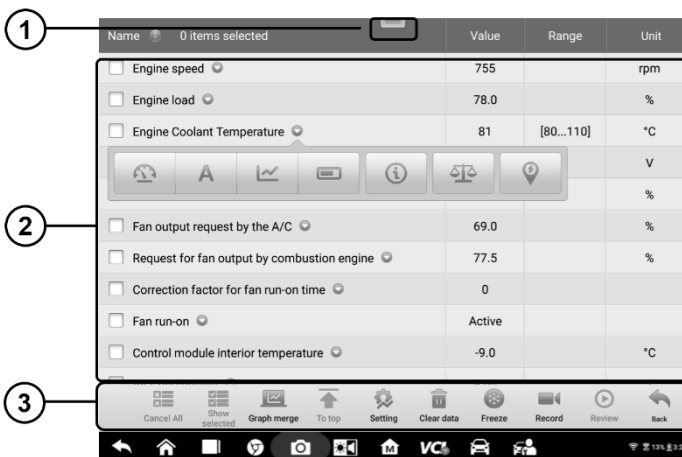

Figure 4-17 Sample Live Data Screen

1. **Diagnostics Toolbar Buttons** – Tap the parallel icon at the top of the screen to display diagnostics toolbar buttons. See [Table 4-2 Diagnostics Toolbar Buttons](#) on page 30 for detailed descriptions of the operations for each button.

2. Main Section

- Name Column – this column displays the parameter names.
 - a) Check Box – tap the check box to the left of a parameter name to select the item. Tap the check box again to deselect it.
 - b) Drop-down Button – tap the drop-down button on the right side of the parameter name to open a submenu, which provides optional modes that display the data.
- Value Column – displays the values of the parameter items.
- Range Column – display the ranges of the parameter items.
- Unit Column – displays the unit for the parameter values.
 - To change the Unit mode, tap the **Setting** button in the top toolbar and select a required mode. See [Unit](#) on page 93.

Display Mode

There are four types of display modes available for data viewing, allowing you to view various types of parameters in the mode best suited to represent the data.

Tap the drop-down button on the right side of the parameter name to open a submenu. A total of 7 buttons will be displayed: The 4 buttons to the left represent different data display modes, plus one **Information** button, active when additional information is available, and one **Unit Change** button, for switching the unit of displayed data, and one **Trigger** button, tap to open the "trigger setting" window.

| Name | Value | Range | Unit |
|---|--------|------------|------|
| <input type="checkbox"/> Engine speed | 755 | | rpm |
| <input type="checkbox"/> Engine load | 78.0 | | % |
| <input type="checkbox"/> Engine Coolant Temperature | 81 | [80...110] | °C |
| <div style="border: 1px solid gray; padding: 5px; display: flex; justify-content: space-around;"> 📊 A 📈 📄 ℹ️ ⚖️ 📍 </div> | | | |
| <input type="checkbox"/> Fan output request by the A/C | 69.0 | | % |
| <input type="checkbox"/> Request for fan output by combustion engine | 77.5 | | % |
| <input type="checkbox"/> Correction factor for fan run-on time | 0 | | |
| <input type="checkbox"/> Fan run-on | Active | | |
| <input type="checkbox"/> Control module interior temperature | -9.0 | | °C |
| <input type="checkbox"/> Air Conditioning | 5.00 | | °C |

Cancel All Show selected Graph merge To top Setting Clear data Freeze Record Review Back

Figure 4-18 Sample Display Mode Screen

Each parameter item displays the selected mode independently.

- ✦ **Analog Gauge Mode** – displays the parameters in gauge charts.
- ✦ **Text Mode** – the default mode that displays the parameters as a text list.

NOTE

Status parameters, such as a switch reading like ON, OFF, ACTIVE, and ABORT can only be displayed in Text Mode. Value parameters, such as a sensor reading, can be displayed in both text and graph modes.

- ✦ **Waveform Graph Mode** – displays the parameters in waveform graphs.

In this mode, five control buttons will display on the right side of the parameter item, allowing you to manipulate the display status.

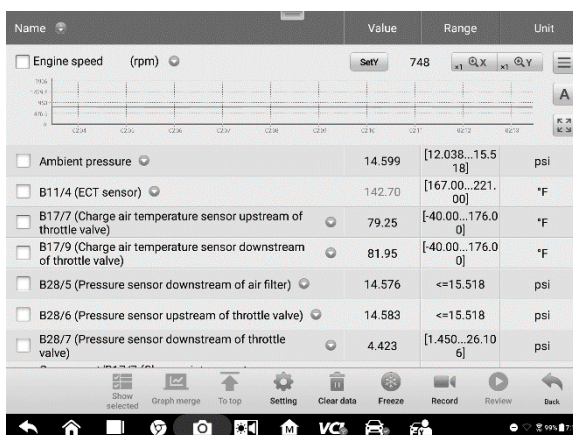

Figure 4-19 Sample Waveform Graph Mode Screen

1. **Settings Button (SetY)** – Sets the minimum and maximum value of the Y axis.
2. **Scale Button** – changes the scale values.

There are two scale buttons, displayed above the waveform graph to the right side, which can be used to change the scale values of the X axis and Y axis of the graph. There are four scales available for the X axis: x1, x2, x4 and x8. There are three scales available for the Y axis: x1, x2, and x4.

3. **Edit Button** – edit the waveform color and the line thickness.
4. **Zoom-in Button** – tap once to display the selected data graph in full screen.
5. **Exit Button** – tap to exit the waveform graph mode.

Full Screen Display – this option is only available in the waveform graph mode, and mostly used in Graph Merge status for data comparison. There are three control buttons available on the top right side of the screen under this mode.

- **Scale Button** – tap to change the scale values below the waveform graph. There

are four scales available for the X axis: x1, x2, x4 and x8. There are three scales available for the Y axis: x1, x2, and x4.

- Edit Button – tap to open an edit window, in which you can set the waveform color and the line thickness displayed for the selected parameter item.
- Zoom-out Button – tap to exit full screen display.
- Exit Button – tap to exit the waveform graph mode.

➤ **To edit the waveform color and line thickness in a data graph**

1. Select parameter items to display in Waveform Graph mode.
2. Tap the **Edit Button**, and an edit window displays.

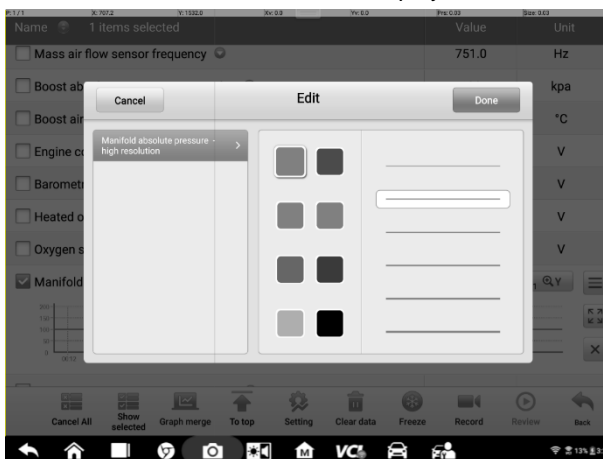

Figure 4-20 Sample Waveform Edit Screen

3. The parameter item is selected automatically in the left column.
4. Select a color from the second column.
5. Select a line thickness from the right column.
6. Tap **Done** to save the setting and exit, or tap **Cancel** to exit without saving.

NOTE

In full screen display, please edit the waveform color and line thickness by tapping the Edit button on the top right side of the screen.

Trigger Setting

On the trigger setting screen, you can set a standard range by filling in a Minimum value and a Maximum value. When exceeding this range, the trigger function will be executed and the device will automatically record and save the generated data. You can check the saved live data by tapping the "Review" button at the bottom of the screen.

Tap the drop-down button on the right side of the parameter name to open a submenu.

The **Trigger** button is the last one in the submenu. Tap to display the trigger setting window.

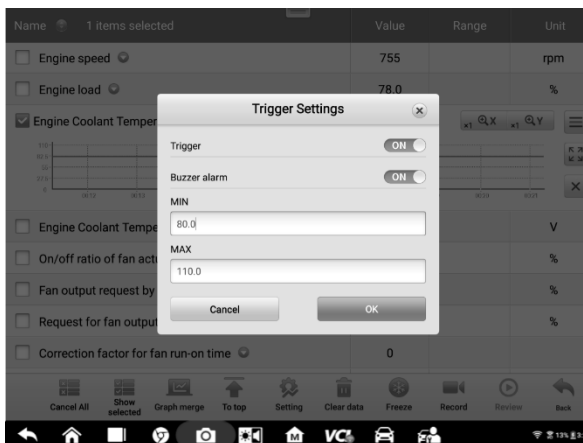

Figure 4-22 Sample Trigger Setting Screen

Two buttons and two input boxes are available in the Trigger Setting window.

- Trigger On – switches the trigger on and off. The trigger is ON by default.
- Buzzer Alarm – switches the alarm on and off. The alarm function makes a beep sound as an alert when the data reading reaches the preset minimum or maximum point. The buzzer alarm will only sound at the first trigger.
- MIN – tap this input box to display a virtual keyboard to enter the required lower limit value.
- MAX – tap this input box to display a virtual keyboard to enter the required upper limit value.

➤ **To set a trigger**

- Tap the drop-down button on the right side of the parameter name to open a submenu.
- Tap the **Trigger** button on the right side of the submenu to open the trigger settings window.
- Tap the **MIN** button on the right side, and enter the required minimum value.
- Tap the **MAX** button on the right side, and enter the required maximum value.
- Tap **OK** to save the setting and return to the Live Data screen; or tap Cancel to exit without saving.

When the trigger is successfully set, a trigger mark displays in front of the parameter name. The mark is gray when it is not triggered, and displays orange when triggered. Moreover, two horizontal lines display on each of the data graphs (when Waveform

Graph Mode is applied) to indicate the alarm point. The limit lines are shown in different colors to differentiate them from the parameter waveforms.

✧ **Digital Gauge Mode** – displays the parameters in the form of a digital gauge graph.

3. Functional Buttons

The operations of all available functional buttons on the Live Data screen are described below:

✧ **Cancel All** - Tap this button to cancel all selected parameter items. Up to 50 parameters can be selected at one time.

✧ **Show Selected/Show All** – tap this button to switch between the two options; one displays the selected parameter items, the other displays all the available items.

✧ **Graph Merge** – tap this button to merge selected data graphs (for Waveform Graph Mode only). This function is very useful when comparing different parameters.

NOTE

This mode supports Graph Merge of 2 to 5 parameters that can be represented digitally. Non-digital parameters are not supported.

➤ **To merge selected data graphs**

- 1) Select parameter items to be merged.
- 2) Tap the **Graph Merge** button at the bottom of the Live Data screen.
 - a) This mode only supports parameters that can be represented digitally. If non-digital parameters are selected, a message will display advising the user that the selected parameters are not supported in this mode and to select 2 to 5 digital parameters. Tap Got It button to return to the previous screen and select supported parameters.
 - b) If parameters are selected that are not supported in this mode, a message will display advising the user to selected only parameters that are supported. A message will also display if more than 5 parameters have been selected. Please select 2 to 5 of the supported parameters and tap **OK** button to merge.
- 3) Tap **Cancel Merging** button at the bottom of the Live Data screen to cancel merge.

✧ **To Top** – moves a selected data item to the top of the list.

✧ **Setting** – tap this button to set recording duration. Five options are available: 5 seconds, 15 seconds, 30 seconds, 60 seconds and 90 seconds.

➤ **To set live data record duration**

1. Tap **Setting** button at the bottom of the Live Data screen.
2. Tap the > button to the right of **Recording time after trigger** bar and select a

time length.

3. Tap **OK** to save the setting and return to the Live Data Setting screen; or tap the X button at the upper right corner to exit without saving.
4. Tap **Done** at the upper right corner of the Live Data Setting screen to confirm and save the setting, and return to the Live Data screen; or tap **Cancel** to exit without saving.

❖ **Clear Data** – tap this button to clear all cached live data.

❖ **Freeze** – displays the retrieved data in freeze mode.

- Previous Frame – moves to the previous frame of frozen data.
- Next Frame – moves to the next frame of frozen data.
- Play/Pause – tap to play/pause the frozen data.
- Resume – tap to exit the freeze data mode and return to normal data display.

❖ **Record** – starts recording the live data of the selected data items. Tap the **Record** button at the bottom of the Live Data screen. A message will display prompting user to select parameters to record. Tap **Got It** button to confirm. Scroll down and select data to record. Tap the **Record** button to start recording. Tap Resume button to stop recording. The recorded live data can be viewed in the **Review** section at the bottom of the Live Data screen. The recorded data can also be reviewed in the Data Manager application.

- Resume – Tap this button to stop data recording and to return to normal data display.
- Flag – this button displays when the Record function is applied. Tap this button to set flags to note points of interest when recording data. Notes can be added during playback in Review or *Data Manager*. Select the preset flag to open a popup window and display virtual keyboard to input notes.

❖ **Review** – review the recorded data. Tap Review button to display a recording list, and select one item to review.

 **NOTE**

Only the data recorded during the current operation can be reviewed on the Live Data screen. All the historical recorded data can be reviewed in "Review Data" in the Data Manager application.

- Previous Frame – switches to the previous frame of recorded data.
- Next Frame – switches to the next frame of recorded data.
- Play/Pause – tap to play/pause the recorded data.
- Show Selected – display the selected parameter items.

- Graph Merge - merge selected data graphs.
- Back – exit the review, and return to the Live Data screen.

◇ **Back** – returns to the previous screen or exits the function.

4.8 Active Test

The Active Test function is used to access vehicle-specific subsystem and component tests. Available tests vary by vehicle.

During an active test, the tablet sends commands to the ECU to activate the actuators. This test determines the integrity of the system or part by reading ECU data, or by monitoring the operation of the actuators. Such tests may include switching a solenoid, relay, or switch, between two operating states.

Selecting Active Test displays a menu of test options. Available tests vary by vehicle. Select test from menu options. Follow the instructions displayed on the screen to complete test. Procedures and instructions vary by vehicle.

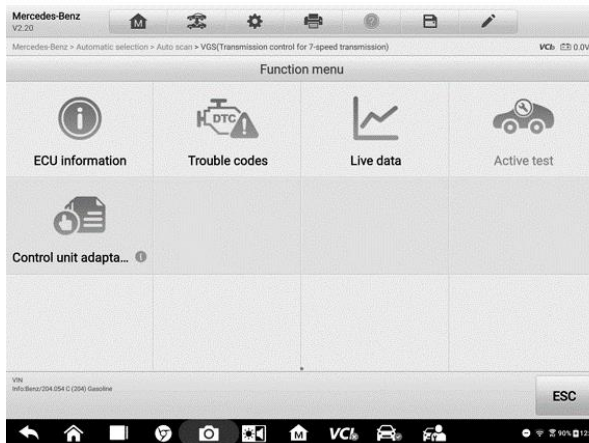

Figure 4-22 Sample Active Test Screen 1

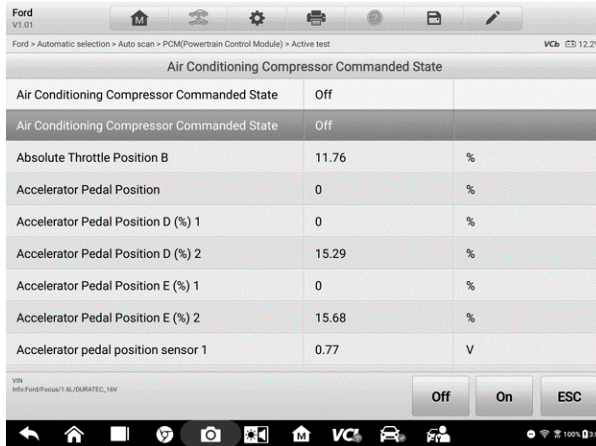

Figure 4-23 Sample Active Test Screen 2

The functional buttons in the lower right corner of the Active Test screen manipulate the test signals. The operational instructions are displayed in the main section of the test screen. Follow the on-screen instructions and make appropriate selections to complete the tests.

Tap the **ESC** functional button to exit the test when finished.

4.9 Special Functions

These functions perform various component adaptations, including the recalibration or configuration of certain components after repairs or replacements have been completed.

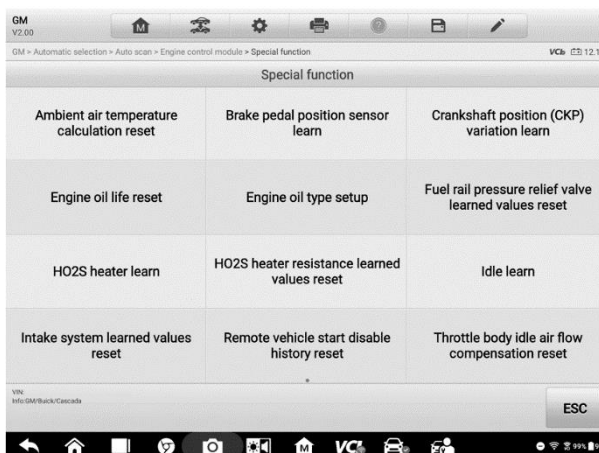
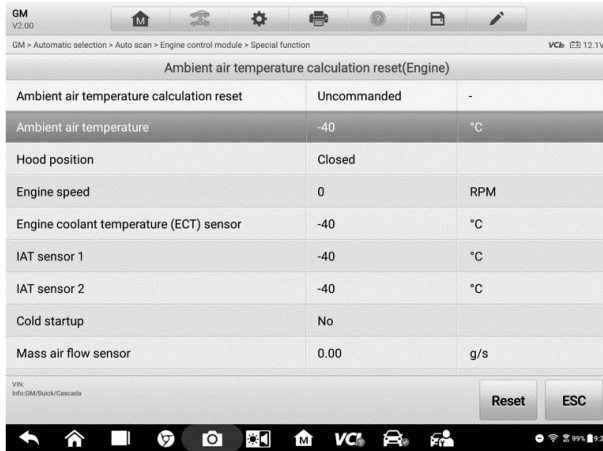

Figure 4-24 Sample Special Function Screen 1

Select function to display detailed Function information and execution screen.



The screenshot shows a diagnostic tool interface with a table of engine parameters. The table has three columns: parameter name, value, and unit. The parameters include ambient air temperature calculation reset, ambient air temperature, hood position, engine speed, engine coolant temperature (ECT) sensor, IAT sensor 1, IAT sensor 2, cold startup, and mass air flow sensor. The values are: Uncommanded, -40, Closed, 0, -40, -40, -40, No, and 0.00. The units are: -, °C, RPM, °C, °C, °C, and g/s. There are 'Reset' and 'ESC' buttons at the bottom right of the table.

| Ambient air temperature calculation reset(Engine) | | |
|---|-------------|-----|
| Ambient air temperature calculation reset | Uncommanded | - |
| Ambient air temperature | -40 | °C |
| Hood position | Closed | |
| Engine speed | 0 | RPM |
| Engine coolant temperature (ECT) sensor | -40 | °C |
| IAT sensor 1 | -40 | °C |
| IAT sensor 2 | -40 | °C |
| Cold startup | No | |
| Mass air flow sensor | 0.00 | g/s |

Figure 4-25 Sample Special Function Screen 2

List Tab Page

- Column 1 – displays the description of the function being performed or displays live data corresponding to the special function
- Column 2 – displays the execution status such as Completed or Activated or may display live data values that correspond to the special function
- Column 3 – displays the measurement units of the live data

Tap the Functional buttons to perform the selected function or exit the function.

4.10 Programming and Coding

Since the introduction of OBD II and leading up to modern Hybrids and EVs, hardware and software technologies in cars have been advancing at an exponential rate. Updating software may be the only way to fix the following issues:

- Drivability
- Fuel Efficiency
- Power Loss
- Fault Codes
- Durability of Mechanical Parts

The Programming and Coding function is used to re-flash the vehicle control modules, which allows you to update the computer software of the vehicle to the latest version, as well as to reprogram adaptive data of certain components after making repairs or replacements.

NOTE

The programming function applies only when the vehicle is connected with a VCI device, which serves as a PassThru interface to establish communication with and transfer data to the vehicle's ECU.

Available programming or coding operations vary by test vehicle. Only the available operations display in the tablet menu.

There are two general types of programming operations:

- A. Coding – also known as *Teach-in Program*, or *Component Adaptation*, is used to reprogram adaptive data for vehicle control modules after repairs or replacements of vehicle parts.
- B. Reprogramming – downloads the latest version of software from the online server database through Internet access (this procedure is done automatically when the tablet is connected to the Internet, so there is no need to check for software updates yourself), and reprograms the newest version into the vehicle's ECU.

NOTE

Ensure that the tablet is connected to a stable internet access before applying the ECU programming function, so that the tablet is able to obtain access to the vehicle manufacturer's server for update service.

Selecting the Programming or Coding function opens a menu of operation options that varies by vehicle make and model. Selecting a menu option either displays a programming interface or opens another menu of additional choices. Follow all screen instructions while performing the programming or coding operations. How and what information is presented on the screen vary by the type of operation being performed.

4.10.1 Coding

The main section of the Coding screen displays a list of vehicle components and the coding information that mainly consists of two parts:

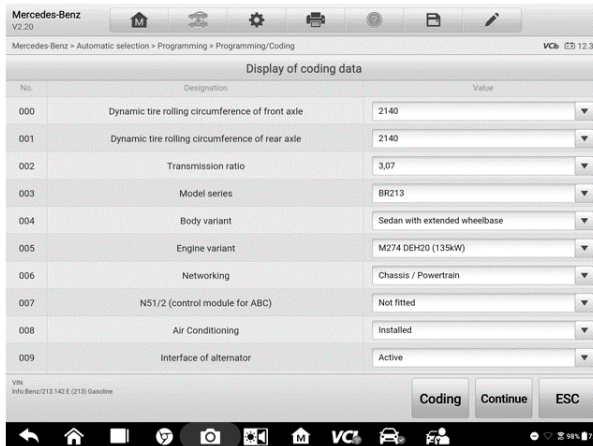

Figure 4-26 Sample Coding Screen

1. All available systems for coding are displayed on the left side, and the coding data or value on the right side.
2. The bottom of the main section displays the functional buttons that enable you to manipulate the operation.

Check the vehicle condition and the coding information carefully. Use the functional button to edit Codes for the corresponding components. Tap **Send** when you finish editing all items. When the operation is completed, an execution status message such as Completed, Finished or Successful, may display.

Tap the **ESC** button to exit the function.

4.10.2 Reprogramming

Before reprogramming begins

- It is mandatory that the tablet is connected to a stable Wi-Fi network.
- Tablet must be connected to VCI by USB.
- Tablet battery must be fully charged during module programming. Connect tablet to charger if needed.
- Attach battery maintainer to vehicle battery to ensure a steady voltage is maintained throughout programming. Voltage requirements differ by vehicle manufacturer. Consult vehicle manufacturer recommendations prior to programming a module.
- Do not quit the application during a module programming as the process may fail and may also result in permanent damage to the module.

Typical reprogramming operations require you to input and validate VIN number first. Tap the input box and enter the correct number. The programming interface then displays.

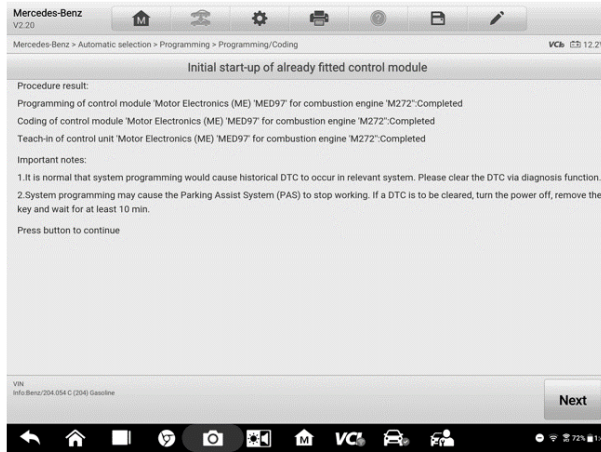

Figure 4-27 Sample Reprogramming Operation Screen

The main section of the reprogramming interface offers information of the hardware, the current software version and the newest software versions to be programmed into the control units.

A series of on-screen operational instructions will display to guide you through the programming procedure.

Carefully read the on-screen information and follow the instruction to execute the programming procedure.

4.10.3 Re-flash Errors

! IMPORTANT

When reprogramming onboard, always make sure the vehicle battery is fully charged and in good working condition. During reprogramming, the operation may fail if voltage falls below the proper operation voltage. Sometimes a failed operation can be recovered, but the failed reprogramming can also ruin the control module. We recommend connecting an external battery maintainer to the vehicle to ensure a steady voltage is maintained throughout programming. The required voltage differs by vehicle manufacturer. Consult vehicle manufacturer for correct voltage to be maintained.

Occasionally a flash update procedure may not complete properly. Common causes of flash errors include poor cable connections between the tablet, VCI, and vehicle, the vehicle ignition being switched off before the flash procedure is complete, or low vehicle battery voltage.

If the process quits, recheck all the cable connections to assure good communications and initialize the flash procedure. The programming procedure will automatically repeat if the previous operation does not succeed.

4.11 Generic OBD II Operations

The OBD II/EODB vehicle diagnosis option offers a quick way to check for DTCs, isolate the cause of an illuminated malfunction indicator lamp (MIL), check monitor status prior to emissions certification testing, verify repairs, and perform other emissions-related services. The OBDII direct access option is also used for testing OBD II/EODB-compliant vehicles that are not included in the Diagnostics database. Diagnostics toolbar buttons at the top of the screen are available for specific vehicle diagnostics. See [Table 4-2 Diagnostics Toolbar Buttons](#) on page 30 for details.

4.11.1 General Procedure

➤ **To access the OBD II/EODB diagnostics functions**

1. Tap the **Diagnostics** application button in the MaxiSys Job Menu. The Vehicle Menu displays.
2. Tap the **EODB** button. There are two options to establish communication with the vehicle.
 - Auto Scan – select it to establish communication using each protocol in order to determine which one the vehicle is using.
 - Protocol – select it to open a submenu of various protocols. A communication protocol is a standardized way of data communication between an ECM and a diagnostic tool. Global OBD may use several different communication protocols.
3. Select a specific protocol if the **Protocol** option is selected. Wait for the OBD II Diagnostic Menu to appear.

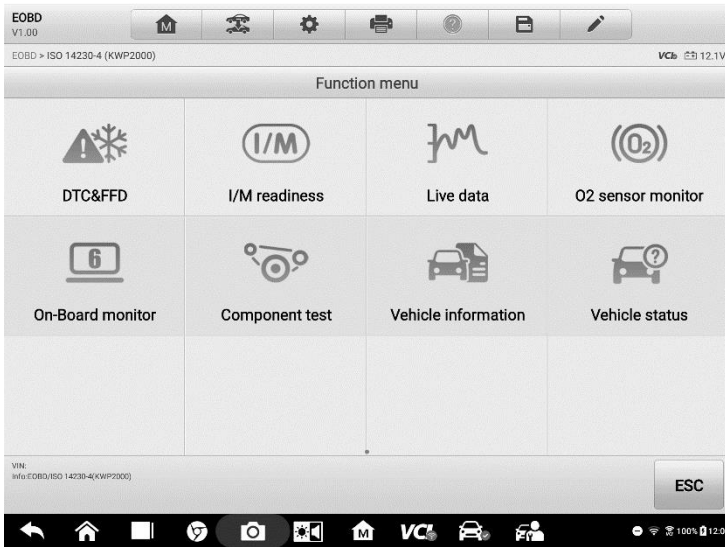

Figure 4-28 Sample OBD II Diagnostic Menu

4. Select a function option to continue.

- DTC & FFD
- I/M Readiness
- Live Data
- O2 Sensor Monitor
- On-Board Monitor
- Component Test
- Vehicle Information
- Vehicle Status

NOTE

Support functions may vary by vehicle.

4.11.2 Function Descriptions

This section describes the various functions of each diagnostic option:

4.11.2.1 DTC & FFD

When this function is selected, the screen displays a list of Current Codes and Pending Codes. When the Freeze Frame data of certain DTCs are available for viewing, a

snowflake button will display on the right side of the DTC item. The Erase Codes function can be applied by tapping the functional button at the bottom of the screen.

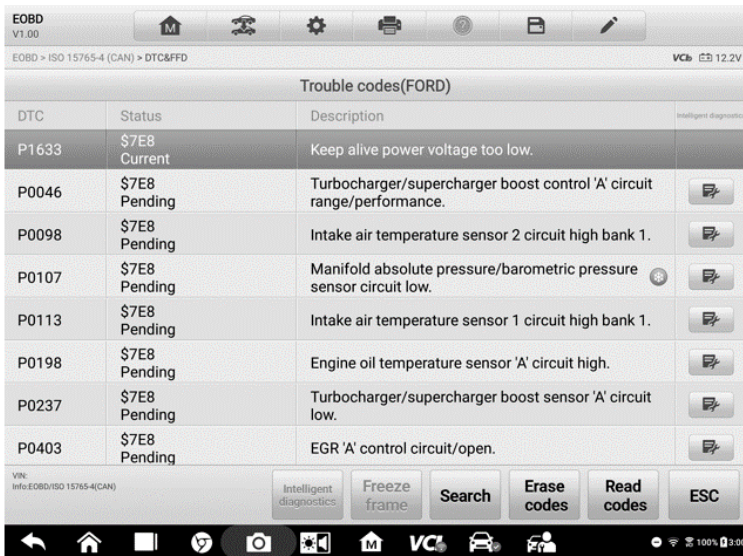

Figure 4-29 Sample DTC & FFD Screen

- **Current Codes**

Current codes are emission-related DTCs from the ECU of the vehicle. OBD II/EOBD Codes have a priority according to their emission severity, with higher-priority codes overwriting lower-priority ones. The priority of the code determines the illumination of the Malfunction Indicator Light (MIL) and the codes erase procedure. Manufacturers rank codes differently, so DTCs may vary by vehicle.

- **Pending Codes**

These are codes whose storing conditions have been met during the last drive cycle, but need to be met on two or more consecutive drive cycles before the DTC stored. The purpose of displaying pending codes is to assist the service technician after a vehicle repair when diagnostic information is cleared, by reporting test results after a single driving cycle.

- If a test fails during the driving cycle, the DTC associated is reported. If the pending fault does not occur again within 40 to 80 warm-up cycles, the fault is automatically cleared from memory.
- Test results reported do not necessarily indicate a faulty component or system. If test results indicate another failure after additional driving, a DTC is stored to indicate a faulty component or system.

- **Freeze Frame**

In most cases the stored frame is the last DTC reported. Certain DTCs, those that have a greater impact on vehicle emission, have a higher priority. In these cases, DTC of the highest priority is the one for which the freeze frame records are retained. Freeze frame data includes a “snapshot” of critical parameter values at the time the DTC is stored.

- **Erase Codes**

This option is used to clear all emission-related diagnostic data including DTCs, freeze frame data and specific manufacturer-enhanced data from the vehicle ECU. This option resets the I/M Readiness Monitor Status for all vehicle monitors to Not Ready or Not Complete status.

A confirmation screen displays when the clear codes option is selected to prevent accidental loss of data. Select **Yes** on the confirmation screen to continue, or **No** to exit.

4.11.2.2 I/M Readiness

This function is used to check the readiness of the monitoring system. It is an excellent function to use prior to having a vehicle inspected for state emissions compliance. Selecting I/M Readiness opens a submenu with two choices:

- Since DTCs Cleared – displays the status of monitors since the last time the DTCs are erased.
- This Driving Cycle – displays the status of monitors since the beginning of the current drive cycle.

4.11.2.3 Live Data

This function enables the display of real-time PID data from the ECU. Displayed data includes analog and digital input and output, and system status information broadcast in the vehicle data stream.

Live data can be displayed in various modes, see [Live Data](#) on page 38 for detailed information.

4.11.2.4 O2 Sensor Monitor

This function allows retrieval and review of recent O2 sensor monitor test results stored on the vehicle on-board computer.

The O2 Sensor Monitor test function is not supported by vehicles that communicate using a controller area network (CAN). For O2 Sensor Monitor tests results of CAN-equipped vehicles, refer to [On-Board Monitor](#).

4.11.2.5 On-Board Monitor

This function allows you to view the results of On-Board Monitor tests. The tests are useful after the service when a vehicle control module memory is already erased.

4.11.2.6 Component Test

This function enables dual-directional control of the ECU so that the diagnostic tool can transmit control commands to operate the vehicle systems. This function is useful in determining how well the ECU responds to a command.

4.11.2.7 Vehicle Information

This function enables the display of the vehicle identification number (VIN), calibration identification number, calibration verification number (CVN), and other information of the test vehicle.

4.11.2.8 Vehicle Status

This function checks the current condition of the vehicle, such as the communication protocols of OBD II modules, number of fault codes, and status of the Malfunction Indicator Light (MIL).

4.12 Diagnostic Report

4.12.1 Pre-Scan and Post-Scan

➤ To perform the pre-scan and post-scan functions

1. Auto SCAN the Vehicle - the Auto VID function can automatically identify the vehicle and its equipped systems. All available modules in all systems will be scanned automatically. Codes and code details will be listed.
2. Print Pre-SCAN Report - vehicle images can be taken with tablet and attached to SCAN report. The report file can be generated and submitted. The report can be customized with shop and vehicle information.
3. Repair Vehicle - creates efficient repair plan from the start.
4. Auto SCAN Repaired Vehicle - ensures no new faults were created during repair and no DTCs are present at completion.
5. Print Post-SCAN Report - proves all DTCs on Pre-SCAN report are fixed.

4.12.2 Diagnostic Report PDF

The diagnostic report can be reviewed, saved, and printed in multiple applications of the platform.

- a) Via the **History** function:

- Enter the Diagnosis main page, and tap **History** in the Top Toolbar.

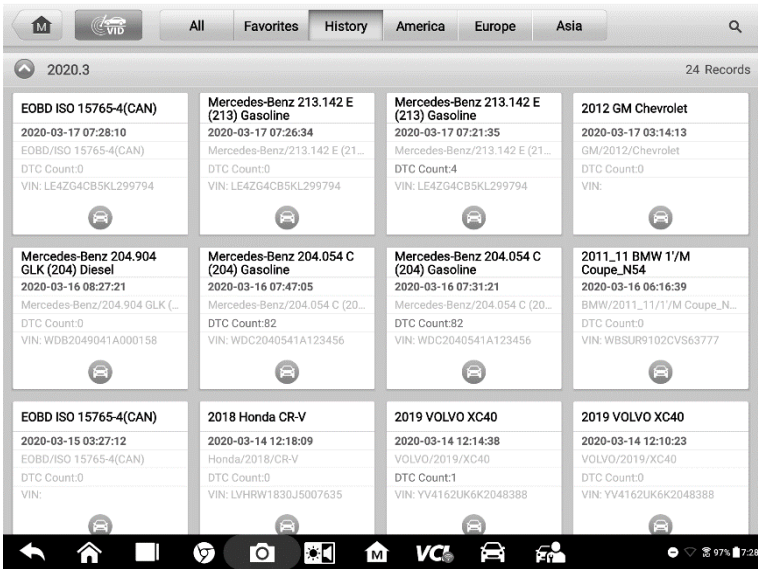

Figure 4-30 Sample History Screen

- Select a history record, and tap the **...** button in the upper right corner to view the PDF document, print, email or delete the historical test.

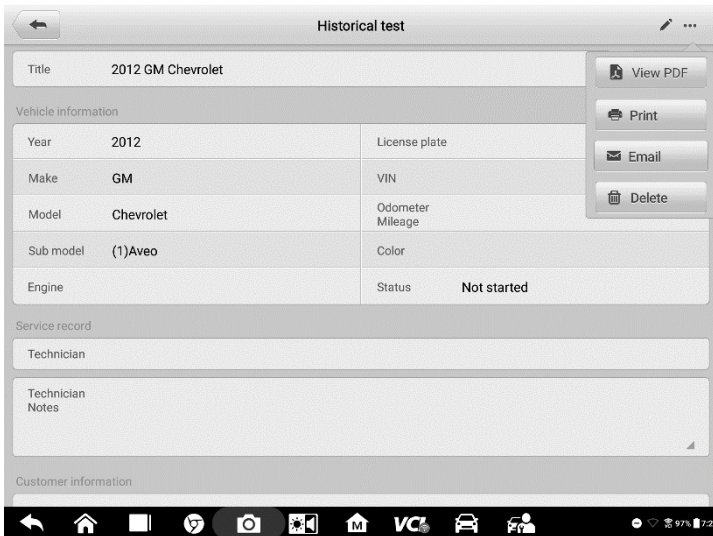

Figure 4-31 Sample Historical Test Screen

- b) Via the **Auto Scan** function:

- Enter the Auto Scan page and tap **Fault Scan** in the Functional Button Bar at the bottom of the screen.

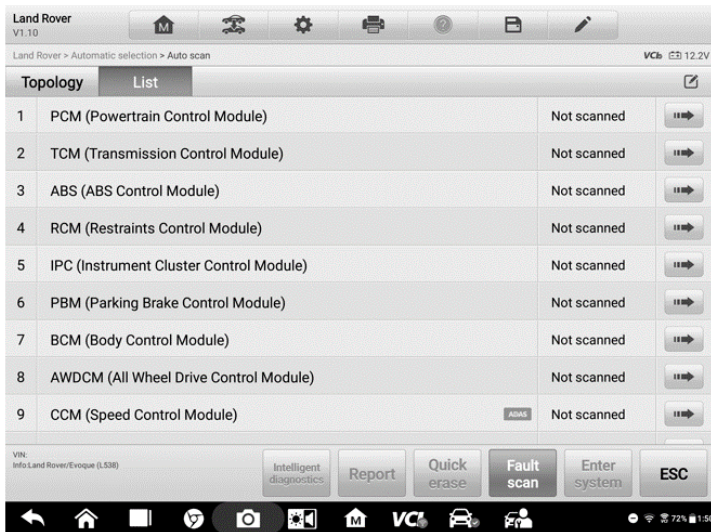

Figure 4-32 Sample Auto Scan Screen 1

- When the system scan is completed, tap **Report** in the Functional Button Bar at the bottom of the screen.

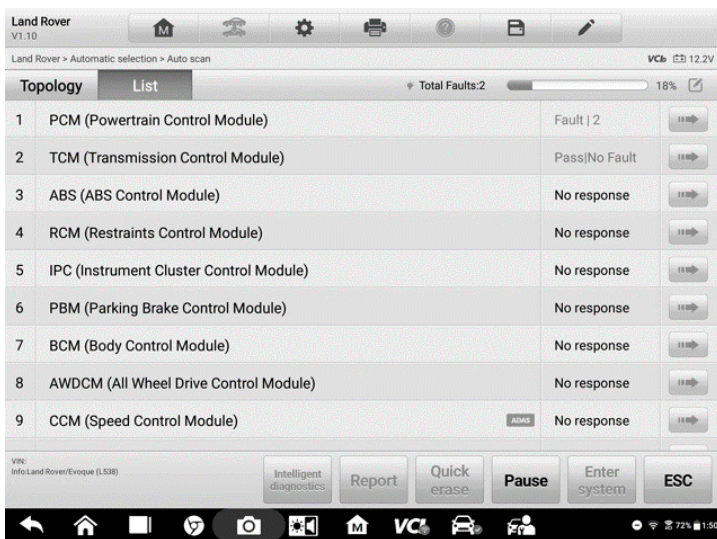



Figure 4-33 Sample Auto Scan Screen 2

- Tap the  button in the Diagnostics Toolbar, and select **Save all data** to save the PDF document or select **Save this page** to save the screenshot of the current

page.

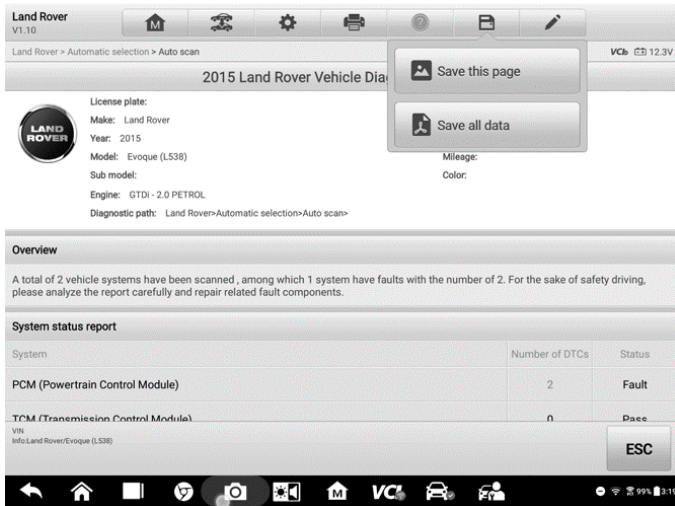

Figure 4-34 Sample Auto Scan Screen 3

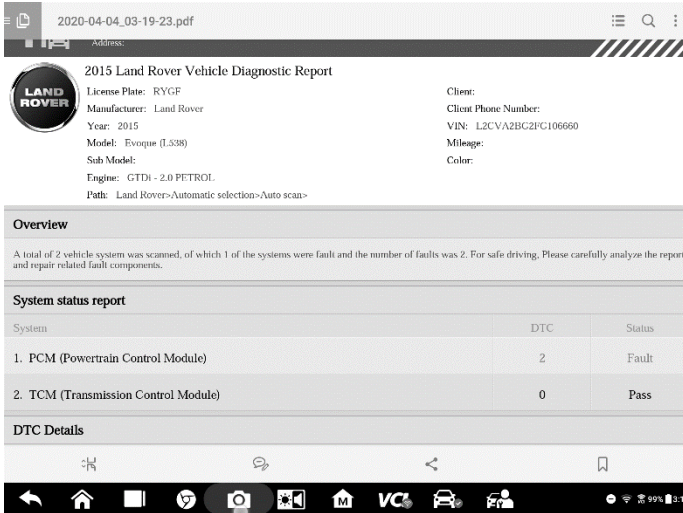



Figure 4-35 Sample PDF Document Screen

c) Via the functions of the Navigation Bar:

- The diagnostic report can also be viewed from such diagnostics function screens including Auto scan, Read codes, Live data, and Active test. Tap the  button in the Diagnostics Toolbar, and select **Save all data** to save the PDF document or select **Save this page** to save the screen shot of the current page.

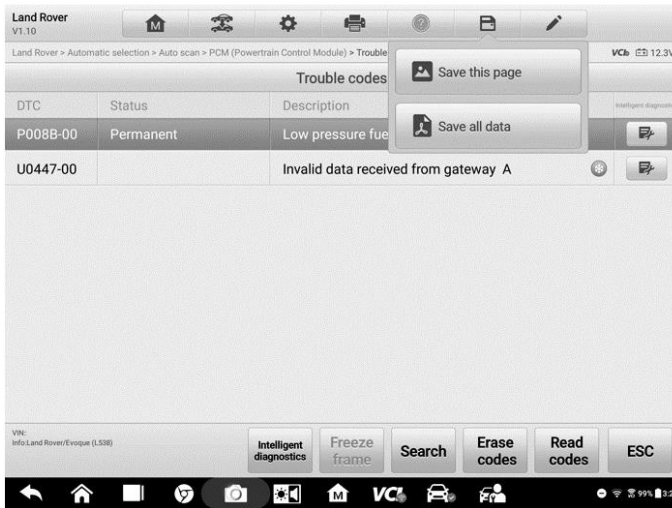

Figure 4-36 Sample Read Codes Screen

4.13 Exit Diagnostics

The Diagnostics application operates while communication with the vehicle is still active. It is important to properly exit from the diagnostics operation interface to stop all communications with the vehicle before closing the Diagnostics application.

NOTE

Damage to the vehicle electronic control module (ECM) may occur if communication is disrupted. Ensure all forms of communication links such as data cable, USB cable, and wireless or wired network, are properly connected throughout the test. Exit all interfaces before disconnecting the test cable and power supply.

➤ To exit the Diagnostics application

1. On an active diagnostic screen, tap the **Back** or **ESC** functional button to exit a diagnostic session; Or
2. Tap the **Vehicle Swap** button in the diagnostics toolbar to return to the Vehicle Menu screen.
3. On the vehicle menu screen, tap the **Home** button in the top toolbar; or tap the **Back** button in the navigation bar at the bottom of the screen. Or
4. Tap the **Home** button in the diagnostics toolbar to exit the application directly and return to the MaxiSys Job Menu.

Now, the Diagnostics application is no longer communicating with the vehicle and it is safe to open other MaxiSys applications, or exit the MaxiSys Diagnostic System and return to the Android System's Home screen

5 Intelligent Diagnostics

Intelligent Diagnostics is a specific fault code analysis function, with which you can access the most comprehensive and the latest code-specific data, DTC analysis, repair assist, repair tips, and relevant repair cases. It has been drawn from real world shop repair orders and records and with input from experienced industry professionals.

Intelligent Diagnostics adopts the scientific data cloud computing technology to match the specific fault code with the exact vehicle model. And the data has been thoroughly verified by automotive maintenance professionals.

The following are main parts of the code data contained in Intelligent Diagnostics:

1. Vehicle System and Detected DTC(s)
2. Technical Service Bulletin (OEM Information)
3. DTC Analysis
4. Repair Assist
5. Repair Tips
6. Component Measurement
7. Relevant Cases

NOTE

Before performing the Intelligent Diagnostics function, please ensure the network is connected successfully.

5.1 Accessing Intelligent Diagnostics Function

5.1.1 Auto Scan

Before starting Intelligent Diagnostics, please ensure that vehicle communication has been established. Connect the MaxiSys MS909 Diagnostic tablet to the test vehicle through the VCI device. For detailed directions to establish vehicle communication with the MaxiSys tablet, see [Establish Vehicle Communication](#).

Once communication has been established, enter the **Diagnostics** application and select the vehicle model. After a vehicle model is selected, tap **Auto Scan** from the **Main menu**. The **System list** screen will display. For detailed instructions on using the Auto scan function, see [Auto Scan](#).

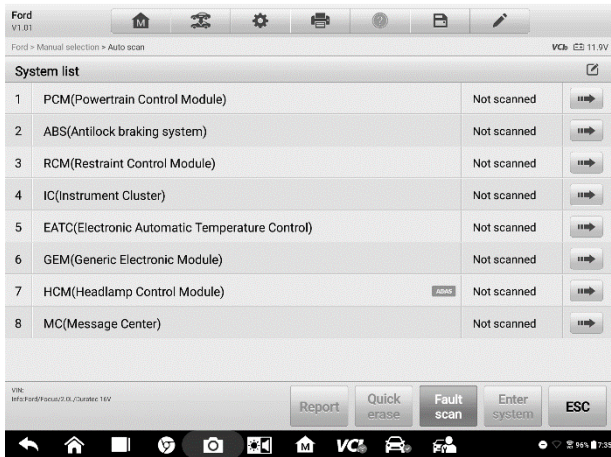

Figure 5-1 Sample System List Screen

For a number of vehicle brands, including Volkswagen, Audi, BMW, Ford, Land Rover, Jaguar, Chrysler, Fiat, Volvo, and more, a topology map is available to display the relationship between vehicle systems.

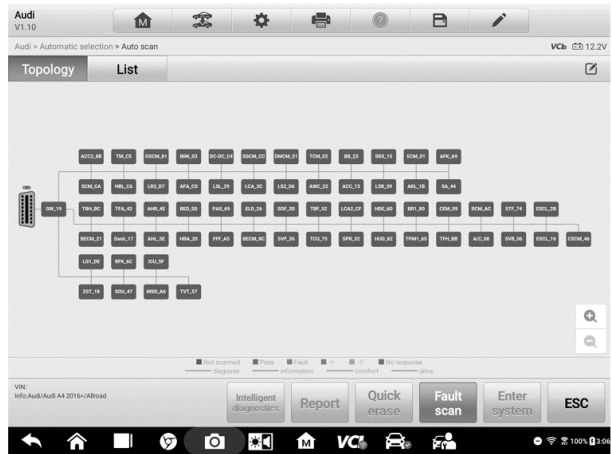

Figure 5-2 Sample Topology Display Screen

Select the **List** tab to display the vehicle systems as a list.

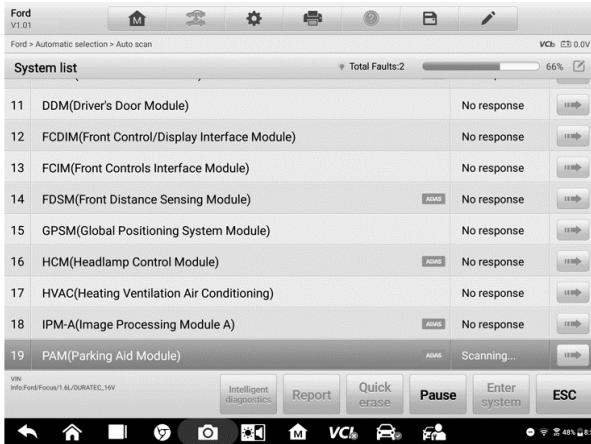

Figure 5-5 Sample Fault Scan on System List Screen 2

- On the **Topology** screen, a system with identified faults will display in orange, with the number of faults displayed in the upper right corner of the system icon. The number of total faults will display on the top.

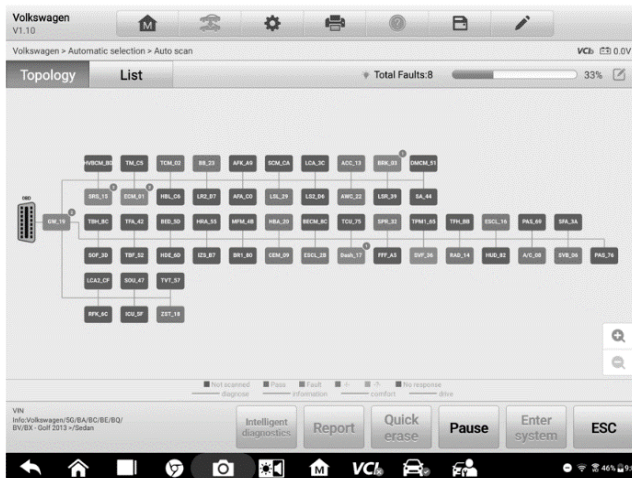

Figure 5-6 Sample Fault Scan on Topology Screen

- On the **List** screen, a system with identified faults will also display in red, with the number of faults on the right. The number of total faults will display on the top.

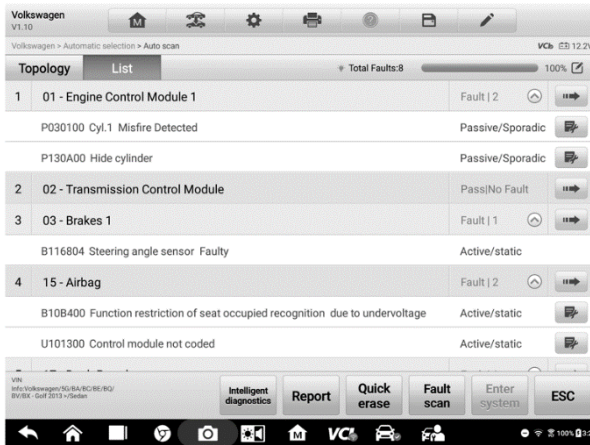



Figure 5-7 Sample Fault Scan on List Screen

After scanning system faults, there are two methods to access the Intelligent Diagnostics screen:

- Access via the **Intelligent Diagnostics button**  to view code-related information of all DTCs for the whole vehicle.
- Access via the **Intelligent Diagnostics icon**  to view code-related information of a specific DTC.

5.1.3 Access via Intelligent Diagnostics Button

After all the faults of the vehicle systems are scanned, tap the **Intelligent diagnostics button** on the lower corner of the screen to directly enter the Intelligent Diagnostics screen.

Entering the Intelligent Diagnostics screen, you can find the TSB, DTC analysis, repair assist and repair tips information of **All DTCs** for all the systems that have been scanned. For detailed operation instructions, please refer to the [Intelligent Diagnostics Operation](#) for details.

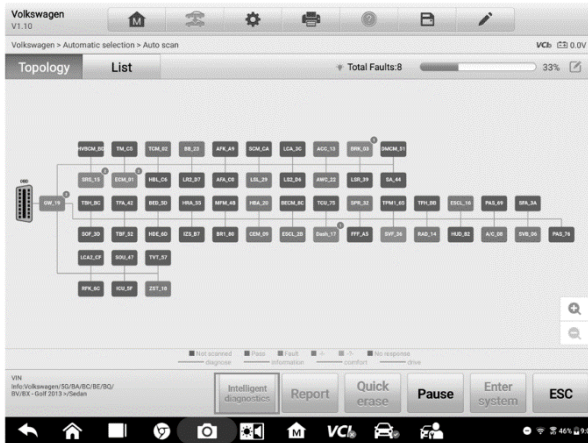

Figure 5-8 Sample Intelligent Diagnostics Button Screen

5.1.4 Access via Intelligent Diagnostics Icon

You can also use the **Intelligent Diagnostics icon** to enter the Intelligent Diagnostics function to get detailed fault repair instructions of a **specific DTC**.

The details of the detected fault(s), including the fault code, fault description and status, will be displayed right under the system name or module. If the Intelligent Diagnostics function is available for this vehicle, the **Intelligent Diagnostics icon** will display on the right.

On the **List** screen, tap the **Intelligent Diagnostics icon** on the right side to enter the Intelligent Diagnostics screen directly.

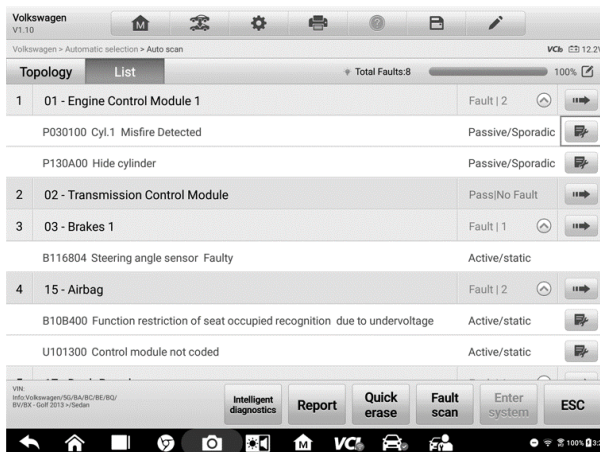

Figure 5-9 Sample Intelligent Diagnostics Icon Screen 1

Or on the **Topology** screen, once the system scan is complete, tap a system icon (displays in orange if faults are detected) to display complete system name with the Intelligent Diagnostics icon shown below. Tap the **Intelligent Diagnostics icon** to enter the Intelligent Diagnostics screen directly.

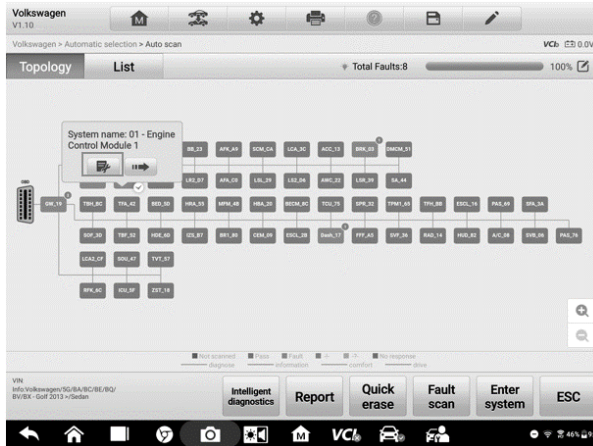



Figure 5-10 Sample Intelligent Diagnostics Icon Screen 2

When entering a specific system by tapping the arrow-shaped icon , you can also access the Intelligent Diagnostic screen if the Intelligent Diagnostics function is available for this vehicle.

- **To access the Intelligent Diagnostics screen after entering a specific system**
1. On the System list, Topology or List screen, tap the arrow icon  to enter a system, the Function menu will display. Available functions vary by vehicle.

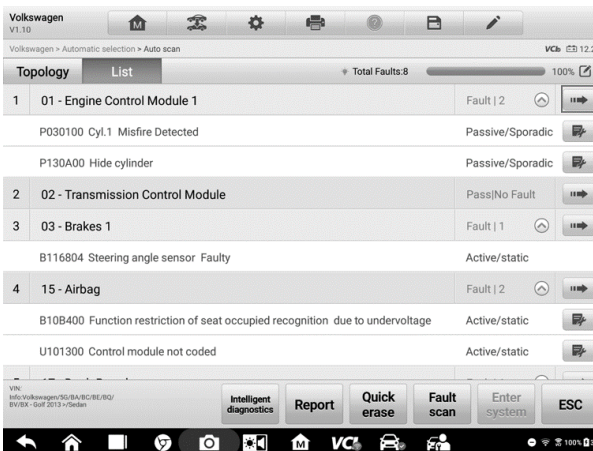

Figure 5-11 Sample Entering System Icon Screen (List)

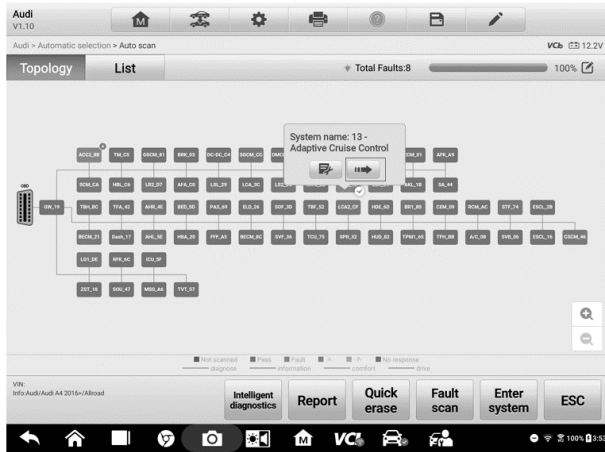

Figure 5-12 Sample Entering System Icon Screen (Topology)

2. Select **Trouble codes** from the Function menu screen and the trouble codes screen will display.

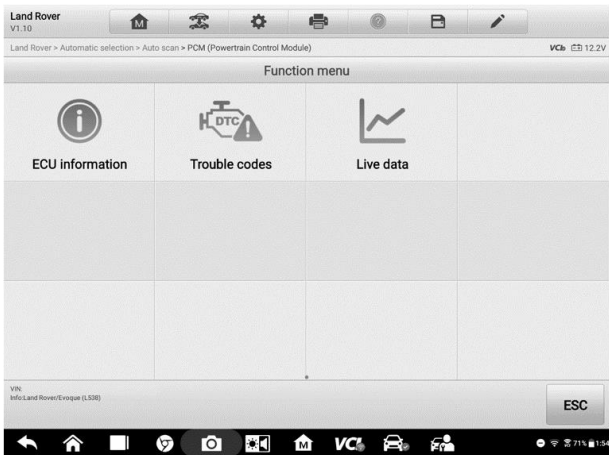



Figure 5-13 Sample Function Menu Screen

3. Tap the **Intelligent Diagnostics icon**  to the right of the DTC description. Or select a specific DTC from the DTC list, and then tap the **Intelligent Diagnostics button** at the bottom of the screen.

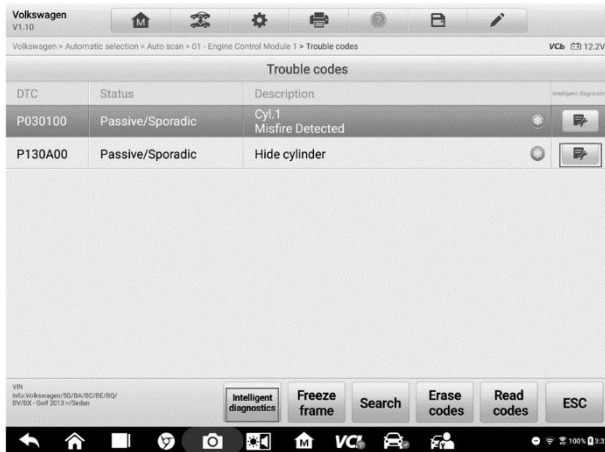

Figure 5-14 Sample Trouble Codes Screen

5.2 Intelligent Diagnostics Operation

Intelligent Diagnostics is an important and powerful function of MaxiSys MS909. It provides substantial information for intelligent diagnosis of the faults detected, offering Technical Service Bulletin, DTC Analysis, Repair Assist, Repair Tips, and Component Measurement to help you repair detected faults. It also provides relevant repair case information for viewing.

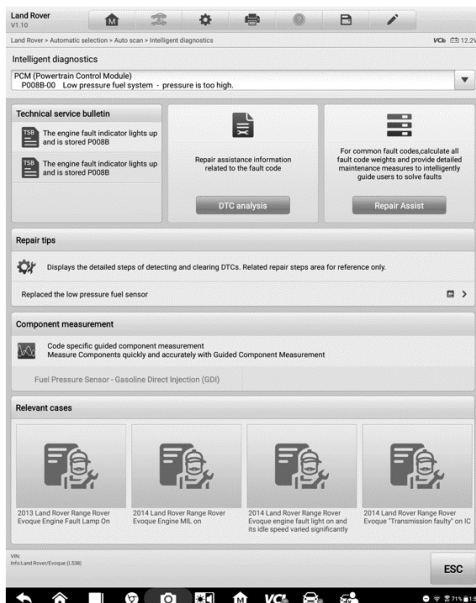

Figure 5-15 Sample Intelligent Diagnostics Layout

The **Intelligent Diagnostics** function consists of the following sections:

1. **Vehicle System and Detected DTC(s)** – displays the name of the vehicle system(s) and the detected DTC(s).
2. **Technical Service Bulletin** – contains DTC-related recalls, TSB, and OEM campaigns.
3. **DTC Analysis** – provides repair assistance information related to the fault code.
4. **Repair Assist** –intelligently prioritizes DTCs and leads the user to the proper repair.
5. **Repair Tips** – details the steps for determining and clearing faults.
6. **Component Measurement** – provides detailed information and instructional guides on using an oscilloscope to test components for faults.
7. **Relevant Cases** – offers relevant fault-clearing repair cases for reference.

5.2.1 Vehicle System and Detected DTC(s)

This section displays the scanned vehicle systems that contain faults. Tap the drop-down menu to view comprehensive information of ALL systems or switch to different fault codes for details.

Tap the arrow button on the right to display a drop-down list of all systems along with specific DTCs. Use your finger to touch and slide upward or downward on the screen to review all codes in the list. Select ALL systems or select a DTC to view the corresponding Intelligent Diagnostics information.

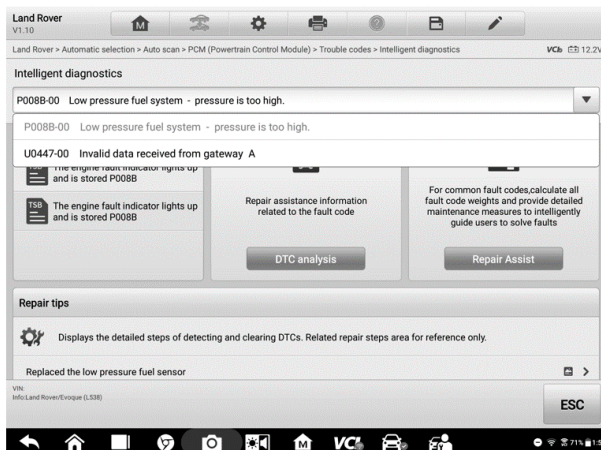

Figure 5-16 Sample Vehicle System and Detected DTC(s) Screen

5.2.2 Technical Service Bulletin (OEM Information)

The Technical Service Bulletin function matches the selected fault code with relevant vehicle manufacturer TSBs. All TSBs that relate to the selected DTC are listed in the TSB display window. Select a TSB to open the TSB page and view the TSB in details.

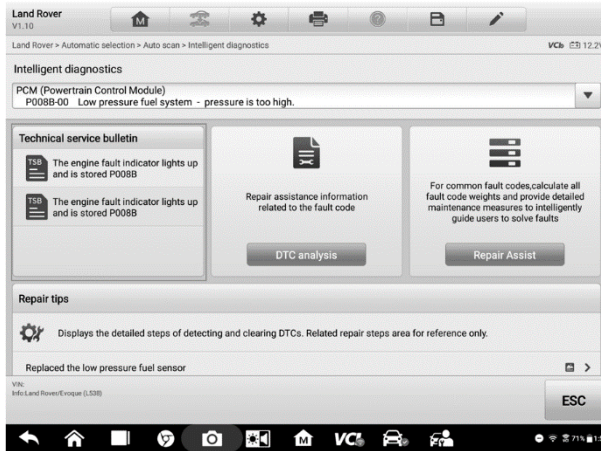

Figure 5-17 Sample TSB Screen

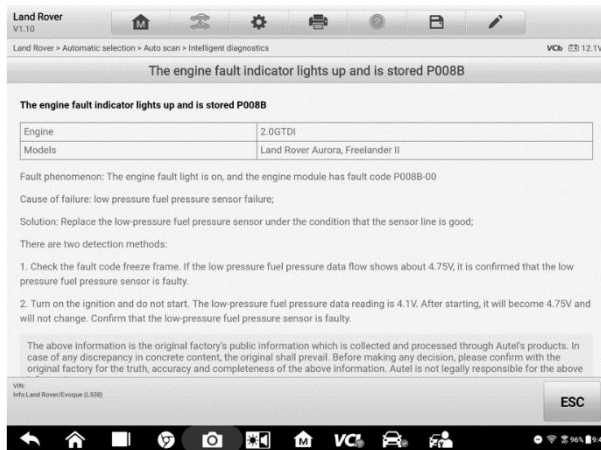

Figure 5-18 Sample TSB in Details

5.2.3 DTC Analysis

On the **Intelligent Diagnostic** screen, the DTC Analysis contains repair assistance and information related to the fault codes, including the fault description, condition, fault

influence, possible cause, and possible solution. The repair assistance information vary by vehicle.

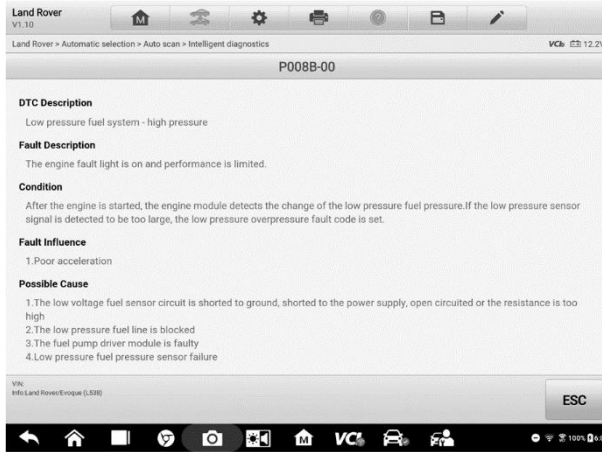

Figure 5-19 Sample DTC Analysis Screen

5.2.4 Repair Assist

The Repair Assist displays a list of items and their descriptions, completion status, and priorities. The higher the priority number is (1 is the highest), the earlier the related items should be tested.

➤ To perform Repair Assist

1. Tap **Repair Assist** button on the Intelligent Diagnostics screen to open the page.

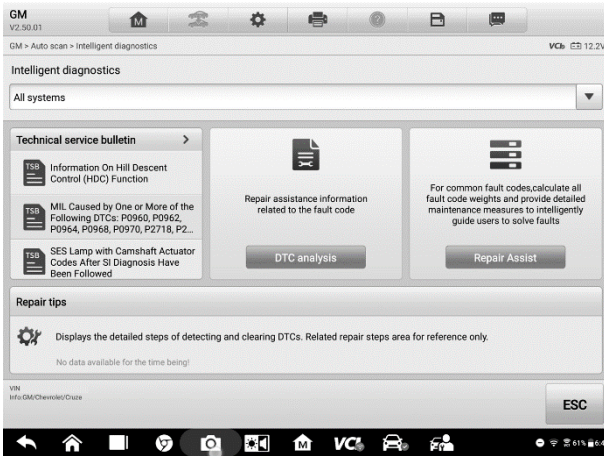



Figure 5-20 Sample Repair Assist Screen 1

2. Tap the **Run icon**  on the right to perform the selected item. Simply follow the screen prompts and make a series of choices.

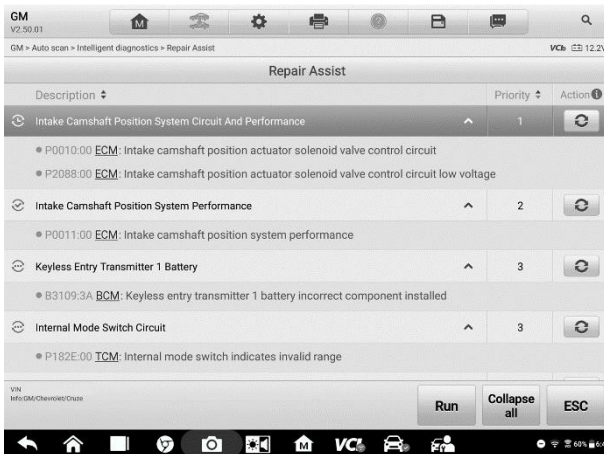





Figure 5-21 Sample Repair Assist Screen 2

Table 5-2 Completion Status in Repair Assist

| | | |
|-------------------------|---|---|
| <p>Completed</p> |  | <p>This indicates that all branches of the procedure are completed.</p> |
|-------------------------|---|---|

| | | |
|---------------------------|---|--|
| <p>Uncompleted</p> |  | <p>This indicates that certain branches of the procedure is uncompleted.</p> |
| <p>Not running</p> |  | <p>This indicates that no branch of the procedure has run.</p> |

3. Tap the **Continue** button to go to the next step. Please note that when there are more than one DTCs in Select Branch, the ones that have run would be highlighted in blue.

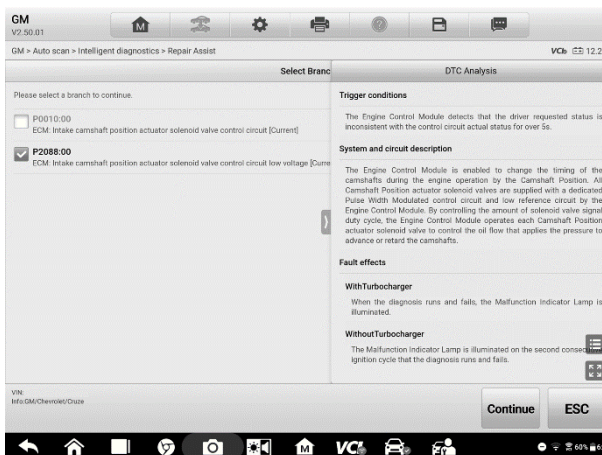



Figure 5-22 Sample Repair Assist Screen 3

NOTE

In some cases, you need to tap this icon  to fold the right column so that the whole interface of Select Branch can be shown.

4. In this repair process, it may integrate one or more diagnostic functions such as Read Codes, Erase Codes, Live Data, Freeze Frame and Active Test as needed.

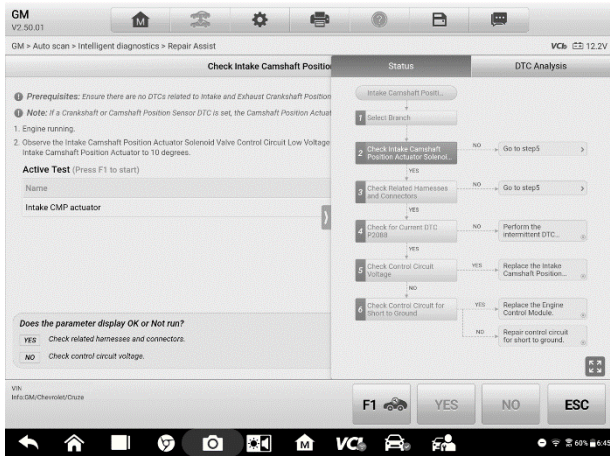

Figure 5-23 Sample Repair Assist Screen 4

5. In some cases, it is necessary to check the circuits. Take **Figure 5-24** for example, tap the first **Link icon** to open the *Location Diagram*, and it will show the location of the component *Intake Camshaft Position Actuator Solenoid Valve* in the car.

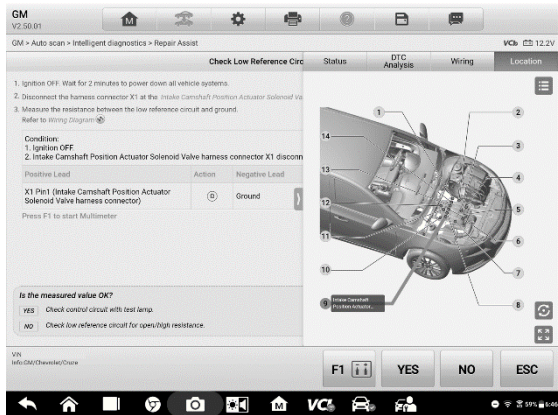

Figure 5-24 Sample Repair Assist Screen 5

6. Tap the second **Link icon** to open the *Wiring Diagram* to locate the related wirings. Tap the legend button in the upper right corner, and you will be able to locate the components, connectors, wiring, and ground electrodes by tapping the names in the list when necessary.

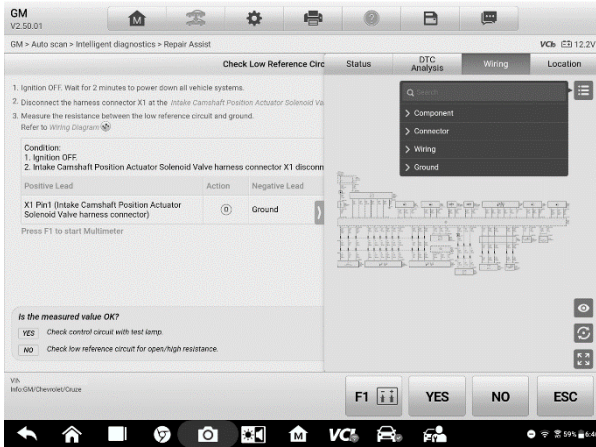



Figure 5-25 Sample Repair Assist Screen 6

7. If you want to view details of the connector, tap the **Link icon**  before the names in the list, then you will see the picture.

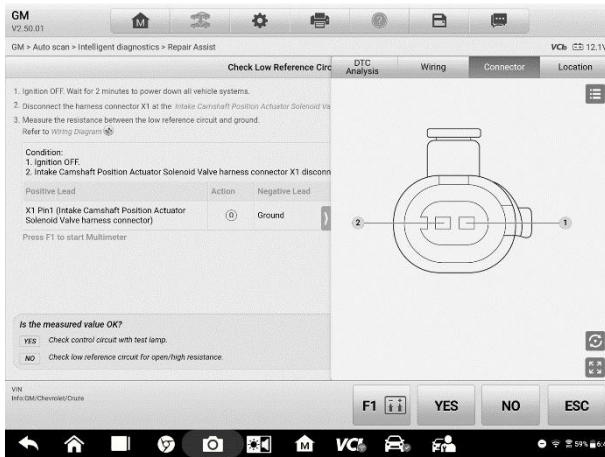











Figure 5-26 Sample Repair Assist Screen 7

8. Measure the resistance/voltage/current between the two pins according to the prompts in the multimeter to see if the measured value is ok or not.

 **NOTE:** If you have connected to a VCMI device, tap F1 button to start measurement directly.

2. Tap this button  to switch to the last one or tap this button  to switch to the next one.
3. Tap this button  to find what you have previously viewed.
4. Tap this button  to hide the unrelated wires, and tap this button  to show the hidden wires.
5. Tap this button  to restore the initial settings.
6. Tap this button  to exit the full screen, and tap this button  to enter the full screen.

5.2.5 Repair Tips

The Repair Tips function displays a range of diagnostic and repair steps, including the information needed in order to clear the faults. The repair steps are provided in text and video.



Figure 5-29 Sample Repair Tips Description 1 (Text)

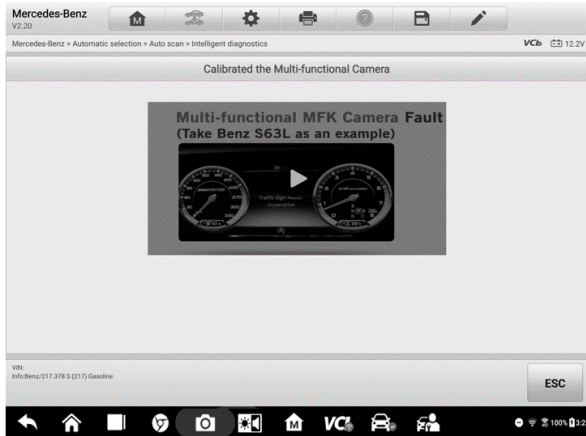

Figure 5-30 Sample Repair Tips Description 2 (Video)

5.2.6 Component Measurement

The component measurement section directs technicians to oscilloscope in one click. This section may include relevant waveforms and waveform analysis to aid the technician in diagnostics and repairs.

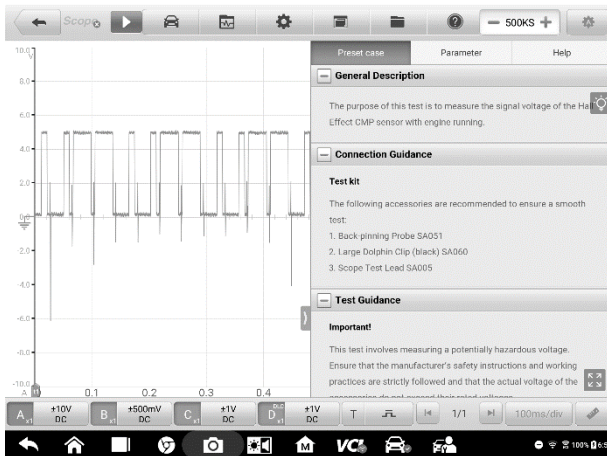

Figure 5-31 Sample Component Measurement Screen

NOTE

To run the oscilloscope for measuring components, connect the tablet to a VCMI device. Connection to a VCI device can only provide information on related waveforms and waveform analysis.

5.2.7 Relevant Cases

This section offers recommended repair cases that may be relevant to the current vehicle and/or the current fault. These repair cases may provide greater insight into diagnosing and repairing your vehicle. Tap the relevant cases to review.



Figure 5-32 Sample Relevant Cases Screen

- **To review relevant cases information**
 1. Tap the **Relevant Cases** icon to display main page.
 2. Scroll through the page and to locate relevant information.
 3. Tap the arrow icon at the left top and return to the previous repair case page.

6 Service

The **Service** section is specially designed to provide quick access to the vehicle systems for various scheduled service and maintenance tasks. The typical service operation screen is a series of menu driven executive commands. Follow on-screen instructions to select appropriate execution options, enter correct values or data, and perform necessary actions. The application will display detailed instructions to complete selected service operations.

After entering each special function, the screen will display two application choices: **Diagnosis** and **Hot Functions**. The **Diagnosis** enables the reading and clearing of codes which is sometimes necessary after completing certain special functions. **Hot Functions** consists of sub functions of the selected special function.

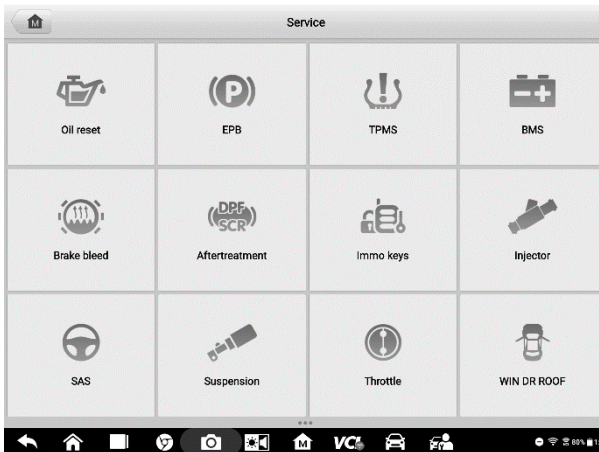

Figure 6-1 Sample Service Menu

Several most commonly used services are described in this chapter.

6.1 Oil Reset Service

Perform reset for the Engine Oil Life system, which calculates an optimal oil life change interval depending on the vehicle driving conditions and climate. The Oil Life Reminder must be reset each time the oil is changed, so the system can calculate when the next oil change is required.

NOTE

1. Always reset the engine oil life to 100% after every oil change.
 2. All required work must be carried out before the service indicators are reset. Failure to do so may result in incorrect service values and cause DTCs to be stored by the relevant control module.
 3. For some vehicles, the scan tool can reset additional service lights such as maintenance cycle and service interval. On BMW vehicles for example, service resets include engine oil, spark plugs, front/rear brakes, coolant, particle filter, brake fluid, micro filter, vehicle inspection, exhaust emission inspection and vehicle checks.
-

6.2 Electric Parking Brake (EPB) Service

This function has a multitude of usages to maintain the electronic braking system safely and effectively. The applications include deactivating and activating the brake control system, assisting with brake fluid control, opening and closing brake pads, and setting brakes after disc or pad replacement.

6.2.1 EPB Safety

It can be dangerous to perform Electric Parking Brake (EPB) system maintenance, so before you begin the service work, please keep these rules in mind.

- ✓ Ensure that you are fully familiar with the braking system and its operation before commencing any work.
- ✓ The EPB control system may be required to be deactivated before carrying out any maintenance/diagnostic work on the brake system. This can be done from the tool menu.
- ✓ Only perform maintenance work when the vehicle is stationary and on level ground.
- ✓ Ensure that the EPB control system is reactivated after the maintenance work has been completed.

NOTE

Autel accepts no responsibility for any accident or injury arising from the maintenance of the Electric Parking Brake system.

6.3 Tire Pressure Monitoring System (TPMS) Service

This function allows you to quickly look up the tire sensor IDs from the vehicle ECU, as well as to perform TPMS replacement and reset procedures after tire sensors are replaced.

6.4 Battery Management System (BMS) Service

The Battery Management System (BMS) allows the tool to evaluate the battery charge state, monitor the close-circuit current, register the battery replacement, activate the rest state of the vehicle, and charge the battery via the diagnostic socket.

NOTE

1. This function is not supported by all vehicles.
2. The sub functions and actual test screens of the BMS may vary by vehicle, please follow the on-screen instructions to make correct option selection.

The vehicle may use either a sealed lead-acid battery or an Absorbed Glass Mat (AGM) battery. Lead acid battery contains liquid sulphuric acid and can spill when overturned. AGM battery (known as VRLA battery, valve regulated lead acid) also contains sulphuric acid, but the acid is contained in glass mats between terminal plates.

It is recommended that the replacement aftermarket battery has the same specifications, such as capacity and type, as the exiting battery. If the original battery is replaced with a different type of battery (e.g. a lead-acid battery is replaced with an AGM battery) or a battery with a different capacity (mAh), the vehicle may require reprogramming of the new battery type, in addition to, performing the battery reset. Consult the vehicle manual for additional vehicle-specific information.

6.5 Diesel Particle Filter (DPF) Service

The Diesel Particle Filter (DPF) function manages DPF regeneration, DPF component replacement teach-in and DPF teach-in after replacing the engine control unit.

The ECM monitors driving style and selects a suitable time to employ regeneration. Cars driven a lot at idling speed and low load will attempt to regenerate earlier than cars driven more with higher load and speed. For regeneration to take place, a prolonged high exhaust temperature must be obtained.

In the event of the car being driven in such a way that regeneration is not possible, i.e., frequent short journeys, a diagnostic trouble code will eventually be registered in addition to the DPF light and “Check Engine” indicators displaying. A service regeneration can be requested in the workshop using the diagnostic tool.

Before performing a forced DPF regeneration using the tool, check the following items:

- The fuel light is not on.
- No DPF-relevant faults are stored in system.
- The vehicle has the specified engine oil.
- The oil for diesel is not contaminated.

! IMPORTANT

Before diagnosing the problem vehicle and attempting to perform an emergency regeneration, it is important to obtain a full diagnostic log and read out relevant measured value blocks.

🔧 NOTE

1. The DPF will not regenerate if the engine management light is on, or there is a faulty EGR valve.
 2. The ECU must be re-adapted when replacing the DPF and when topping up the fuel additive Eolys.
 3. If the vehicle needs to be driven in order to perform a DPF service, a second person is needed for the function. One person should drive the vehicle while the other person observes the screen on the Tool. Do not attempt to drive and observe the scan tool at the same time. This is dangerous and puts your life and the lives of other motorists and pedestrians at risk.
-

6.6 Immobilizer (IMMO) Service

An immobilizer is an anti-theft mechanism that prevents an automobile's engine from starting unless the correct ignition key or other device is present. This device prevents thieves from starting the car by a method known as hot wiring. Most new vehicles have an immobilizer as standard equipment. An important advantage of this system is that it doesn't require the car owner to activate it; it operates automatically. An immobilizer is considered as providing much more effective anti-theft protection than an audible alarm alone; many auto insurance companies offer lower rates for vehicles that are equipped with an immobilizer.

As an anti-theft device, an immobilizer disables one of the systems needed to start a car's engine, usually the fuel supply or the ignition. This is accomplished by radio frequency identification between a transponder in the ignition key and a device called a radio frequency reader in the steering column. When the key is placed in the ignition, the transponder sends a signal with a unique identification code to the reader, which relays it to a receiver in the vehicle computer control module. If the code is correct, the computer allows the fuel supply and ignition systems to operate and start the car. If the code is incorrect or absent, the computer disables the system, and the car will be unable to start until the correct key is placed in the ignition.

The IMMO service can disable a lost vehicle key and program the replacement key fob. One or more replacement key fobs can be programmed.

6.7 Steering Angle Sensor (SAS) Service

SAS Calibration permanently stores the current steering wheel position as the straight-ahead position in the SAS EEPROM. Therefore, the front wheels and the steering wheel must be set exactly to the straight-ahead position before calibration. In addition, the VIN is also read from the instrument cluster and stored permanently in the SAS EEPROM. On successful completion of calibration, the SAS fault memory is automatically cleared.

Calibration must always be carried out after the following operations:

- Steering wheel replacement
- SAS replacement
- Any maintenance that involves opening the connector hub from the SAS to the column
- Any maintenance or repair work on the steering linkage, steering gear or other related mechanism
- Wheel alignment or wheel track adjustment
- Accident repairs where damage to the SAS or assembly, or any part of the steering system may have occurred

NOTE

1. Autel accepts no responsibility for any accident or injury arising from servicing the SAS system. When interpreting DTCs retrieved from the vehicle, always follow the manufacturer's recommendation for repair.
 2. All software screens shown in this manual are examples, and actual test screens may vary by test vehicle. Pay attention to the menu titles and onscreen instructions to make correct option selections.
 3. Before starting procedure, make sure the vehicle has an ESC button. Look for button on dash.
-

7 Data Manager

The Data Manager application allows you to store, print, and review the saved files, manage the workshop information, customer information records and keep test vehicle records.

Selecting the Data Manager application opens the file system menu. There are eight main functions available.

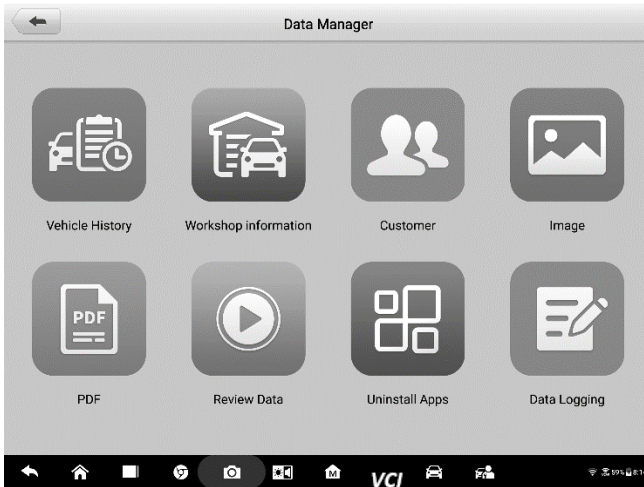





Figure 7-1 Sample Data Manager Main Screen

The table below describes each of the functional buttons in the Data Manager application.

Table 7-1 Buttons in Data Manager

| Name | Button | Description |
|-----------------------------|--------|---|
| Vehicle History | | Tap to view the diagnostic records. |
| Workshop Information | | Tap to view or edit the workshop information. |
| Customer | | Tap to create a new customer account file. |
| Image | | Tap to view the screenshots. |
| PDF | | Tap to view the diagnostic reports. |

| Name | Button | Description |
|----------------|---|--|
| Review Data |  | Tap to view the recorded data. |
| Uninstall Apps |  | Tap to uninstall applications. |
| Data Logging |  | Tap to view communications with Autel support service and ECU information of the test vehicle. The saved data can be reported and sent to the technical center via the Internet. |

7.1 Vehicle History

This function stores records of test vehicle history, including vehicle information and the retrieved DTCs from previous diagnostic sessions. Test information is summarized and displays in an easy-to-read table listing. The Vehicle History also provides direct access to the previously tested vehicle and allows you to directly restart a diagnostic session without needing to perform auto or manual vehicle selection.

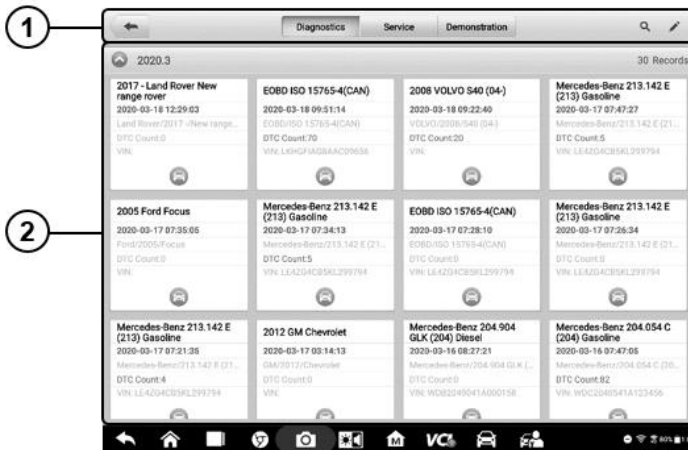

Figure 7-2 Sample Vehicle History Screen

1. Top Toolbar Buttons – navigation and application controls.
 2. Main section – displays all the vehicle records.
- **To activate a test session for the recorded vehicle**
1. Tap **Data Manager** on the MaxiSys Job Menu.
 2. Select **Vehicle History** to open the screen. Tap **Diagnostics** or **Service** to select diagnostic test records or service test records.

3. Tap **Diagnostics** icon at the bottom of the thumbnail of a vehicle record item.
4. The Diagnostics screen of the vehicle displays and a new diagnostic session is activated, see [Diagnostics](#) for detailed instructions on vehicle diagnostic operations.
Or,
5. Select a vehicle thumbnail to select record. A History Test record sheet displays. Review the recorded information of the test vehicle, and tap the **Diagnostics** button on the upper right corner to continue diagnostics.

7.1.1 Historical Test Record

The Historical Test is a detailed data form of the tested vehicle, which includes general vehicle information, service record, customer information, and the diagnostic trouble codes retrieved from the previous test sessions. Technician Notes will also display if present.

NOTE

The MaxiSys tablet must establish connection to the VCI to restart test sessions on the previously tested vehicles.

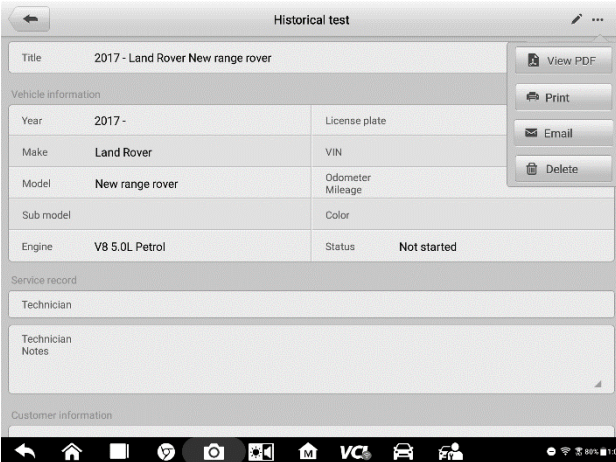

| Title | | 2017 - Land Rover New range rover | |
|----------------------|-----------------|-----------------------------------|-------------|
| Vehicle information | | | |
| Year | 2017 - | License plate | |
| Make | Land Rover | VIN | |
| Model | New range rover | Odometer Mileage | |
| Sub model | | Color | |
| Engine | V8 5.0L Petrol | Status | Not started |
| Service record | | | |
| Technician | | | |
| Technician Notes | | | |
| Customer information | | | |

Figure 7-3 Sample Historical Test Record Sheet

➤ To edit the Historical Test record

1. Tap **Data Manager** in the MaxiSys main screen.
2. Select **Vehicle History**.
3. Select the specific vehicle history record thumbnail from the main section. The historical test record will display.
4. Tap the **Edit** button (a pen icon) to start editing.
5. Tap each item to input information or attach files or images.

6. Tap **Add a Customer** to correlate the historical record sheet to an existing customer account, or add a new account to be correlated with the test vehicle record. See [7.3 Customer](#) on page 89 for more information.
7. Tap **Done** to save the updated record, or tap **Cancel** to exit without saving.

NOTE

The vehicle VIN, license number and customer account are correlated by default. Vehicle records will automatically be correlated using this vehicle and customer identification.

7.2 Workshop Information

Workshop Information allows you to input, edit, and save the detailed workshop information, such as shop name, address, phone number and other remarks, which, when printing vehicle diagnostic reports and other associated test file, will display as the header of the printed documents.

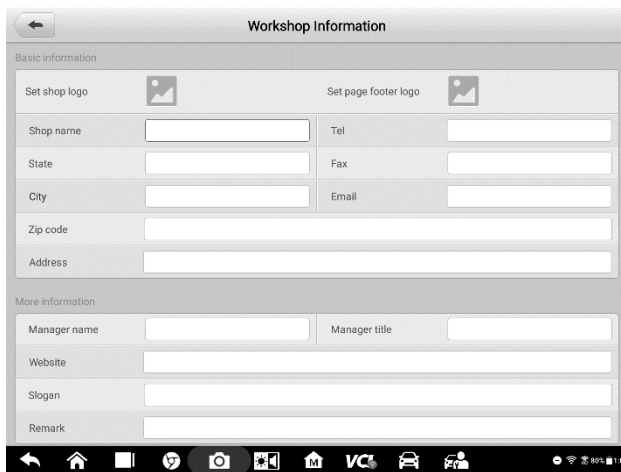

Figure 7-4 Sample Workshop Information Sheet

➤ **To edit the Workshop information sheet**

1. Tap **Data Manager** in the MaxiSys Main Screen.
2. Select **Workshop Information**.
3. Tap on each field to input the corresponding information.
4. Tap **Done** to save the updated workshop information, or tap **Cancel** to exit without saving.

7.3 Customer

The Customer function allows you to create and edit customer accounts. It helps you to save and organize all customer accounts correlated with the test vehicle history records.

➤ **To create a customer account**

1. Tap the **Data Manager** application in the MaxiSys main screen.
2. Select **Customer**.
3. Tap the **Add a customer** button. An empty information form displays, tap each field to input the appropriate information.

🔍 **NOTE**

The items that must be filled are indicated as required fields.

4. For customers with more than one vehicle for service, tap **Add New Vehicle Information**. To delete the added vehicle information, tap the ✕ button.
5. Tap **OK** in the upper right corner of the screen to save the customer information, or tap **Cancel** to exit without saving.

➤ **To edit a customer account**

1. Tap **Data Manager** on the MaxiSys Job Menu.
2. Select **Customer**.
3. Select a customer account by tapping the corresponding name card. A Customer Information record displays.
4. Tap **Edit** on the top toolbar to start editing.
5. Tap on the input field to edit or amend information, and enter updated information.
6. Tap **Complete** to save the updated information, or tap **Cancel** to exit without saving.

➤ **To delete a customer account**

1. Tap **Data Manager** on the MaxiSys Job Menu.
2. Select **Customer**.
3. Select a customer account by tapping the corresponding name card. A Customer Information record displays.
4. Tap **Edit** on the top toolbar to start editing.
5. Tap **Delete** button on the top of the screen. A reminder message displays.
6. Tap **OK** to confirm the command, and the account is deleted. Tap **Cancel** to cancel the request.

7.4 Image

The Image section is a PNG database containing all captured screenshots.

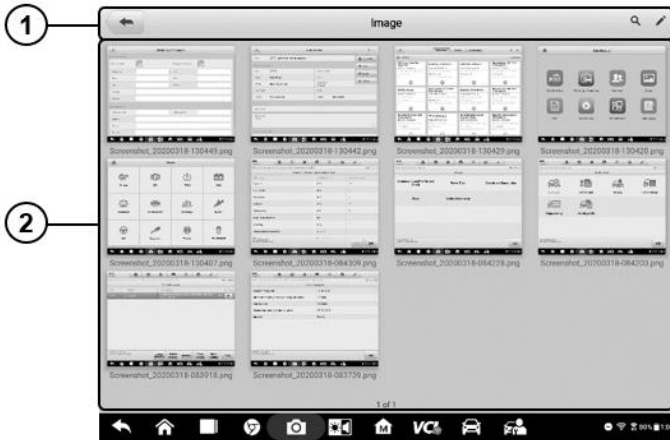

Figure 7-5 Sample Image Database Screen

1. **Toolbar Buttons** – used to edit, print or delete the image files. See [Table 7-2 Toolbar Buttons in PNG Database](#) on page 90 for detailed information.
2. **Main Section** – displays the stored images.

Table 7-2 Toolbar Buttons Description

| Name | Button | Description |
|---------------|--------|--|
| Back | | Return to the previous screen. |
| Search | | Tap to enter the search page. |
| Edit | | Tap to display the editing toolbar to print, delete or view image. |
| Cancel | | Tap to close the editing toolbar or cancels file search. |
| Search | | Quickly searches the image by entering the time of the screenshot. |
| Print | | Tap to print the selected image. |
| Delete | | Tap to delete the selected image. |
| Email | | Tap to send the selected image to an email. |

➤ **To edit/delete image(s)**

1. Select **Data Manager** from the MaxiSys Job Menu.
2. Select **Image** to access the PNG database.
3. Tap **Edit** on the top right corner of the window. The editing screen displays.

4. Select the image(s) you want to edit by tapping the check box at the bottom right corner of the image.
5. Tap **Delete** icon to delete the selected images or delete all images. Tap **Print** icon to print the selected image(s). Tap **Email** icon to send the selected image(s) to an email.

7.5 PDF Files

The PDF section stores and displays all PDF files of saved data. After entering the PDF database, select a PDF file to view the stored information.

This section uses the standard Adobe Reader application for file viewing and editing. Please refer to the associated Adobe Reader manual for more detailed instructions.

7.6 Review Data

The Review Data function allows you to playback the recorded data frames of live data streams.

On the Review Data main screen, select a record file to playback.

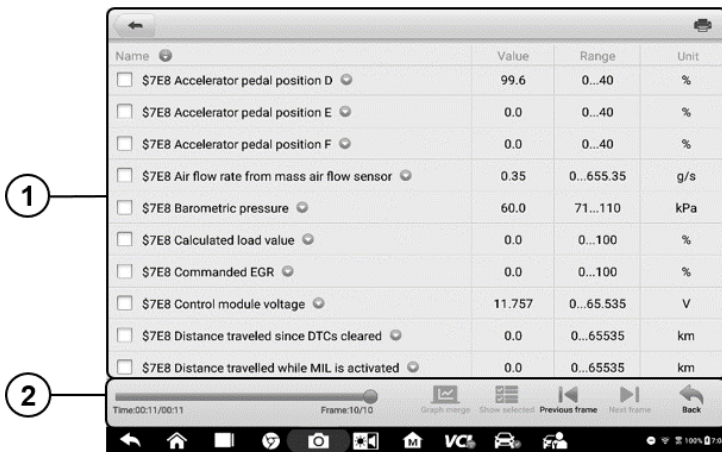

Figure 7-6 Sample Data Playback Screen

1. Main Section – displays the recorded data frames.
2. Navigation Toolbar – allows you to manipulate data playback.

Use the Navigation Toolbar buttons to playback the record data from frame to frame.

Tap **Back** to exit data playback.

7.7 Uninstall Apps

This section allows you to manage the firmware application installed on the MaxiSys Diagnostics System. Selecting this section opens a managing screen, on which you can check all the available vehicle diagnostic applications.

Select the vehicle firmware you want to delete by tapping on the car brand icon, the selected item will display a blue check mark at the upper right corner. Tap the **Delete** button on the top bar to delete the firmware from the system database.

7.8 Data Logging

The Data Logging section allows you to launch the Support platform directly to view all records of all feedback or not feedback (saved) data loggings on the diagnostic system. For more information, please refer to [Data Logging](#) on Page 108.

8 Settings

Access the Settings menu to adjust default setting and view information about the MaxiSys system. The following options are available for the MaxiSys system settings:

- Unit
- Language
- Printing settings
- Notification center
- Auto update
- ADAS registration
- Vehicle list
- Country code
- System settings
- About

8.1 Operations

This section describes the operation procedures for the settings.

8.1.1 Unit

This option allows you to change the measurement unit for the diagnostic system.

➤ To change the unit setting

1. Tap the **Settings** application on the MaxiSys Job Menu.
2. Tap the **Unit** option on the left column.
3. Select the appropriate measurement unit, Metric or English. A check mark displays to the right of the selected unit.
4. Tap the **Home** button on the top left corner to return to the MaxiSys Job Menu. Or select another setting option for the system setup.

8.1.2 Language

This option allows you to change the display language for the MaxiSys system.

- **To adjust the language setting**
 1. Tap the **Settings** application on the MaxiSys Job Menu.
 2. Tap the **Language** option on the left column.
 3. Select the appropriate language. A check mark displays to the right of the selected language.
 4. Tap the **Home** button on the top left corner to return to the MaxiSys Job Menu. Or select another setting option for the system setup.

8.1.3 Printing Settings

Printing Setting

This option allows you to print from the tablet to a network printer via a computer.

- **To setup the printer connection**
 1. Tap **Settings** on the MaxiSys Job Menu.
 2. Tap **Printing Settings** on the left column.
 3. Tap **Print via Network** to activate the printing function, which enables the device to send files to the printer through the PC via Wi-Fi or Ethernet connection.
 4. Tap **Home** on the top left corner to return to the MaxiSys Job Menu. Or select another setting option for the system setup.

Printing Operations

- **To install the MaxiSys Printer driver program**
 1. Download **Maxi PC Suite** from www.autel.com > *Support* > *Downloads* > *Autel Update Tools*, and install to your Windows-based PC.
 2. Double-click on **Setup.exe**.
 3. Select an installation language and the wizard will load.
 4. Follow the instructions on the screen and click on **Next** to continue.
 5. Click **Install** and the printer driver program will be installed on to the computer.
 6. Click **Finish** to complete the installation.

NOTE

The MaxiSys printer runs automatically after the installation.

This section describes how to receive files from the MaxiSys tablet and perform printing through the computer:

- **To perform printing through the computer**

1. Make sure the tablet is connected to the computer network, via Wi-Fi or LAN, before printing.
2. Run the **MaxiSys Printer** program on the computer.
3. Click **Test Print** to check whether the printer works properly.
4. Tap the **Print** button on the toolbar of the tablet. A test document will be sent to the computer.
 - If the **Auto Print** option in the MaxiSys Printer is selected, the MaxiSys printer will automatically print the received document.
 - If the **Auto Print** option in the MaxiSys Printer is not selected, click the **Open PDF File** button to view files. Select the file(s) to be printed and click **Print**.

 **NOTE**

Make sure the computer installed with the Printing Services program is connected to a printer.

8.1.4 Notification Center

This option allows you to turn the Notification Center function on or off. The Notification Center function configures the MaxiSys tablet to receive regular online messages from the server for system update notifications or other service information via the Internet. It is highly recommended that the Notification setting be on at all times so as not to miss news of updates or important service messages. Internet access is required for receiving online messages.

➤ **To enable the Notification Center function**

1. Tap **Settings** on the MaxiSys Job Menu.
2. Tap **Notification Center** on the left column.
3. Tap **ON/OFF** to enable or disable the Notifications function. If the function is enabled the button displays blue, or if disabled the button displays gray.
4. Tap **Home** on the top left corner to return to the MaxiSys Job Menu. Or select another setting option for the system setup.

When the Notification Center function is turned on, and new messages are received by the MaxiSys device, a notification message displays on the MaxiSys Job Menu. Press on the message bar and drag it down to display a list of received messages. Slide the list up or down to view additional messages if present.

Tap a specific message to launch the corresponding application. For example, if you tap on an Update notification message, the Update application will be launched.

8.1.5 Auto Update

This option allows you to preset a time to update the software. There are three update options: OS Update, MaxiSys Update and Vehicle Update.

Tap **ON/OFF** to enable Auto Update. The button displays blue if Autel Update is enabled and displays grey if the Auto Update is disabled. Set the time of the day for updating. If a specific time is set, the selected software will be automatically updated at this specific time.

8.1.6 ADAS Registration

➤ To active MaxiSys ADAS Calibration

1. Confirm that updates for the registered MaxiSys tablet are available.
2. Select **Settings** from the main screen.
3. Click on **ADAS Registration**.
4. Scan the QR code on the ADAS frame to bind, or manually input frame serial number when QR code is not available.
5. Enter the verification code from the ADAS Calibration Card.
6. The system will reset and the main screen will display once registration has been completed.

8.1.7 Vehicle List

This option allows you to sort the vehicles either by alphabetic order or by frequency of use.

➤ To adjust the vehicle list setting

1. Tap the **Settings** application on the MaxiSys Job Menu.
2. Select **Vehicle list** on the left column.
3. Select the required sort type. A check mark will display to the right of the selected language.
4. Tap the **Home** button in the top left corner to return to the MaxiSys Job Menu. Or select another setting option for system setup.

8.1.8 Country Code

This function provides Wi-Fi channel options for different country regions to ensure reliable and stable Wi-Fi communication. Please connect the tablet with VCI device before making adjustment.

➤ To adjust the country code setting

1. Tap the **Settings** application on the MaxiSys Job Menu.
2. Tap the **Country Code** option on the left column.
3. Select the appropriate country region. A message displays to confirm your selection.

4. Tap the **Home** button on the top left corner to return to the MaxiSys Job Menu. Or select another setting option for the system setup.

 **NOTE**

If the tablet can NOT find the VCI device via Wi-Fi connection after setting the country code, please use the USB or Bluetooth connection to retry.

8.1.9 System Settings

This function provides you with direct access to the Android system setting interface, where you can adjust various system settings for the Android system platform, regarding wireless and networks settings, various device settings such as sound and display, as well as system security settings, and check related information about the Android system. Refer to Android documentation for additional information.

8.1.10 About

The About function provides information of the MaxiSys diagnostic device, including the product name, version, hardware, and serial number.

➤ **To check the MaxiSys product information in About**

1. Tap the **Settings** application on the MaxiSys Job Menu.
2. Select the **About** option on the left column. The product information screen displays on the right.
3. Tap the **Home** button on the top left corner to return to the MaxiSys Job Menu, or select another setting option for the system setup, after viewing.

9 Update

The internal programming of the MaxiSys Diagnostic System, known as the firmware, can be updated using the Update application. Firmware updates increase the MaxiSys applications' capabilities, typically by adding new tests, new models, or enhanced applications to the database.

The display device automatically searches for available updates for all of the MaxiSys components when it is connected to the Internet. Any updates that are found can be downloaded and installed on the device. This section describes installing an update to the MaxiSys Diagnostic System firmware. A notification message displays if an update is available when the Notifications function is enabled in the Settings application (See [Notification Center](#) on page 95).

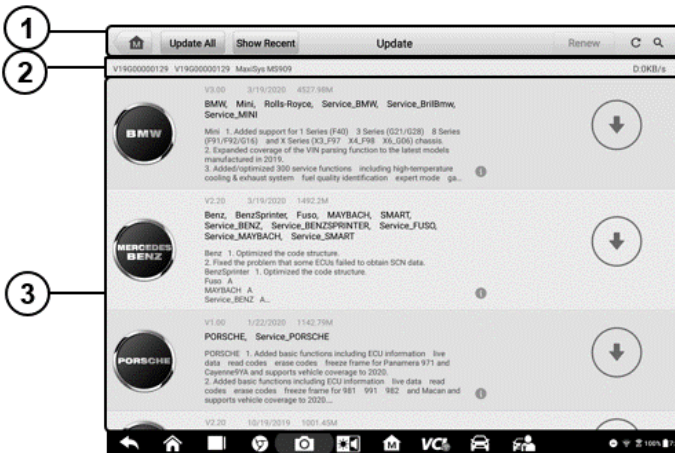

Figure 9-1 Sample Update Screen

1. Navigation and Controls
 - Home Button – return to the MaxiSys Job Menu.
 - Update All – available updates for all tablet systems.
 - Show Recent – shows the recent updates.
 - Search Bar – searches specific update item by inputting the file name, for example: a specific vehicle manufacturer.
2. Status Bar
 - Left Side – displays the MaxiSys device model information and serial number.
 - Right Side – displays an update progress bar indicating the completion status.
3. Main Section
 - Left Column – displays vehicle logos and update firmware version information.

- Middle Column – displays a brief introduction about the new changes to the firmware operation or capabilities. Tap ⓘ button to display an information screen to view more details, and tap the dim area around to close the window.
- Right Column – according to the operation status of each firmware item, the button displays differently.
 - a) Tap Update to update the selected item.
 - b) Tap Pause to suspend the updating procedure.
 - c) Tap Continue to go on updating the suspended update.

➤ **To update the firmware**

1. Power up the tablet, and ensure that it is connected to a power source and has a steady Internet connection.
2. Tap the **Update** application button from the MaxiSys Job Menu; or tap the update notification message when received. The Update application screen displays.
3. Check all available updates:
 - If you decide to update all the items, tap the **Update All** button.
 - If you only want to update some individual items, tap the **Update** button on the right column of the specific item. This option is highly recommended to ensure updates are performed correctly, especially if unsure of the speed and stability of your shops Internet connection.
4. Tap the **Pause** button to suspend the updating process. Tap **Continue** to resume the update and the process will continue from the pause point.
5. When the updating process is completed, the firmware will be installed automatically. The new version will replace the older version.

10 VCI Manager

VCI Manager is for connecting the MaxiSys MS909 tablet with a VCI device through Wi-Fi or Bluetooth. This application allows you to pair the tablet with the VCI device and to check the communication status. You can either build the connection via the Bluetooth or Wi-Fi, of which the latter is more stable and faster in speed for module operation.

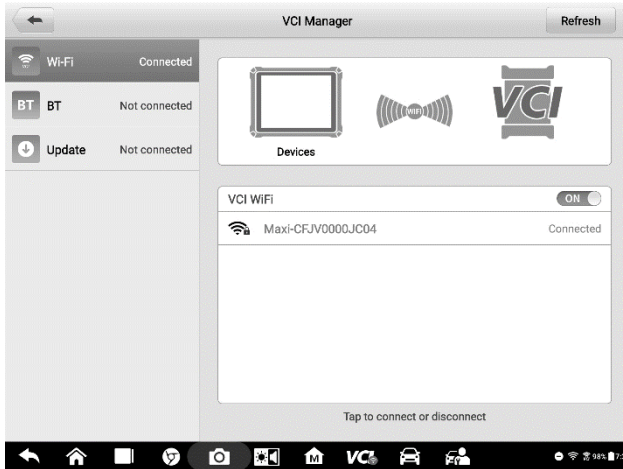

Figure 10-1 Sample VCI Manager Screen

- 1. Connection Mode** – three connection modes are available. The connection status displays adjacent to each mode.
 - Wi-Fi Connection – when connected to a wireless device, the connection state displays as connected, otherwise it displays as Not Connected.
 - BT Pairing – when paired to a wireless device, the connection state displays as Connected; otherwise it displays as Not Connected.
 - Update (for VCI software only) – updates VCI software via Internet through the MaxiSys tablet using USB connection.
 - Select a connection mode to manage and set up connection.
- 2. Settings** – this section allows you to manage wireless pairing or set up network connection.
 - Wi-Fi Setting – searches and displays the type and partial serial number of all devices available for Wi-Fi connection.
 - BT Setting – searches and displays the type and partial serial number of devices available for pairing. Tap a device to start pairing. The BT status icon displays the received signal strength for the device.

- Ethernet Setting – allows you to perform network configuration.

10.1 Wi-Fi Connection

Wi-Fi Connection is an advanced function for quick linkage with VCI. Since Wi-Fi connection supports 5G, the MaxiSys MS909 tablet and VCI share a faster and more stable connection when using this communication method. The tablet can be operated up to 50 meters away from the VCI device when connected to the vehicle.

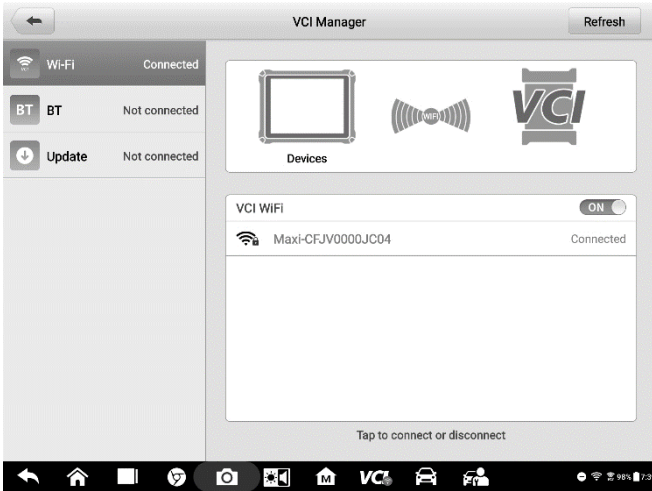

Figure 10-2 Sample Wi-Fi Connection Screen

- **To connect the VCI device with the tablet via Wi-Fi connection**
 1. Power on the tablet.
 2. Connect the 26-pin end of the data cable to the VCI's vehicle data connector.
 3. Connect the 16-pin end of the data cable to the vehicle data link connector (DLC).
 4. Tap **VCI Manager** on the MaxiSys Job Menu of the tablet.
 5. Select **Wi-Fi** from the connection mode list.
 6. Tap the Wi-Fi Toggle to turn it **ON**. Tap **Refresh** at the top right corner. The device will start to search for available units.
 7. Depending on the VCI type you use, the device name may display as Maxi suffixed with a serial number. Select the appropriate device for connection.
 8. When connection is established, the connection status displays as Connected.
 9. The VCI button on the system Navigation bar at the bottom of the screen displays a green Wi-Fi icon, indicating the tablet is connected to the VCI device.
 10. To disconnect the device, tap the connected device listing again.
 11. Tap **Back** on the top left to return to the MaxiSys Job Menu.

NOTE

To ensure quick connection, please perform this operation in a steady network environment.

10.2 BT Pairing

BT Pairing is the basic way for wireless connection. The VCI device needs to be either connected to a vehicle or to an available power source, so that it is powered up during the synchronization procedure. Make sure the tablet has a charged battery or is connected to an AC/DC power supply.

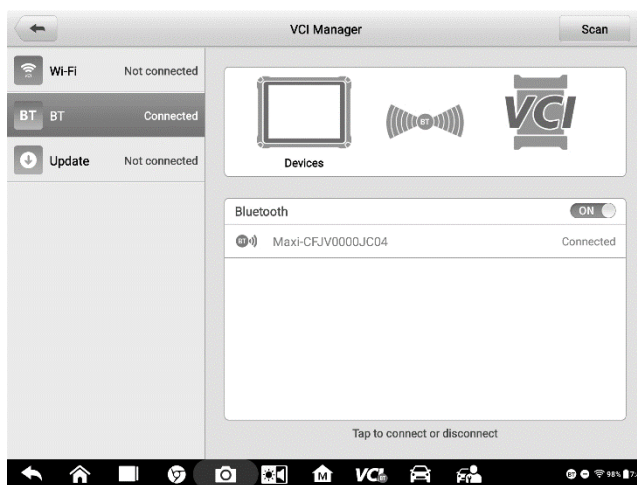

Figure 10-3 Sample BT Pairing Screen

➤ **To pair the VCI device with the tablet**

1. Power on the tablet.
2. Connect the 26-pin end of the data cable to the VCI's vehicle data connector.
3. Connect the 16-pin end of the data cable to the vehicle data link connector (DLC).
4. Tap **VCI Manager** on the MaxiSys Job Menu of the tablet.
5. Select **BT**, short for Bluetooth, from the connection mode list.
6. Tap the Bluetooth toggle to turn it **ON**. Tap **Scan** at the top right corner. Now the device starts searching for available pairing units.
7. Depending on the VCI type you use, the device name may display as Maxi suffixed with a serial number. Select the required device for pairing.

8. When paired successfully, the connection status displays as Connected.
9. Wait a few seconds, and the VCI button on the system Navigation bar at the bottom of the screen displays a green check mark, indicating the tablet is connected to the VCI device.
10. To disconnect the device, tap the connected device listing again.
11. Tap **Back** on the top left to return to the MaxiSys Job Menu.

NOTE

A VCI device can be paired to only one tablet at a time, and once it's been paired, the device will not be discoverable by any other unit.

10.3 Update

The Update module provides the latest update for the MaxiSys MS909 tablet. Before updating the VCI software, please make sure the tablet network is stable.

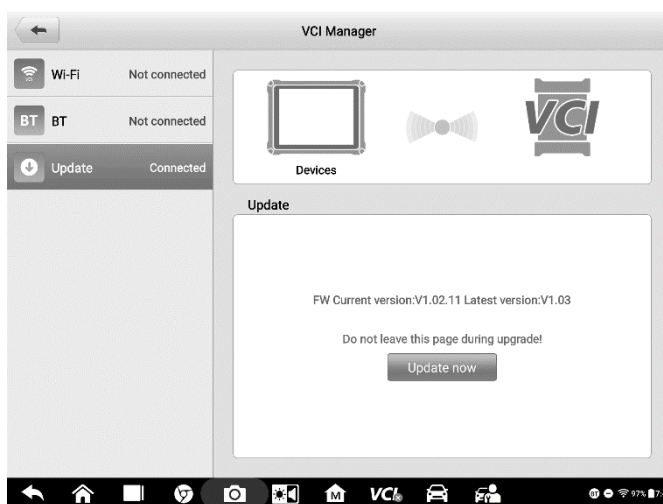

Figure 10-4 Sample VCI Update Screen

➤ To update the VCI software

1. Power on the tablet.
2. Connect the VCI device to the tablet via USB.
3. Tap **VCI Manager** on the MaxiSys Job Menu of the tablet.
4. Select **Update** from the connection mode list.
5. The current version and the latest version of the VCI software will display. Tap **Update Now** to update the VCI software.

11 ADAS

Advanced Driver Assistance Systems (ADAS) is an array of vehicle systems that aid the driver either through passive alerts or by active control of the vehicle to drive safer and with greater awareness and precision.

Cameras, sensors, ultrasound, radar and LIDAR are some of the systems used to capture the driving environment data, including travelling or static vehicles position, pedestrian location, road sign, driving lane and intersection detection, road (curves) and driving conditions (poor visibility or evening driving), use that information to instruct the vehicle to take its predetermined action. Cameras, sensors and sensing systems are typically located in front and rear bumpers, windshield, front grill and side and rear view mirrors.

Autel ADAS Calibration Tool provides comprehensive and precise ADAS calibration.

1. Covers many vehicle makes, including Benz, BMW, Audi, Volkswagen, Porsche, Infiniti, Lexus, GM, Ford, Volvo, Toyota, Nissan, Honda, Hyundai, and Kia.
2. Supports the calibration of multiple driver assistant systems, including Adaptive Cruise Control (ACC), Night Vision System (NVS), Lane Departure Warning (LDW), Blind Spot Detection (BSD), Around View Monitoring (AVM), Rear Collision Warning (RCW) and Heads-up Displays (HUD).
3. Supplies graphic illustrations and step-by-step instructions.
4. Provides demos to guide the technician through the calibration.

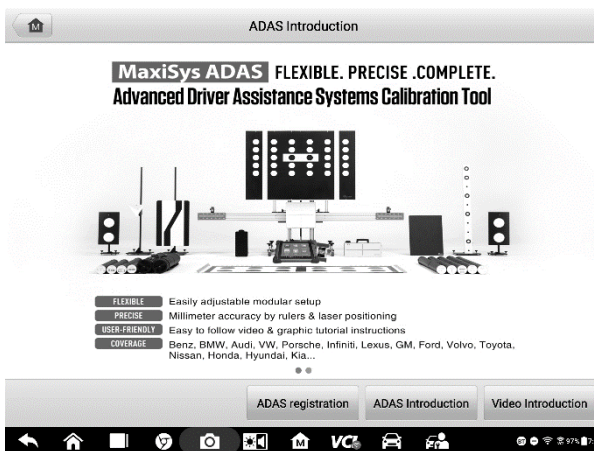

Figure 11-1 Autel ADAS Introduction Screen

12 Support

This application launches the Support platform which synchronizes Autel's online service base station with the MaxiSys tablet. In order to synchronize the device to your online account, you need to register the product through the Internet when you use it for the first time. The Support application is connected to Autel's service channel and online communities that provides the quickest way for problem solutions, allowing you to submit complaints or send help requests to obtain direct service and support.

12.1 Product Registration

In order to get access to the Support platform and obtain update and other services from Autel, you are required to register the MaxiSys Diagnostic Device the first time you use it.

➤ To register the diagnostic device

1. Visit the website: <http://pro.autel.com>.
2. If you have an Autel account, Sign In with your account ID and password.
3. If you are a new member to Autel, click on the **Create Autel ID** button on the left side to create an ID.
4. Enter the required information in the input fields, and click **Get Verification Code** button to get the verification code for email validation.
5. The online system will automatically send a verification code to the registered email address. Input the code in the Verification Code field and fill in the other input fields, read through Autel's Terms and Conditions and click on **Agree**, and then click **Create Autel ID** at the bottom. A product registration screen will display.
6. The device's serial number and password is located in the [About](#) section of the Settings application on the tablet.
7. Select your product model, enter the product serial number and password on the Product Registration screen, and tap **Submit** to complete the registration procedure.

12.2 Support Screen Layout

The Support application interface is navigated by the Home Button on the top navigation bar.

- Home Button – returns to the MaxiSys Job Menu.

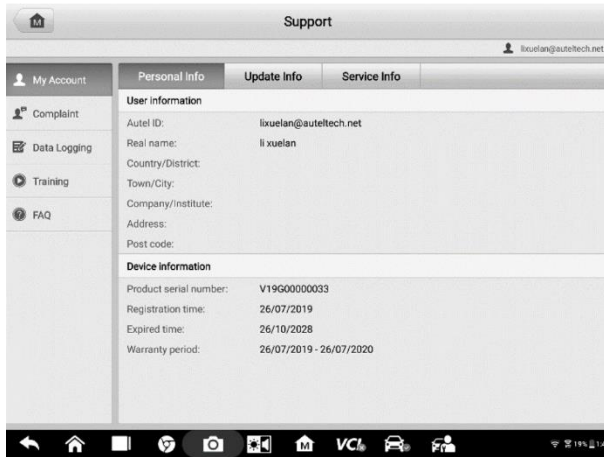

Figure 12-1 Sample Support Application Screen

The main section of the Support screen is divided into two sections. The narrow column on the left is the main menu; selecting one subject from the main menu displays the corresponding functional interface on the right.

12.3 My Account

The My Account screen displays the comprehensive information of the user and the product, which is synchronized with the online registered account, including User Info, Device Info, Update Info and Service Info.

12.3.1 Personal Info

The User Info and Device Info are both included under the Personal Info section.

- User Info – displays detailed information of your registered online Autel account, such as your Autel ID, Name, Address and other contact information.
- Device Info – displays the registered product information, including the Serial Number, Registration Date, Expire Date, and Warranty Period.

12.3.2 Update Info

The Update Info section displays a detailed list of the product's software update history, including the product serial number, software version or name, and the update time.

12.3.3 Service Info

The Service Info section displays a detailed record list of the device's service history information. Every time the device has been sent back to Autel for repair, the device's serial number and the detailed repair information, such as the fault type, changed components, or system reinstallation will be recorded and updated to the associated online product account that will be synchronized to the Service Info section.

12.4 Complaint

The Complaint screen allows you to establish a new complaint case, as well as to view historical complaint records.

12.4.1 Screen Layout

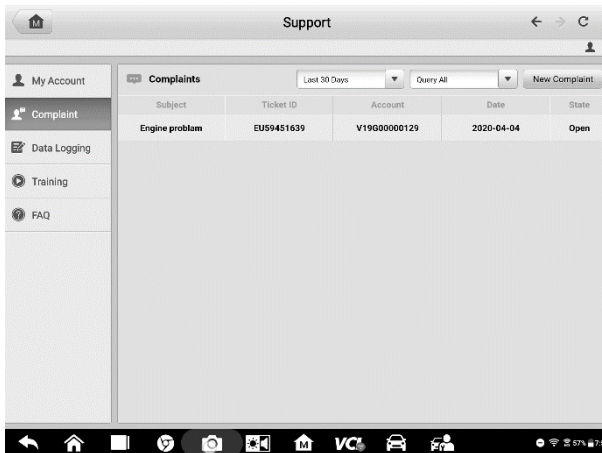

Figure 12-2 Sample Complaint Screen

Complaint List

The complaint list normally displays all the complaint records and their status by default. The summary information for each complaint item includes the Subject Name, Ticket ID, User's Account ID, Date, and the Case Status.

There are two kinds of case status:

- Open – indicates the complaint case has been started but not processed yet.
- Closed – indicates the complaint case has been processed, solved, and ended.

➤ **To establish a new complaint session**

1. Register the product online.
2. Tap **Support** on the MaxiSys Job Menu. The device information is automatically synchronized with the online account.
3. Tap **Complaint** on the Main Menu.
4. Tap **New Complaint** at the upper right corner. A selection menu with a category of service channels displays.
5. Select your target service channel and click **Next** to continue. A standard complaint form displays, on which you are allowed to enter detailed information, such as personal information, vehicle information, and device information, you can also attach image or PDF files with the form.
6. Enter in each input field the appropriate information. To settle the complaint more efficiently, it is recommended to complete the form with as much as detail as possible.
7. Select the required processing time on the last section according to the urgency of the case.
8. Tap **Submit** to send the completed form to Autel's online service center. The submitted complaints will be carefully read and handled by the service personnel.

12.5 Data Logging

The Data Logging section keeps records of all **Feedback** (submitted), **Not Feedback** (but saved) or **History** (up to the latest 20 test records) data loggings on the diagnostic system. The support personnel will receive and process the submitted reports through the Support platform. The solution will be sent back within 48 hours. You may continue to correspond with Support until the issue is resolved.

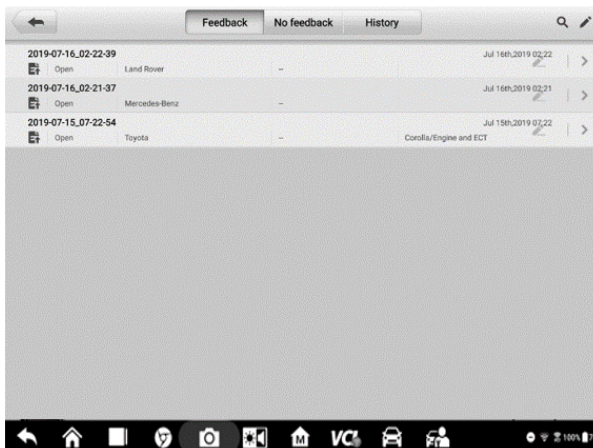

Figure 12-3 Sample Data Logging Screen

➤ **To make a reply in a Data Logging session**

1. Tap the **Feedback** tab to view the submitted data loggings.
2. Select the latest message from Autel support service.
3. Tap the input field at the bottom of the screen, and enter your reply. Or tap the Audio button to record a voice message, or tap the camera button to take a screenshot.
4. Tap **Send** to send your reply to Support.

12.6 Training

The Training section provides quick links to Autel's online video accounts. Select a video channel by language to see all available Autel online tutorial videos on such topics as product usage techniques and vehicle diagnostics practices.

12.7 FAQ Database

The FAQ section provides comprehensive references for all questions frequently asked and answered about the use of Autel's online member account, shopping and payment procedures.

- Account – displays questions and answers about the use of Autel's online user account.
- Shopping & Payment – displays questions and answers about online product purchase and payment methods or procedures.

13 Remote Desktop

The Remote Desktop application launches the TeamViewer Quick Support program, which is a simple, fast and secure remote control interface. You can use the application to receive ad-hoc remote support from Autel's support center, colleagues, or friends, by allowing them to control your MaxiSys tablet on their PC via the TeamViewer software.

13.1 Operations

If you think of a TeamViewer connection as a phone call, the TeamViewer ID would be the phone number under which all TeamViewer Clients can be reached separately. Computers and mobile devices that run TeamViewer are identified by a globally unique ID. The first time the Remote Desktop application is started, this ID is generated automatically based on the hardware characteristics and will not change.

Make sure the tablet is connected to the Internet before launching the Remote Desktop application, so that the tablet is able to receive remote support from the third party.

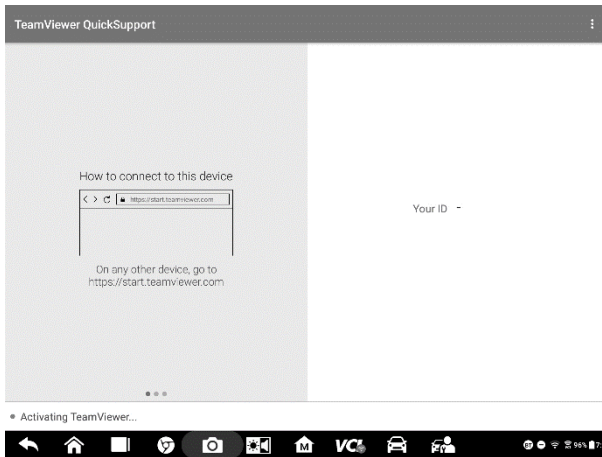

Figure 13-1 Remote Desktop Screen

➤ **To receive remote support from a partner**

1. Power on the tablet.
2. Tap the **Remote Desktop** application on the MaxiSys Job Menu. The TeamViewer interface displays and the device ID is generated and shown.
3. Your partner must install the Remote Control software to his/her computer by downloading the TeamViewer full version program online

(<http://www.teamviewer.com>). Start the software on his/her computer at the same time, in order to provide support and take control of the tablet remotely.

4. Provide your ID to the partner, and wait for him/her to send you a remote control request.
5. A message displays to ask for your confirmation to allow remote control on your device.
6. Tap **Allow** to accept, or tap **Deny** to reject.

Refer to the associated TeamViewer documents for additional information.

14 Quick Link

The Quick Link application provides you with convenient access to Autel's official website and many other well-known sites in automotive service, which offers you abundant information and resources, such as technical help, knowledge bases, forums, training and expert consultations.

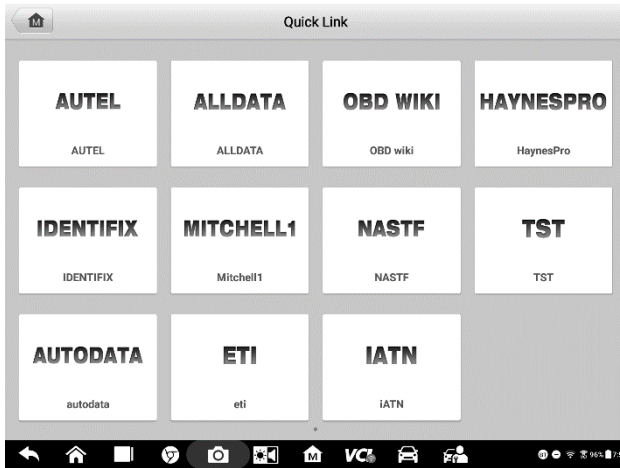

Figure 14-1 Quick Link

➤ To open a quick link

1. Tap **Quick Link** on the MaxiSys Job Menu. The Quick Link application screen displays.
2. Select a website thumbnail from the main section. The Chrome browser is launched and the selected website is opened.
3. Now you can start exploring the website!

15 MaxiViewer

MaxiViewer allows you to search for functions supported by our tools and the version information. There are two ways of searching, either by searching the tool and the vehicle or searching the functions.

➤ **To search by vehicle**

1. Tap the **MaxiViewer** application on the MaxiSys Job Menu. The MaxiViewer application screen displays.
2. Tap the tool name on the top left to drop down the tool list, tap the one you want to search.
3. Tap the vehicle brand, model, and year you want to search.

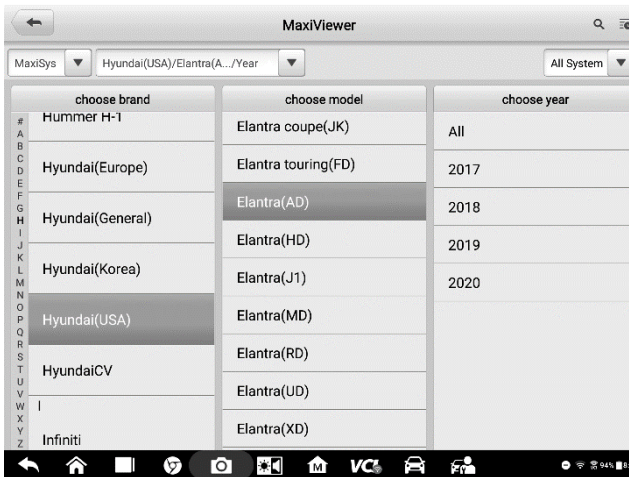

Figure 15-1 Sample MaxiViewer Screen 1

4. All the functions supported by the selected tool for the selected vehicle display within three columns, function, sub function, and version.

The screenshot shows the MaxiViewer application interface. At the top, there is a search bar with a magnifying glass icon and a list icon. Below the search bar, there are three dropdown menus: 'MaxiSys' (set to 'Hyundai(USA)/Elantra(A.../Year'), 'System' (set to 'System'), and 'Capacity' (set to 'Capacity'). To the right of these is another dropdown menu labeled 'Type'. Below these filters is a table with the following columns: Year, System, Capacity, Type, Function, Sub function, and Version. The table contains six rows of data, all with 'Year' 2020 and 'Type' 'sedan car'. The 'Function' column lists 'Special functions' for all rows. The 'Sub function' column lists 'Resetting Adaptive Values', 'Resetting Adaptive Values', 'Write VIN', 'Write VIN', 'Auto Detected Configuration Reset', and 'Auto Detected Configuration Reset'. The 'Version' column lists 'Above Hyundai_V8.00' for all rows. At the bottom of the screen is an Android-style navigation bar with icons for back, home, recent apps, search, camera, gallery, home, VCL, car, and user profile, along with a battery level indicator at 94%.

| Year | System | Capacity | Type | Function | Sub function | Version |
|------|--------|-------------|-----------|-------------------|-----------------------------------|---------------------|
| 2020 | Engine | G 2.0 MPI | sedan car | Special functions | Resetting Adaptive Values | Above Hyundai_V8.00 |
| 2020 | Engine | G 1.6 T-GDI | sedan car | Special functions | Resetting Adaptive Values | Above Hyundai_V8.00 |
| 2020 | Engine | G 2.0 MPI | sedan car | Special functions | Write VIN | Above Hyundai_V8.00 |
| 2020 | Engine | G 1.6 T-GDI | sedan car | Special functions | Write VIN | Above Hyundai_V8.00 |
| 2020 | Engine | G 2.0 MPI | sedan car | Special functions | Auto Detected Configuration Reset | Above Hyundai_V8.00 |
| 2020 | Engine | G 1.6 T-GDI | sedan car | Special functions | Auto Detected Configuration Reset | Above Hyundai_V8.00 |

Figure 15-2 Sample MaxiViewer Screen 2

➤ **To search by the functions**

1. Tap the MaxiViewer application on the MaxiSys Job Menu. The MaxiViewer application screen displays.
2. Tap the tool name on the top left to drop down the tool list, tap the one you want to search.
3. Enter the function you want to search in the top right search box. The screen will display all vehicles that support this function, along with information such as the vehicles' year, system, capacity, type, function, sub-function, and version.

NOTE

Fuzzy search is supported, type in some part of the function-related keywords to find all the available information.

16 MaxiVideo

The MaxiVideo application configures the MaxiSys Diagnostic Device to operate as a digital video scope by simply connecting the tablet to a MaxiVideo Camera. This function allows you to examine difficult-to-reach areas normally hidden from sight, with the ability to record digital still images and videos, which offers you an economical solution to inspect machinery, facilities, and infrastructure in a safe and quick way.

WARNINGS & IMPORTANTS:

Follow these instructions to reduce the risk of injury from electric shock, entanglement and other causes and prevent tool damage.

- Do not place the imager head into anything or anywhere that may contain a live electric charge or moving parts, which increases the risk of electric shock or entanglement injuries.
- Do not use the imager head cable to modify surroundings, clear pathways or clogged areas.
- When inspection is completed, carefully withdraw the imager head from the inspected area.
- The imager head cable is waterproof to a depth of 3m (10'), greater depths may cause leakage into the imager head cable, electric shock or tool damage.
- The working temperature of the imager head is between 32 °F (0 °C) and 113 °F (45 °C).

Check-Ups:

- ✓ **FOR AUTOMOBILES:** Ensure the automobile is not running during inspection to avoid damage from hot metal and liquid under the hood. Do not get oil or gasoline on the imager head.
- ✓ **FOR PIPES:** If you suspect that a metal pipe may carry electric charge, have a qualified electrician to check the pipe before inspecting it.
- ✓ **FOR WALLS:** Before you inspect the inside of a wall with the imager head, turn off the circuit breaker to the house.
- ✓ **WORK AREA:** Ensure the work area has sufficient light.

16.1 Additional Accessories

The MaxiVideo Camera and its fittings are the additional accessories. Both sizes (8.5 mm and 5.5 mm) of the imager head are optional and available for purchase along with the standard MaxiSys tool kit.

16.1.1 MaxiVideo Camera

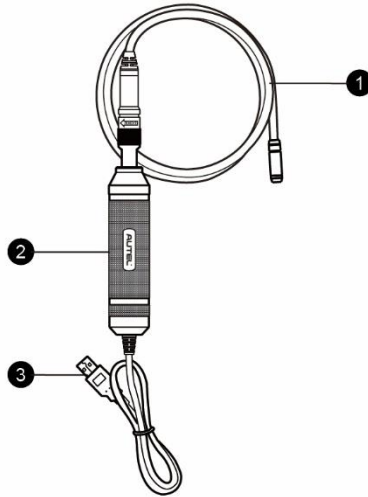

Figure 16-1 MaxiVideo Camera

1. Removable Imager Head Cable – connects to the tool when performing MaxiVideos for image and video viewing.
2. Handgrip – ergonomically designed handle for comfortable grips and agile operation.
3. USB Cable – connects the MaxiVideo Camera to the MaxiSys tablet.

16.1.2 Imager Head Accessories

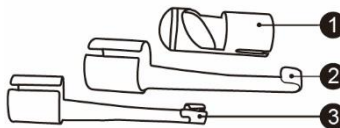

Figure 16-2 8.5mm Imager Head Accessories

1. Magnet – picks up small metal objects such as dropped rings or screws.
2. Hook – unclogs obstacles and picks up wires in the pipes or confined areas.
3. Mirror – helps to look around corners and see the unreachable areas.

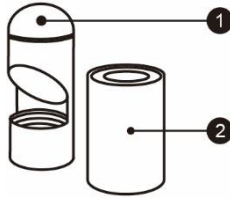

Figure 16-3 5.5mm Imager Head Accessories

1. Mirror – helps to look around corners and see the unreachable areas.
2. Magnet – picks up small metal objects, such as dropped rings or screws.

16.1.3 Accessory Assembly

16.1.3.1 For 8.5mm Imager Head

The three accessories, including the Magnet, Hook, and Mirror, can be attached to the Imager Head in the same manner described below:

1. Hold the accessory and the imager head.

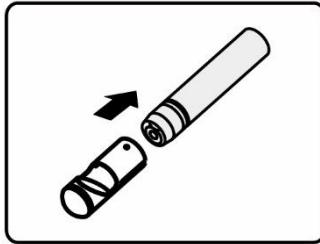

2. Slip the end of the accessory over the imager head and then fix the accessory.

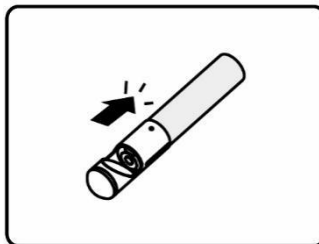

16.1.3.2 For 5.5mm Imager Head

The two accessories, including the Magnet and Mirror, can be attached to the Imager Head in the same manner described below:

1. Hold the accessory and the imager head.

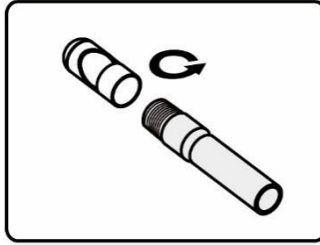

2. Screw the thread part of the accessory over the imager head to fix the accessory.

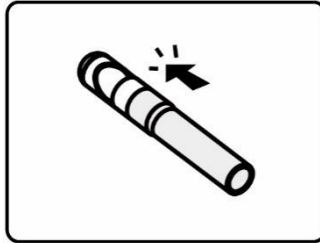

16.1.4 Technical Specifications

Table 16-1 Specifications

| Item | Description |
|---------------------------------|---|
| Optimal Viewing Distance | 1" to 14" (2.54cm to 35.56cm) with 8.5mm-diameter imager head 3/8" to 12" (0.95cm to 30cm) with 5.5mm-diameter imager head |
| Resolution | JPG images (640x480) AVI videos (320 x 240) |
| Operating Temperature | Main Unit: 0°C to 55°C (ambient) Cable: -10°C to 70°C |
| Storage Temperature | -20°C to 75°C (ambient) |
| Waterproof | Imager head and cable to 1m |
| Weight | 0.3 kg for 8.5 mm diameter imager head 0.2 kg for 5.5 mm diameter imager head |

16.2 Operations

Before opening the MaxiVideo application, the imager head cable must be connected to the tablet through the USB port. Install the correct imager head accessories according to the specific needs.

NOTE

When in operation, the imager head cable can be manipulated so as to better access confined or awkward spaces.

➤ **To take images using the MaxiVideo application**

1. Connect the imager head cable to the USB port on the top of the tablet.
2. If not already done, power up the tablet.
3. Tap the **MaxiVideo** application on the MaxiSys Job Menu. The MaxiVideo interface displays, showing a camera operating screen. The imager head camera is used by default.
4. Select the **Camera** icon at the lower right corner to take images.
5. Focus the image to be captured in the view finder by adjusting and properly locating the imager head cable.
6. Tap the blue ring on the screen. The view finder now displays the captured picture and auto-saves the taken photo.
7. Tap the thumbnail image on the top right corner of the screen to view the stored image, slide the screen left and right to view the images.
8. Tap on the selected image and the edit toolbar instantly displays.
9. Tap the corresponding button to **share** or **delete** an image.
10. Tap the **Back** or **Home** button on the Navigation bar at the bottom of the screen to exit the MaxiVideo application.

➤ **To record a video using the MaxiVideo application**

1. Connect the imager head cable to the USB port on the top side of the tablet.
2. If not already done, power up the tablet.
3. Tap the **MaxiVideo** application on the MaxiSys Job Menu. The MaxiVideo interface displays, showing a camera operating screen. The Imager head camera is used by default.
4. Select the **Video** icon at the lower right corner to record a video.
5. Properly locate the imager head cable to focus the inspection scene for recording.
6. Tap the red ring on the operating screen to start recording.
7. Tap the red circle again to stop recording. The recorded video is automatically saved.
8. Tap the gallery icon at the bottom right corner to review all the recorded videos.

9. Select the corresponding button on the upper right corner to search or delete a video.

17 Maintenance and Service

To ensure that the tablet and the combined VCI unit perform at their optimum level, we advise that the product maintenance instructions in this section are strictly followed.

17.1 Maintenance Instructions

The following includes how to maintain your devices, together with precautions to take.

- Use a soft cloth dampened with alcohol or mild glass cleaner to clean the tablet touchscreen at the end of each work day.
- Do not use any abrasive cleansers, detergent, or automotive chemicals on the tablet.
- Keep the devices in dry conditions and within specified operating temperatures.
- Dry your hands before using the tablet. The touchscreen of the tablet may not work when it is moist, or when you tap the touchscreen with wet hands.
- Do not store the devices in humid, dusty or dirty areas.
- Check the housing, wiring, and connectors for dirt and damage before and after each use.
- Do not attempt to disassemble your tablet or the VCI unit.
- Do not drop or cause severe impact to the devices.
- Use only authorized battery chargers and accessories. Any malfunction or damage caused by the use of unauthorized battery charger or accessories will void the limited product warranty.
- Ensure that the battery charger does not contact conductive objects.
- Do not use the tablet beside microwave ovens, cordless phones and certain medical or scientific instruments to prevent signal interference.

17.2 Troubleshooting Checklist

- A. When the tablet does not work properly:
- Make sure the tablet has been registered online.
 - Make sure the system software and diagnostic application are properly updated.
 - Make sure the tablet is connected to the Internet.
 - Check all cables, connections, and indicators to see if the signal is being received.
- B. When battery life is shorter than usual:
- This may happen when you are in an area with low signal strength. Turn off your device if it is not in use.

C. When you cannot turn on the tablet:

- Make sure the tablet is connected to a power source or the battery is charged.

D. When you are unable to charge the tablet:

- Your charger maybe out of order. Contact your nearest dealer.
- You may be attempting to use the device in an overly hot/cold temperature. Charge the device in a temperate area.
- Your device may not be connected to the charger properly. Check the connector.

 **NOTE**

If the problems persist, please contact Autel's technical support personnel or your local selling agent.

17.3 About Battery Usage

Your tablet is powered by a built-in lithium-ion polymer battery, which enables you to recharge your battery when there is electricity left.

 **DANGER**

The built-in lithium-ion polymer battery is factory-replaceable only; incorrect replacement or tampering with the battery pack may cause an explosion.

- Do not use a damaged battery charger.
- Do not disassemble, open, crush, bend, deform, puncture, or shred the battery.
- Do not modify, remanufacture or attempt to insert foreign objects into the battery, or expose the battery to fire, explosion, or other hazards.
- Only use the specified charger and USB cables. Use of non-Autel-authorized charger or USB cables may lead to device malfunction or failure.
- Use of an unqualified battery or charger may present a risk of fire, explosion, leakage, or other hazards.
- Avoid dropping the tablet. If the tablet is dropped, especially on a hard surface, and you suspect damage, take the tablet to a service center for inspection.
- Try to keep closer to your wireless router to reduce battery usage.
- The time needed to recharge the battery varies depending on the remaining battery capacity.
- Battery life inevitably shortens over time.
- Unplug the charger once the tablet is fully charged since overcharging may shorten battery life.
- Keep the battery in temperate environments. Do not place it inside a car when it is too hot or too cold, which may reduce the capacity and life of the battery.

17.4 Service Procedures

This section provides information on technical support, repair service, and application for replacement or optional parts.

17.4.1 Technical Support

If you have any question or problem on product operations, please contact us.

AUTEL NORTH AMERICA

- **Phone:** 1-855-AUTEL-US (855-288-3587) Monday-Friday 9am-6pm EST
- **Website:** www.autel.com
- **Email:** sales@autel.com; ussupport@autel.com
- **Address:** 175 Central Avenue, Suite 200, Farmingdale, New York, USA 11735

AUTEL EUROPE

- **Phone:** 0049 (0) 6103-2000520
- **Website:** www.autel.eu
- **Email:** sales.eu@autel.com; support.eu@autel.com
- **Address:** Robert-Bosch-Strasse 25, 63225, Langen, Germany

AUTEL CHINA HQ

- **Phone:** 0086-755-2267-2493
- **Website:** sales@auteltech.net; www.autel.com
- **Email:** support@autel.com
- **Address:** 7-8th, 10th Floor, Building B1, Zhiyuan, Xueyuan Road, Xili, Nanshan, Shenzhen, 518055, China

AUTEL LATIN AMERICA

- **Website:** www.autel.com
- **Email:** sales.latin@autel.com; latsupport@autel.com
- **Address:** Avenida Americas 1905, 6B, Colonia Aldrete, Guadalajara, Jalisco, Mexico

AUTEL APAC

- **Phone:** +045 5948465
- **Email:** sales.jp@autel.com; support.jp@autel.com
- **Address:** 719, Nissou Building, 3-7-18, Shinyokohama, Kouhoku, Yokohama, Kanagawa, Japan 222-0033
- **Website:** www.autel.com/jp/

AUTEL IMEA DMCC

- Website: www.autel.com
- Phone: +971 585 002709
- Email: sales.imea@autel.com; imea-support@autel.com
- Address: Office 1006-1010, Cluster C, Fortune Tower, Jumeirah Lakes Tower (JLT), Dubai, U.A.E

For technical assistance in other markets, please contact your local selling agent.

17.4.2 Repair Service

If it is necessary to send back your device for repair, please download and fill out the repair service form from www.autel.com. The following information must be included:

- Contact name
- Return address
- Telephone number
- Product name
- Complete description of the problem
- Proof-of-purchase for warranty repairs
- Preferred method of payment for non-warranty repairs

NOTE

For non-warranty repairs, payment can be made with Visa, Master Card, or with approved credit terms.

Send the device to your local agent, or to the address below:

7-8th, 10th Floor, Building B1, Zhiyuan,
Xueyuan Road, Xili, Nanshan,
Shenzhen, 518055, China

17.4.3 Other Services

You can purchase the accessories directly from authorized tool suppliers of Autel, or your local distributor or agent.

Your purchase order should include the following information:

- Contact information
- Product or part name
- Item description
- Purchase quantity

18 Compliance Information

FCC Compliance

FCC ID: WQ8MAXISYSMS909

This equipment has been tested and verified to comply with the limits for a Class B digital device, pursuant to Part 15 of the FCC Rules. These limits are designed to provide reasonable protection against harmful interference in a residential installation. This equipment generates uses and can radiate radio frequency energy and, if not installed and used in accordance with the instructions, may cause harmful interference to radio communications. However, there is no guarantee that interference will not occur in a particular installation. If this equipment does cause harmful interference to radio or television reception, which can be determined by turning the equipment off and on, the user is encouraged to correct the interference by one or more of the following measures:

- Reorient or relocate the receiving antenna.
- Increase the separation between the equipment and receiver.
- Consult the dealer or an experienced radio/TV technician for help.

This device complies with part 15 of the FCC Rules. Operation is subject to the following two conditions:

- (1) This device may not cause harmful interference, and
- (2) This device must accept any interference received, including interference that may cause undesired operation.

Changes or modifications not expressly approved by the party responsible for compliance could void the user's authority to operate the equipment.

SAR:

The radiated output power of this device is below the FCC radio frequency exposure limits. Nevertheless, the device should be used in such a manner that the potential for human contact is minimized during normal operation.

The exposure standard for wireless devices employs a unit of measurement known as the Specific Absorption Rate, or SAR. The SAR limit set by the FCC is 1.6 W/Kg. Tests for SAR are conducted using standard operating positions accepted by the FCC with the device transmitting at its highest certified power level in all tested frequency bands. Although the SAR is determined at the highest certified power level, the actual SAR level of the device while operating can be well below the maximum value. This is because the device is designed to operate at multiple power levels to use only the power required to reach the network. To avoid the possibility of exceeding the FCC radio frequency exposure limits, human proximity to antenna should be minimized.

19 Warranty

19.1 12-Month Limited Warranty

Autel Intelligent Technology Corp., Ltd. (the Company) warrants to the original retail purchaser of this MaxiSys Diagnostic Device that should this product or any part thereof during normal usage and under normal conditions be proven defective in material or workmanship that results in product failure within twelve (12) months period from the date of purchase, such defect(s) will be repaired, or replaced (with new or rebuilt parts) with Proof of Purchase, at the Company's option, without charge for parts or labor directly related to the defect(s).

The Company shall not be liable for any incidental or consequential damages arising from the use, misuse, or mounting of the device. Some states do not allow limitation on how long an implied warranty lasts, so the above limitations may not apply to you.

This warranty does not apply to:

- a) Products subjected to abnormal use or conditions, accident, mishandling, neglect, unauthorized alteration, misuse, improper installation or repair or improper storage;
- b) Products whose mechanical serial number or electronic serial number has been removed, altered or defaced;
- c) Damage from exposure to excessive temperatures or extreme environmental conditions;
- d) Damage resulting from connection to, or use of any accessory or other product not approved or authorized by the Company;
- e) Defects in appearance, cosmetic, decorative or structural items such as framing and non-operative parts.
- f) Products damaged from external causes such as fire, dirt, sand, battery leakage, blown fuse, theft or improper usage of any electrical source.

! IMPORTANT

All contents of the product may be deleted during the process of repair. You should create a back-up copy of any contents of your product before delivering the product for warranty service.
