



ATD-30335 30" Oscillating Pedestal Fan Owner's Manual



Features:

- Three speed energy efficient oscillating motor
- Automatic shut-off feature prevents overheating
- 1/5 HP Motor
- Up to 4,853 CFM
- Tubular steel stand with round base needs only limited floor space
- Black powder coating for durable use
- Balanced aluminum blades for quiet operation
- Three-speed pull switch
- Easy height adjustment from 63-3/4" to 75-5/8"
- Base wheels for increased mobility
- UL/cUL listed.
- One year limited warranty
- Packaging Dimensions: 39.57" x 32.09" x 8.07"
- Shipping Weight 51 lbs.

General Safety Warnings:

 **WARNING:** The instructions and warnings contained in this manual should be read and understood before using or operating this fan. Do not allow anyone to use or operate this fan until they have read this manual and have developed a thorough understanding of how this fan works. Failure to observe any of the following instructions could result in severe personal injury to fan user and bystanders, or cause damage to the fan and property. Keep this manual for future reference.

 **Note:** The warnings and cautions discussed in this instruction manual cannot cover all possible conditions and situations that may occur. It must be understood by the operator that common sense and caution are factors which cannot be built into this product, but must be supplied by the operator.

Electrical Safety Warnings:

 **WARNING:** Read all safety warnings and instructions. Failure to follow all warnings and instructions may result in electric shock, fire and/or serious injury or death.

 **WARNING:** Before connecting a fan to a power supply, always check to ensure the power supply corresponds to the voltage on the nameplate of the fan. A power supply with a voltage greater than that specified for the fan can result in serious injury to the user, as well as damage to the fan. Using a power supply with a voltage less than the nameplate rating is harmful to the motor. If in doubt, do not plug in the fan.

 **WARNING:** Grounded fans must be plugged into an outlet properly installed and grounded in accordance with all codes and ordinances. This fan is equipped with a 3-prong plug and a 3-wire grounding system. Never remove the grounding prong or modify the plug in any way. Do not use any adapter plugs. Check with a qualified electrician if you are in doubt as to whether the outlet is properly grounded.

 **NOTE:** Double insulated fans are equipped with a polarized plug (one blade is wider than the other). This plug will fit in a polarized outlet only one way. If the plug does not fit fully in the outlet, reverse the plug. If it still doesn't fit, contact a qualified electrician to install a polarized outlet. Do not change the plug in any way.

 **WARNING:** To reduce the risk of electric shock, DO NOT use in damp conditions, on wet surfaces, or expose to rain. Do not plug in this fan or operate it with wet hands or while standing in water.

 **WARNING:** Never use the cord for carrying, pulling or unplugging the fan. Grasp plug and pull to disconnect from outlet. Keep cord away from heat, oil, sharp edges or moving parts. Replace damaged cords immediately.

 **WARNING:** Ensure the switch is in the off position before plugging the fan into the power outlet. In the event of a power failure while the fan is being used, turn the switch off to prevent surprise starting when the power is restored.

 **WARNING:** Always remove the power cord from the electric outlet when making adjustments, changing parts, cleaning or working on the fan.

 **WARNING:** Care should be taken to arrange the cord so it will not be stepped on, tripped over, or otherwise subjected to damage or stress.

 **WARNING:** Never attempt to plug in or operate equipment with defective or damaged wires, power cord or power cord plug. Have any defective or damaged parts replaced immediately by qualified personnel.

 **WARNING:** Avoid body contact with electrically grounded surfaces. There is an increased risk of electric shock if your body is grounded.

 **WARNING:** If the work area is not equipped with a permanently installed Ground Fault Circuit Interrupter outlet (GFCI), use a plug-in GFCI between the fan and the power receptacle.

 **WARNING:** This fan is for **INDOOR** use **ONLY**.

 **WARNING:** Do **NOT** use extension cords with this fan.

 **WARNING:** Never operate this fan without the protective front and rear guards in place. Do not stick anything through the guards that will come in contact with the moving blades (fingers, tools, etc.). Personal injury will result.

 **WARNING:** Never use this fan with any mister or spray attachment of any kind.

Care and Maintenance:

- Unplug the appliance before cleaning.
- Do **NOT** use water directly on the fan for cleaning metal surfaces.
- Slightly moisten a cloth and then wipe off the surfaces of the fan. In order to remove the dust from the grill, use a vacuum cleaner or remove the front grill
- After cleaning, remount the grill.

Assembly Instructions:

1. Connect the lower pole (8) to the base (10) with fasteners (9)
2. Insert the upper adjustable pole (7) into lower pole (8), then adjust it to the height you want by tightening the knob. In the future, you can adjust fan height by loosening & tightening this knob.

PLEASE NOTE THAT ADJUSTABLE SPRING MUST BE PUT INSIDE OF LOWER POLE (8)

3. Mount the motor (5) on upper adjustable pole (7) affix with fasteners (6)
4. Connect the rear guard (4) to motor (5) with washers and nuts.
5. Attach the fan blade (2) onto motor shaft with screw.
6. Connect the front guard (1) with rear guard with clip (4)

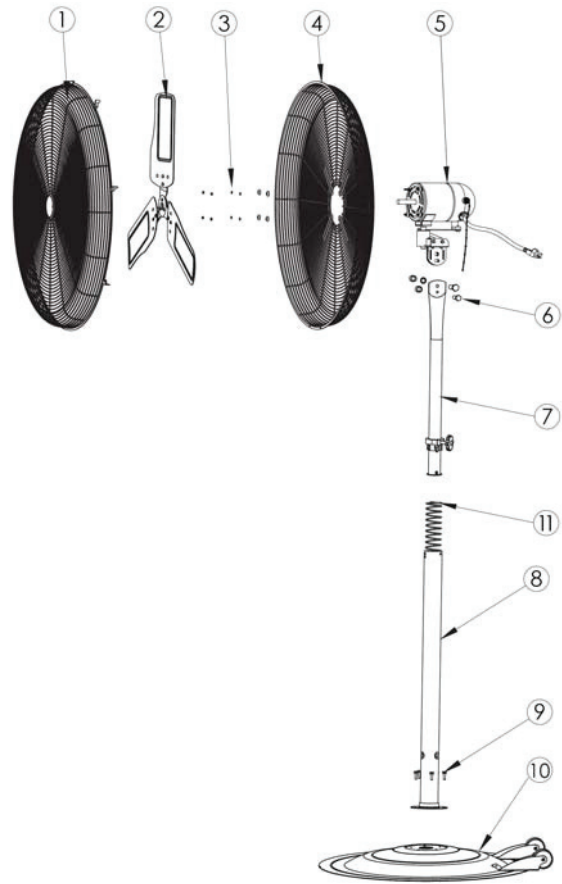

Operating Instructions:

1. Connect power plug to any standard 120V AC outlet. Caution: Make sure control is in the "0"(off) position.
2. The fan has three different speeds. Pull power chain once to operate the low speed and allow to operate for 10 seconds.
3. Once 10 seconds have passed, you can now pull the power chain to the medium or high position.

Oscillation control:

Please note, there are two different holes in which screw will fasten. One for oscillating control, and one for non-oscillating control.

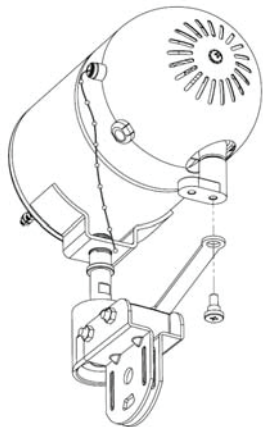

This fastening situation is for
Non-oscillation operation.

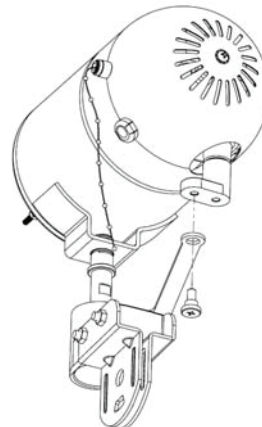

This fastening situation is for
Oscillation operation.



ATD-30335

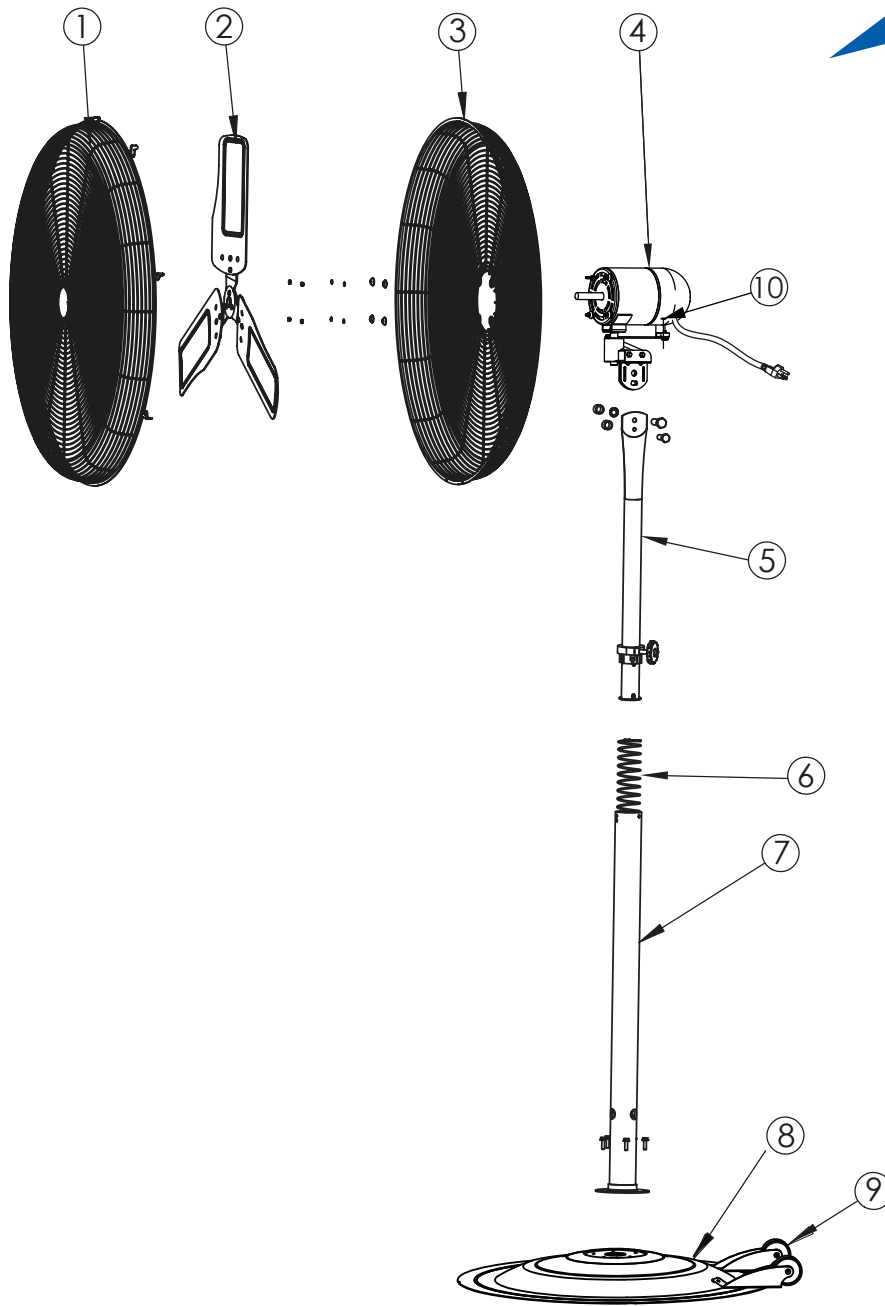

ITEM#	ORDERING PART#	PART DESCRIPTION
1	PRT30330-01	FRONT & REAR GUARD, CED406-ATD-P1
2	PRT30330-02	BLADE, CED406-ATD-P2
3	PRT30330-01	FRONT & REAR GUARD, CED406-ATD-P3
4	PRT30335-04	OCILLATING MOTOR, CED406OSC-ATD-P4
5	PRT30330-05	HEIGHT ADJUSTING POLE, CED406-ATD-P5
6	PRT30330-06	SPRING, CED406-ATD-P6
7	PRT30330-07	STANDING POLE, CED406-ATD-P7
8	PRT30330-08	BASE, CED406-ATD-P8
9	PRT30330-09	WHEELS, CED406-ATD-P9
10	PRT30330-10	PULL SWITCH, CED406-ATD-P10



WARRANTY

1 YEAR LIMITED WARRANTY

THIS WARRANTY AND CONFIRMED RECEIPT(S) SHOULD BE RETAINED BY THE CUSTOMER AT ALL TIMES

PURCHASED FROM: _____

DATE PURCHASED: _____

INVOICE/RECEIPT NUMBER: _____

Your ATD-30335 is warranted for a period of 12 months from the original purchase date.

For a period of one (1) year from your purchase date, ATD Tools Inc. will repair or replace (at its option) without charge, your ATD product if it was purchased new and the product has failed due to a defect in material or workmanship which you experienced during normal use of the product. This limited warranty is your exclusive remedy.

To access the benefits of this warranty, contact your supplier, or point of sale directly. You may be advised to return the product under warranty, freight prepaid, to your supplier for warranty determination.

If this ATD product is altered, abused, misused, modified, or undergoes service by an unauthorized technician, your warranty will be void. We are not responsible for damage to ornamental designs you place on this ATD product and such ornamentation should not cover any warnings or instructions or they may void the warranty. This warranty does not cover scratches, superficial dents, and other abrasions to the paint finish that occur under normal use. It also does not cover normal wear items such as but not limited to brushes, batteries, drill bits, drill chucks, pads or blades.

Subject to the law in your state:

- (1) Your sole and exclusive remedy is repair or replacement of the defective product as described above.
- (2) ATD is not liable for any incidental damages, including but not limited to, lost profits and unforeseeable consequences.
- (3) The repair and replacement of this product under the express limited warranty described above is your exclusive remedy and is provided in lieu of all other warranties, express or implied. All other warranties, including implied warranties and warranties of merchantability or fitness for a particular purpose are disclaimed and, if disclaimer is prohibited, these warranties are limited to one year from your date of purchase of this product.

Some states' laws do not allow limited durations on certain implied warranties and some states' laws do not allow limitations on incidental or consequential damages. You should consult the law in your state to determine how your rights may vary.

[Affix receipt or invoice here for safe keeping]